

Der neue WMF Chafing Dish HOT & FRESH GN 1/1. Der große Buffet-Hotspot. Mit dem richtigen Durchblick.

The brand new WMF HOT & FRESH chafing dish GN 1/1.
The big player on your buffet. With the good looks to show.



NEU | NEW

Der neue WMF HOT & FRESH GN 1/1 beweist Größe in seiner Kategorie. Er leistet sowohl mit Induktionsheizung als auch auf jeder anderen Standard-Wärmequelle tadellose Arbeit. Mit seinem transparenten Glasdeckel sieht er nicht nur gut aus. Er lässt auch die Speisen bestmöglich im Blick behalten. Hitzebeständige Griffe und gastronomietaugliche Materialien erleichtern die Arbeitsabläufe.

The new WMF HOT & FRESH GN 1/1 works perfectly with induction heating or with any other commonly used heat source. The lid is clear glass, so it doesn't just look good, it allows an excellent view of the food as well. Heat-resistant handles and catering-grade materials help keep workflows progressing smoothly.



Buffetgestell NEUTRAL
buffet stand NEUTRAL



Buffetgestell MANHATTAN
buffet stand MANHATTAN



Buffetgestell BASIC
buffet stand BASIC

Induktion und Intuition.

Ein gekapselter Transtherm®-Boden mit Aluminiumkern, das intelligente Rücklaufsystem für Kondenswasser und ein umfangreiches Zubehör – WMF Chafing Dishes HOT & FRESH zeichnen sich durch ihre besondere Funktionalität und Flexibilität aus. Auf alle Produkte der WMF CHANGE Kollektion abgestimmt, lassen sie sich vielseitig kombinieren.

Induction and intuition.

An encapsulated Transtherm® base with aluminium core, the smart return system for condensation and an extensive choice of accessories – WMF HOT & FRESH chafing dishes are characterised by their superb functionality and versatility. Matched to all the products in the WMF CHANGE collection, they can be combined in lots of different ways.



High End Design made in Germany.

Hochwertige Bremsen sorgen dafür, dass der Lauf des Deckels optimal gedämpft wird. Er lässt sich spielend leicht öffnen, bleibt stufenlos stehen und ist ganz soft wieder verschließbar.

High-end design made in Germany.

High-quality brakes keep the movement of the lid optimally slow. The lid opens at a touch, stays open at any angle, and closes again softly to reseal perfectly.



Immer in passender Form.

Die WMF Chafing Dishes HOT & FRESH gibt es rund und rechteckig in GN 2/3- und GN 1/1-Größe, passend für Einsätze bis zehn Zentimeter Tiefe.

Always in great shape.

WMF HOT & FRESH chafing dishes are available round or rectangular in GN 2/3 and GN 1/1 size, compatible with inserts up to ten cm in depth.



Produktvarianten
Product variants



rund
round



GN 2/3
GN 2/3



GN 1/1
GN 1/1

Ausführungen CHANGE
CHANGE models



HOT & FRESH „BASIC“



HOT & FRESH „MANHATTAN“



HOT & FRESH „PALAST“
(Sonderausführung auf Anfrage.
Special design on request.)

Abbildung Chafing Dishes HOT & FRESH „BASIC“ auf Buffetgestell NEUTRAL.
Illustration HOT & FRESH 'BASIC' chafing dishes on NEUTRAL buffet stands.



**Chafing Dish, „Basic“, GN 1/1
HOT & FRESH**

Chafing Dish, „Basic“, GN 1/1
Chafing Dish, „Basic“, GN 1/1
Chafing Dish, „Basic“, GN 1/1
Chafing Dish, „Basic“, GN 1/1

passend für Einsätze bis Tiefe 10 cm, induktionsgeeignet, alternativ mit Heizplatte und Brennstoff beheizbar, Glasdeckel mit Bremse abnehmbar, Bügelgriff /
for inserts up to depth 10 cm / 4 in., inductive, electrically and sterno heating possible, glass lid with break removable, bow handle

Cromargan®, Glas / stainless 18/10, glass

Größe	size
cm	in.
58 x 47 x 19	22 3/4 x 18 1/2 x 7 1/2

55.0128.6040



**Chafing Dish, „Manhattan“, GN 1/1
HOT & FRESH**

Chafing Dish, „Manhattan“, GN 1/1
Chafing Dish, „Manhattan“, GN 1/1
Chafing Dish, „Manhattan“, GN 1/1
Chafing Dish, „Manhattan“, GN 1/1

passend für Einsätze bis Tiefe 10 cm, induktionsgeeignet, alternativ mit Heizplatte und Brennstoff beheizbar, Glasdeckel mit Bremse abnehmbar, Griff 4-Kantprofil (matt) /
for inserts up to depth 10 cm / 4 in., inductive, electrically and sterno heating possible, glass lid with break removable, bow handle, stainless steel polished, handle profile 4-cornered (satin finished)

Cromargan®, Glas / stainless 18/10, glass

Größe	size
cm	in.
58 x 47 x 19	22 3/4 x 18 1/2 x 7 1/2

55.0129.6040



**Chafing Dish, „Basic“, GN 2/3
HOT & FRESH**

Chafing Dish, „Basic“, GN 2/3
Chafing Dish, „Basic“, GN 2/3
Chafing Dish, „Basic“, GN 2/3
Chafing Dish, „Basic“, GN 2/3

passend für Einsätze bis Tiefe 10 cm, induktionsgeeignet, alternativ mit Heizplatte und Brennstoff beheizbar, Glasdeckel mit Bremse abnehmbar, Bügelgriff /
fitting for inserts up to depth 10 cm / 4 in., inductive, electrically and sterno heating possible, glass lid with brake removable, bow handle

Cromargan®, Glas / stainless 18/10, glass

Größe	size
cm	in.
37 x 45 x 19	14 1/2 x 17 3/4 x 7 1/2

55.0002.6040



**Chafing Dish, „Manhattan“, GN 2/3
HOT & FRESH**

Chafing Dish, „Manhattan“, GN 2/3
Chafing Dish, „Manhattan“, GN 2/3
Chafing Dish, „Manhattan“, GN 2/3
Chafing Dish, „Manhattan“, GN 2/3

passend für Einsätze bis Tiefe 10 cm, induktionsgeeignet, alternativ mit Heizplatte und Brennstoff beheizbar, Glasdeckel mit Bremse abnehmbar, Griff 4-Kantprofil (mattiert) / fitting for inserts up to depth 10 cm / 4 in., inductive, electrically and sterno heating possible, glass lid with brake removable, handle profile 4-cornered (satin finished)

Cromargan®, Glas / stainless 18/10, glass

Größe	size
cm	in.
37 x 45 x 19	14 1/2 x 17 3/4 x 7 1/2

55.0021.6040



**Chafing Dish, „Basic“, rund
HOT & FRESH**

Chafing Dish, „Basic“, round
Chafing Dish, „Basic“, rond
Chafing Dish, „Basic“, redondo
Chafing Dish, „Basic“, rotondo

passend für Einsätze bis Tiefe 10 cm, induktionsgeeignet, alternativ mit Heizplatte und Brennstoff beheizbar, Glasdeckel mit Bremse abnehmbar, Bügelgriff / fitting for inserts up to depth 10 cm / 4 in., inductive, electrically and sterno heating possible, glass lid with brake removable, bow handle

Cromargan®, Glas / stainless 18/10, glass

Höhe	height	Ø	Ø
cm	in.	cm	in.
19	7 1/2	39	15 1/4

55.0001.6040



**Chafing Dish, „Manhattan“, rund
HOT & FRESH**

Chafing Dish, „Manhattan“, round
Chafing Dish, „Manhattan“, rond
Chafing Dish, „Manhattan“, redondo
Chafing Dish, „Manhattan“, rotondo

passend für Einsätze bis Tiefe 10 cm, induktionsgeeignet, alternativ mit Heizplatte und Brennstoff beheizbar, Glasdeckel mit Bremse abnehmbar, Griff 4-Kantprofil (mattiert) / fitting for inserts up to depth 10 cm / 4 in., inductive, electrically and sterno heating possible, glass lid with brake removable, handle profile 4-cornered (satin finished)

Cromargan®, Glas / stainless 18/10, glass

Höhe	height	Ø	Ø
cm	in.	cm	in.
19	7 1/2	39	15 1/4

55.0020.6040



**Buffetgestell, GN 1/1
HOT & FRESH**

frame, GN 1/1
bati, GN 1/1
soporte buffet, GN 1/1
telaio, GN 1/1

für Heizplatte und Brennstoff, passend zu allen Chafing Dishes GN 1/1
HOT & FRESH /
for electrically and sterno heating, fitting for all chafing dishes GN 1/1
HOT & FRESH

Cromargan®, poliert / stainless 18/10, mirror finish

Größe	size
cm	in.
58 x 37 x 17	22 3/4 x 14 1/2 x 6 3/4

55.0137.6040

**Buffetgestell, „Basic“, GN 1/1
HOT & FRESH**

frame, „Basic“, GN 1/1
bati, „Basic“, GN 1/1
soporte buffet, „Basic“, GN 1/1
telaio, „Basic“, GN 1/1

für Heizplatte und Brennstoff, Füße Rundprofil /
for electrically and sterno heating, feet profile round

Cromargan®, poliert / stainless 18/10, mirror finish

Größe	size
cm	in.
65 x 37 x 24	25 1/2 x 14 1/2 x 9 1/2

55.0130.6040



**Buffetgestell, „Manhattan“, GN 1/1
HOT & FRESH**

frame, „Manhattan“, GN 1/1
bati, „Manhattan“, GN 1/1
soporte buffet, „Manhattan“, GN 1/1
telaio, „Manhattan“, GN 1/1

für Heizplatte und Brennstoff, Füße 4-Kantprofil (mattiert) /
for electrically and sterno heating, feet profile 4-cornered (satin
finished)

Cromargan®, poliert / stainless 18/10, mirror finish

Größe	size
cm	in.
66 x 37 x 24	26 1/2 x 14 1/2 x 9 1/2

55.0131.6040





Buffetgestell, GN 2/3

HOT & FRESH

frame, GN 2/3
 bati, GN 2/3
 soporte buffet, GN 2/3
 telaio, GN 2/3

für Heizplatte und Brennstoff, passend zu allen Chafing Dishes GN 2/3
 HOT & FRESH /

for electrically and sterno heating, fitting for all chafing dishes GN 2/3
 HOT & FRESH

Cromargan® / stainless 18/10

Größe	size
cm	in.
37 x 40 x 17	14 1/2 x 15 3/4 x 6 3/4

55.0006.6040



Buffetgestell, „Basic“, GN 2/3

HOT & FRESH

frame, „Basic“, GN 2/3
 bati, „Basic“, GN 2/3
 soporte buffet, „Basic“, GN 2/3
 telaio, „Basic“, GN 2/3

für Heizplatte und Brennstoff, Füße Rundprofil /
 for electrically and sterno heating, feet profile round

Cromargan® / stainless 18/10

Größe	size
cm	in.
44 x 40 x 24	17 1/4 x 15 3/4 x 9 1/2

55.0012.6040



Buffetgestell, „Manhattan“, GN 2/3

HOT & FRESH

frame, „Manhattan“, GN 2/3
 bati, „Manhattan“, GN 2/3
 soporte buffet, „Manhattan“, GN 2/3
 telaio, „Manhattan“, GN 2/3

für Heizplatte und Brennstoff, Füße 4-Kantprofil (mattiert) /
 for electrically and sterno heating, feet profile 4-cornered (satin
 finished)

Cromargan® / stainless 18/10

Größe	size
cm	in.
44 x 40 x 24	17 1/4 x 15 3/4 x 9 1/2

55.0013.6040

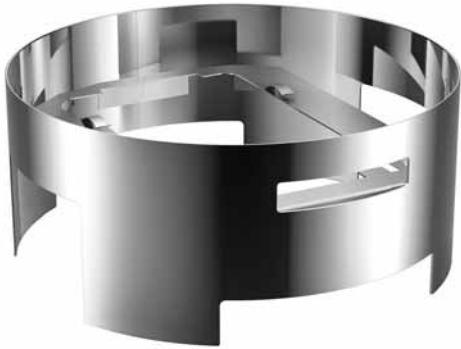

**Buffetgestell, rund
HOT & FRESH**

frame, round
bati, rond
soporte buffet, redondo
telaio, rotondo

für Heizplatte und Brennstoff, passend zu allen runden Chafing Dishes
HOT & FRESH /
for electrically and sterno heating, fitting for all round chafing dishes
HOT & FRESH

Cromargan® / stainless 18/10

Höhe	height	Ø	Ø
cm	in.	cm	in.
17	6 ³ / ₄	39	15 ¹ / ₄

55.0005.6040



**Buffetgestell, „Basic“, rund
HOT & FRESH**

frame, „Basic“, round
bati, „Basic“, rond
soporte buffet, „Basic“, redondo
telaio, „Basic“, rotondo

für Heizplatte und Brennstoff, Füße Rundprofil /
for electrically and sterno heating, feet profile round

Cromargan® / stainless 18/10

Höhe	height	Ø	Ø
cm	in.	cm	in.
24	9 ¹ / ₂	47	18 ¹ / ₂

55.0007.6040



**Buffetgestell, „Manhattan“, rund
HOT & FRESH**

frame, „Manhattan“, round
bati, „Manhattan“, rond
soporte buffet, „Manhattan“, redondo
telaio, „Manhattan“, rotondo

für Heizplatte und Brennstoff, Füße 4-Kantprofil (mattiert) /
for electrically and sterno heating, feet profile 4-cornered (satin
finished)

Cromargan® / stainless 18/10

Höhe	height	Ø	Ø
cm	in.	cm	in.
24	9 ¹ / ₂	47	18 ¹ / ₂

55.0008.6040

WMF CHANGE Chafing Dishes: Freie Hand am Buffet. Von allen Seiten.

WMF CHANGE chafing dishes:
One hand free at the buffet. From all sides.



Die WMF CHANGE Chafing Dishes gehen Hand in Hand mit einem reibungslosen Ablauf am Buffet, denn sie sind besonders einfach bedienbar, hygienisch und ganzheitlich durchdacht. Ihre Rolltop-Deckel lassen sich nahezu geräuschlos und leicht auf und zu schieben, so dass immer eine Hand für den Teller und die Speisen frei bleibt. Nichts muss umständlich abgestellt oder wieder zugedeckt werden. Das spart Zeit, Energie und hebt die Laune.

The WMF CHANGE chafing dishes go hand in hand with smooth proceedings at the buffet due to being outstandingly user-friendly, hygienic and well-designed. The roll-top lids slide open and closed almost soundlessly and with the easy action that leaves one hand free for plate and goodies. Nothing has to be awkwardly set down or covered over again. This helps save time and energy and lifts the mood.

Einfach und sorglos zu bedienen.

Kein Tropfen, keine Wasserrückstände auf dem Tisch, dafür hitzeisolierte Griffe. Und die Deckel der WMF CHANGE Chafing Dishes mit integriertem Kondenswasserrücklauf sind komplett versenkbar. Sie schwingen außerhalb des Drehpunktes um den Brennstoffdosenhalter oder die Heizplatte vollständig unter den Behälter. So sind die Speisen von allen Seiten zugänglich und die Belüftung der Flamme ist stets gewährleistet.

Handle without care.

No drips, no water marking the table; thermally insulated handles instead. And the lids of the WMF CHANGE chafing dishes with integral condensation return are fully retractable. They swing outside the pivot point round the fuel-can holder or the hotplate and pass completely underneath the containers. So the dishes are accessible from all sides and the flame is never choked for air.

Lässt sich mit Links öffnen.

Ergonomisch durchdacht garantiert eine spezielle Kabelführung auch beim Einsatz eines elektrischen Heizteiles, dass sich der Deckel problemlos öffnen lässt. Leichtgängige, stufenlose Bremsen sorgen dafür, dass der Lauf des Deckels optimal gedämpft wird. Für ein spielend einfaches Öffnen, Schließen und Arretieren. Alle Modelle, außer Manhattan, lassen sich platz sparend stapeln.

Opens at the lightest touch.

A model of ergonomics in practice, a special cable guide allows the lid to open easily even when an electric heating element is in use. Smooth-acting, stepless brakes keep the movement of the lid optimally slow. For totally convenient opening, closing and stopping. All models, except the Manhattan, are stackable to save space.

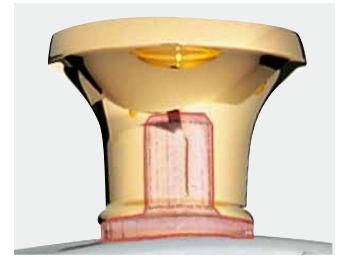

Produktvarianten
Product variants



GN 1/1
GN 1/1



rund
round

Ausführungen CHANGE
CHANGE models



„BASIC“



„MANHATTAN“



„METROPOLITAIN“

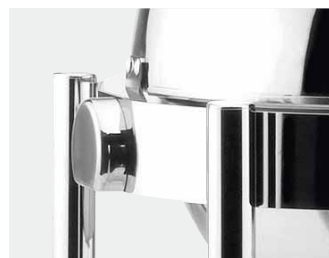



Chafing Dish, "Basic"

CHANGE

Chafing Dish, "Basic"
 Chafing Dish, "Basic"
 Chafing Dish, "Basic"
 Chafing Dish, "Basic"

passend für Einsätze bis Tiefe 10 cm /
 fitting for inserts up to depth 4 in.

GN 1/1, Rolltopdeckel, elektrisch und Brennstoff beheizbar, Deckel versenkbar /

GN 1/1, full rolltop cover, electrically and sterno heated, cover immersible

Cromargan®, Füße Rundprofil, Bügelgriffe /
 stainless 18/10, feet profil round, with bow handles
 ohne Einsätze / w/o inserts

Höhe cm	height in.	Größe mit Griffen cm	size with handles in.
45,6	18	74 x 38	28 1/4 x 15

06.3333.6041

Zubehör / accessory:

Heizelement/ heating element 230 V / 600 W

55.0097.6044

Heizelement/ heating element 120 V / 600 W

55.0097.9990

Heizelement mit Regler/

heating element adjustable 230 V / 700 W

06.3286.6046

Brennstoffdosenhalter / burner holder

06.3322.6039



Chafing Dish, "Metropolitan"

CHANGE

Chafing Dish, "Metropolitan"
 Chafing Dish, "Metropolitan"
 Chafing Dish, "Metropolitan"
 Chafing Dish, "Metropolitan"

passend für Einsätze bis Tiefe 10 cm /
 fitting for inserts up to depth 4 in.

GN 1/1, Rolltopdeckel, elektrisch und Brennstoff beheizbar, Deckel versenkbar /

GN 1/1, full rolltop cover, electrically and sterno heated, cover immersible

Cromargan®, Füße Rundprofil, Kugelgriffe /
 stainless 18/10, feet profil round, with knob handles
 ohne Einsätze / w/o inserts

Höhe cm	height in.	Größe mit Griffen cm	size with handles in.
45,6	18	74 x 38	28 1/4 x 15

06.3330.6041

Zubehör / accessory:

Heizelement/ heating element 230 V / 600 W

55.0097.6044

Heizelement/ heating element 120 V / 600 W

55.0097.9990

Heizelement mit Regler/

heating element adjustable 230 V / 700 W

06.3286.6046

Brennstoffdosenhalter / burner holder

06.3322.6039

Bitte Heizelement und Brennstoffdosenhalter separat bestellen. Einzelteile (Seite 231) /
 Please order heating elements and burner holder separately. Spare parts (page 231)



Chafing Dish, "Metropolitan", rund CHANGE

Chafing Dish, "Metropolitan", round
Chafing Dish, "Metropolitan", rond
Chafing Dish, "Metropolitan", redondo
Chafing Dish, "Metropolitan", rotondo

passend für Einsätze bis Tiefe 10 cm /
fitting for inserts up to depth 4 in.

rund, Rolltopdeckel, elektrisch und Brennstoff beheizbar, Deckel
versenkbar /
round, full rolltop cover, electrically and sterno heated, cover
immersible

Cromargan®, Füße Rundprofil, Kugelgriff /
stainless 18/10, feet profil round, with knob handle

Höhe	height	Ø	Ø
cm	in.	cm	in.
46	18	43	17

06.3940.6041

Zubehör / accessory:

Heizelement/ heating element 140-250 V / 270 W 55.0096.6044

Heizelement/ heating element 100-120 V / 230 W 55.0096.9990

Heizelement mit Regler/

heating element adjustable 230 V / 550 W 06.2095.6046

Brennstoffdosenhalter / burner holder 06.3940.6039



Chafing Dish, "Manhattan" CHANGE

Chafing Dish, "Manhattan"
Chafing Dish, "Manhattan"
Chafing Dish, "Manhattan"
Chafing Dish, "Manhattan"

passend für Einsätze bis Tiefe 10 cm /
fitting for inserts up to depth 4 in.

GN 1/1, Rolltopdeckel, elektrisch und Brennstoff beheizbar, Deckel
versenkbar /

GN 1/1, full rolltop cover, electrically and sterno heated, cover
immersible

Cromargan®, teilmattiert, Füße und Griffe im 4-Kantprofil /
stainless 18/10, partly satin finished, handles and feet profil 4-cornered
ohne Einsätze / w/o inserts

Höhe	height	Größe mit Griffen	size with handles
cm	in.	cm	in.
45,6	18	74 x 38	28 1/4 x 15

06.3335.6041

Zubehör / accessory:

Heizelement/ heating element 230 V / 600 W 55.0097.6044

Heizelement/ heating element 120 V / 600 W 55.0097.9990

Heizelement mit Regler/

heating element adjustable 230 V / 700 W 06.3286.6046

Brennstoffdosenhalter / burner holder 06.3322.6039



**Chafing Dish, "Manhattan", rund
CHANGE**

Chafing Dish, "Manhattan", round
Chafing Dish, "Manhattan", rond
Chafing Dish, "Manhattan", redondo
Chafing Dish, "Manhattan", rotondo

passend für Einsätze bis Tiefe 10 cm /
fitting for inserts up to depth 4 in.

rund, Rolltopdeckel, elektrisch und Brennstoff beheizbar, Deckel
versenkbar /
round, full rolltop cover, electrically and sterno heated, cover
immersible

Cromargan®, teilmattiert, Füße und Griff im 4-Kantprofil /
stainless 18/10, partly satin finished, handle and feet profil 4-cornered

Höhe	height	Ø	Ø	
cm	in.	cm	in.	
46	18	43	17	06.3945.6041

Zubehör / accessory:

Heizelement/ heating element 140-250 V / 270 W	55.0096.6044
Heizelement/ heating element 100-120 V / 230 W	55.0096.9990
Heizelement mit Regler/ heating element adjustable 230 V / 550 W	06.2095.6046
Brennstoffdosenhalter / burner holder	06.3940.6039



Breite Aufliegerahmen: 35,5 mm
width supporting frame: 1 3/8 in.



Chafing Dish „Metropolitan“, Thekeneinbau

Chafing Dish, to be built into counter
Chafing Dish, pour montage en comptoir
Chafing Dish, encastrado
Chafing Dish, emportable

passend für Einsätze bis Tiefe 10 cm /
fitting for inserts up to depth 4 in.

GN 1/1, Rolltopdeckel, elektrisch beheizbar /
GN 1/1, full rolltop cover, electrically heated

Cromargan® / stainless 18/10
ohne Einsätze / w/o inserts

Höhe	height	Größe	size	
cm	in.	cm	in.	
17	6 3/4	65 x 47	25 5/8 x 18 1/2	06.3266.6041

Zubehör / accessory:

Heizelement/ heating element 230 V / 600 W	55.0097.6044
Heizelement/ heating element 120 V / 600 W	55.0097.9990
Heizelement mit Regler/ heating element adjustable 230 V / 700 W	06.3286.6046

Ausschnittmaße / cut out size

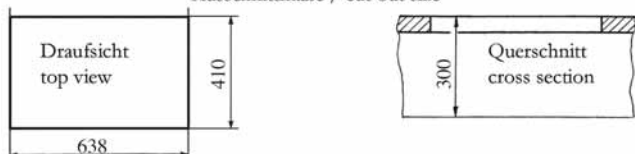

Bitte Heizelement und Brennstoffdosenhalter separat bestellen. Einzelteile (Seite 231) /
Please order heating elements and burner holder separately. Spare parts (page 231)



Portions-Chafing Dish „Metropolitan“

Chafing Dish, S
Chafing Dish, S
Chafing Dish, S
Chafing Dish, S

passend für alle handelsüblichen Porzellanteller mit \varnothing 23 cm, beheizbar mit Teelichte (nicht enthalten) / suitable for all porcelain plates \varnothing 9 in., heated by tealights (not included)

rund, Rolltopdeckel, mit 2 Teelichten beheizbar / round, full rolltop cover, heated by 2 tealights

Cromargan® / stainless 18/10
ohne Einsätze / w/o inserts

Höhe	height	\varnothing	\varnothing
cm	in.	cm	in.
29	11 $\frac{1}{2}$	26	10 $\frac{1}{4}$

06.3306.6040



Breite Aufliegerahmen: 40 mm
width supporting frame: 1 $\frac{1}{2}$ in.



Chafing Dish „Metropolitan“, Thekeneinbau

Chafing Dish, to be built into counter
Chafing Dish, pour montage en comptoir
Chafing Dish, encastrado
Chafing Dish, emportable

passend für Einsätze bis Tiefe 10 cm / fitting for inserts up to depth 4 in.

rund, Rolltopdeckel, elektrisch beheizbar / round, full rolltop cover, electrically heated

Cromargan® / stainless 18/10
ohne Heizelement, ohne Einsätze / w/o heating element, w/o inserts

Höhe	height	\varnothing	\varnothing
cm	in.	cm	in.
18,3	7 $\frac{1}{4}$	48	18 $\frac{7}{8}$

06.3290.6041

Zubehör / accessory:

Heizelement/ heating element 140-250 V / 270 W

55.0096.6044

Heizelement/ heating element 100-120 V / 230 W

55.0096.9990

Heizelement mit Regler/

heating element adjustable 230 V / 550 W

06.2095.6046

Draufsicht / top view

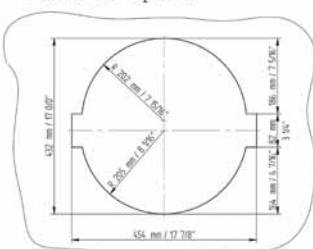

Ausschnittmaße / cut out size

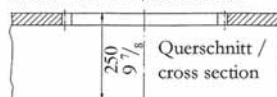



Chafing Dish, mit Domdeckel

ECONOMY

Chafing Dish, conventional standard cover
 Chafing Dish, avec couvercle standard
 Chafing Dish, tapa estándar
 Chafing Dish, con coperchio standard

passend für Einsätze bis Tiefe 10 cm, Deckel zu allen 4 Seiten
 hochstellbar /

fitting for inserts up to depth 4 in., lid can be raised on all 4 sides

GN 1/1, stapelbar, Domdeckel, elektrisch und Brennstoff beheizbar /
 GN 1/1, stackable, conventional standard cover, electrically and sterno
 heated

Cromargan® matt / stainless 18/10 satin finished
 ohne Einsätze / w/o inserts

Höhe mit Griff	height with handle	Größe mit Griffen	size with handles	
cm	in.	cm	in.	
32	12 1/2	62 x 35	24 1/2 x 13 3/4	06.3322.6230

Zubehör / accessory:

Heizelement/ heating element 230 V / 600 W	55.0097.6044
Heizelement/ heating element 120 V / 600 W	55.0097.9990
Heizelement mit Regler/	
heating element adjustable 230 V / 700 W	06.3286.6046
Brennstoffdosenhalter / burner holder	06.3322.6039
Heizelement/ heating element 230 V / 1000 W	06.2082.6044
Adapter für Elektroheizteil /	
holder for heating element	06.3272.6039

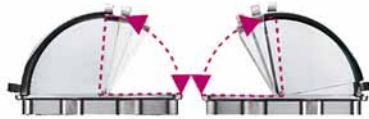

Chafing Dish, mit Klappdeckel

ECONOMY

Chafing Dish, 1/2 rolltop cover
 Chafing Dish, avec couvercle rabattable
 Chafing Dish, con tapa abatible
 Chafing Dish, con coperchio ribaltabile

passend für Einsätze bis Tiefe 10 cm /
 fitting for inserts up to depth 4 in.

GN 1/1, Klappdeckel, elektrisch und Brennstoff beheizbar /
 GN 1/1, cover, electrically and sterno heated

Cromargan® matt / stainless 18/10 satin finished
 ohne Einsätze / w/o inserts

Höhe mit Griff	height with handle	Größe mit Griffen	size with handles	
cm	in.	cm	in.	
36	14 1/4	62 x 35	24 1/2 x 13 3/4	06.3324.6230

Zubehör / accessory:

Heizelement/ heating element 230 V / 600 W	55.0097.6044
Heizelement/ heating element 120 V / 600 W	55.0097.9990
Heizelement mit Regler/	
heating element adjustable 230 V / 700 W	06.3286.6046
Brennstoffdosenhalter / burner holder	06.3322.6039
Heizelement/ heating element 230 V / 1000 W	06.2082.6044
Adapter für Elektroheizteil /	
holder for heating element	06.3272.6039



Bitte Heizelement und Brennstoffdosenhalter separat bestellen. Einzelteile (Seite 231) /
 Please order heating elements and burner holder separately. Spare parts (page 231)

Ersatzteile für WMF Chafing Dishes
Spare parts for WMF Chafing Dishes

Bezeichnung Designation	Artikel-Nummer Order no.	Ausführung execution	Cromargan Stainless 18/10	Teilvergoldet partly gold plated	Deckel cover	Wasserbad- wanne water pan	Einbaurahmen frame	Brennstoffhalter burner holder	Heizelement heating element	Heizelement mit Regler heating element adjustable
Thekeneinbau GN 1/1	06.3266.6040	bis/ till 2015	•		06.3330.6042	06.3319.6231	06.3266.6045		55.0097.6044	06.3286.6046
Thekeneinbau GN 1/1	06.3266.6041	Neue Bremse/ New Brakes 2015	•		06.3330.6043		06.3266.6046			
Thekeneinbau, rund	06.3290.6040	bis/ till 2015	•		06.3283.6042	06.2003.6041	06.3290.6045		55.0096.6044	06.2095.6046
Thekeneinbau, rund	06.3290.6041	Neue Bremse/ New Brakes 2015	•		06.3940.6043		06.3290.6046			
Economy GN 1/1	06.3322.6230		•		06.3322.6232	06.3322.6231		06.3322.6039	55.0097.6044	06.3286.6046
Economy GN 1/1	06.3324.6230		•		06.3324.6232			06.3322.6039	55.0097.6044	06.3286.6046
Metropolitan GN 1/1	06.3330.6040	bis/ till 2015	•		06.3330.6042			06.3322.6039	55.0097.6044	06.3286.6046
Metropolitan GN 1/1	06.3330.6041	Neue Bremse/ New Brakes 2015	•		06.3330.6043					
Palast GN 1/1	06.3331.6210	bis/ till 2015		•	06.3331.6212 Auf Anfrage / on request					
Palast GN 1/1	Sonderausführung / special design Auf Anfrage / on request	Neue Bremse/ New Brakes 2015		•	Sonderausführung / special design Auf Anfrage / on request	06.3319.6231		06.3322.6039	55.0097.6044	06.3286.6046
Basic GN 1/1	06.3333.6040	bis/ till 2015	•		06.3333.6042			06.3322.6039	55.0097.6044	06.3286.6046
Basic GN 1/1	06.3333.6041	Neue Bremse/ New Brakes 2015	•		06.3333.6043					
Manhattan GN 1/1	06.3335.6040	bis/ till 2015	•		06.3335.6042				55.0097.6044	06.3286.6046
Manhattan GN 1/1	06.3335.6041	Neue Bremse/ New Brakes 2015	•		06.3335.6043			06.3322.6039	55.0097.6044	06.3286.6046
Metropolitan rund	06.3940.6040	bis/ till 2015	•		06.3940.6042			06.3940.6039	55.0096.6044	06.2095.6046
Metropolitan rund	06.3940.6041	Neue Bremse/ New Brakes 2015	•		06.3940.6043	06.2003.6041				
Palast rund	06.3941.6210	bis/ till 2015		•	06.3941.6212 Auf Anfrage / on request					
Palast rund	Sonderausführung / special design Auf Anfrage / on request	Neue Bremse/ New Brakes 2015		•	Sonderausführung / special design Auf Anfrage / on request	06.2003.6041		06.3940.6039	55.0096.6044	06.2095.6046
Manhattan rund	06.3945.6040	bis/ till 2015	•		06.3945.6042			06.3940.6039	55.0096.6044	06.2095.6046
Manhattan rund	06.3945.6041	Neue Bremse/ New Brakes 2015	•		06.3945.6043					
combiNation Buffet GN 1/1	06.2446.6040		•		06.2446.6042	06.3322.6231			55.0097.6044	06.3286.6046
combiNation Buffet GN 1/1	06.2423.6040		•			06.3322.6231			55.0097.6044	06.3286.6046
combiNation Buffet GN 1/1	06.2442.6040		•			06.3322.6231				

Bitte bestellen Sie die Heizelemente und Brennstoffhalter separat (s. Katalog Chafing Dish-Zubehör) Please order the heating elements and the burner holder separately. (see catalogue Chafing Dish-Accessory)



Suppenmarmite

soup tureen
marmite à potage
recipiente sopa
zuppiera

passend in Chafing Dish GN 1/1 und HOT & FRESH GN 2/3 /
fitting for chafing dish GN 1/1 and HOT & FRESH GN 2/3

Cromargan® / stainless 18/10

Größe	size	Inhalt	cap.
cm	in.	Ltr.	oz.
36 x 33	14 1/4 x 13	4,5	157,5

Topf f. Aufliegedeckel / pot f. normal lid	06.2007.6041
Aufliegedeckel / normal lid	06.2098.6042
Topf f. Scharnierdeckel / pot f. hinged lid	06.2007.9991
Scharnierdeckel / hinged lid	06.2007.9992
Einsatzring / ring	06.3301.6044

* Artikel einzeln bestellen / please order articles separately



Suppenmarmite

soup tureen
marmite à potage
recipiente sopa
zuppiera

passend in Chafing Dish GN 1/1 und HOT & FRESH GN 2/3 /
fitting for chafing dish GN 1/1 and HOT & FRESH GN 2/3

Cromargan® / stainless 18/10

Größe	size	Inhalt	cap.
cm	in.	Ltr.	oz.
36 x 33	14 1/4 x 13	9	315

Topf mit Deckel / pot with cover	06.3297.6040
Einsatzring / ring	06.2094.6044

* Artikel einzeln bestellen / please order articles separately



Suppenstation, GN 1/1 mit Deckel

soup tureen, GN 1/1 with lid
marmite à potage, GN 1/1 avec couvercle
recipiente sopa, GN 1/1 con tapa
zuppiera, GN 1/1 con coperchio

passend in Chafing Dish GN 1/1 /
fitting for chafing dish GN 1/1

Größe	size	Inhalt	cap.
cm	in.	Ltr.	oz.
53 x 32,5	20 ³ / ₄ x 12 ³ / ₄	2 x 4,5	2 x 157,5

Ausführung I /quality I

Cromargan® / stainless 18/10
1 Abdeckplatte, 2 Suppentöpfe mit Scharnierdeckel / 1 insert
plate and 2 soup tureens with hinged lid
Komplett / complete

06.2007.9990

Ausführung II /quality II

Cromargan® / stainless 18/10
1 Abdeckplatte und 2 Suppentöpfe mit Deckel / 1 insert plate
and 2 soup tureens with lid
Komplett / complete

06.2007.6040

Ersatzteil / spare part:

Topf f. Scharnierdeckel / pot f. hinged lid

06.2007.9991

Topf f. Aufliegedeckel / pot f. normal lid

06.2007.6041

Scharnierdeckel / hinged lid

06.2007.9992

Aufliegedeckel / normal lid

06.2098.6042

Brille / insert holder

06.2098.6044



Suppenmarmite

soup tureen
marmite à potage
sopera para chafing dish
zuppiera per chafing dish

passend in alle großen runden WMF Chafing Dishes und in den Chafing
Dish HOT & FRESH rund. In 2 Versionen bestellbar: Ring + Topf f.
Aufliegedeckel + Aufliegedeckel / Ring + Topf für Scharnierdeckel +
Scharnierdeckel. /

fitting in all big round WMF chafing dishes and in Chafing Dish
HOT & FRESH round. To be ordered in 2 versions: ring + pot f. normal lid +
cover / ring + pot f. hinged lid + hinged cover.

Cromargan® / stainless 18/10

Inhalt	cap.	Ø	Ø
Ltr.	oz.	cm	in.
4,5	157,5	34	13 ¹ / ₂

Ring / ring

55.0068.6040

Topf f. Aufliegedeckel / pot f. normal lid

06.2007.6041

Aufliegedeckel / normal lid

06.2098.6042

Topf f. Scharnierdeckel / pot f. hinged lid

06.2007.9991

Scharnierdeckel / hinged lid

06.2007.9992

* Artikel einzeln bestellen / please order articles separately



Suppenmarmite

soup tureen
marmite à potage
sopera para chafing dish
zuppiera per chafing dish

passend in alle großen runden Chafing Dishes von WMF und den Chafing Dish HOT & FRESH rund / fitting for all big round WMF chafing dishes and in chafing dish HOT & FRESH round

Cromargan® / stainless 18/10

Inhalt	cap.	Ø	Ø
Ltr.	oz.	cm	in.
9	315	34	13 1/2

Topf mit Deckel / pot with cover

06.3297.6040

Ring / ring

06.2087.6044

* Artikel einzeln bestellen / please order articles separately



Porzellan-Einsatz, geteilt

porcelain insert, divided
intérieur en porcelaine, divisé
recipiente de porcelana, dividido
interno in porcellana, ripartito

passend in alle großen runden Chafing Dishes von WMF / fitting for all big round WMF chafing dishes

Porzellan / porcelain

Höhe	height	Inhalt	cap.	Ø	Ø
cm	in.	Ltr.	oz.	cm	in.
7	2 3/4	2 x 1,75	2 x 62	33,5	13 1/4

60.3073.9990



Porzellan-Einsatz

porcelain insert
intérieur en porcelaine
interior porcelana
interno in porcellana

passend in alle großen runden Chafing Dishes von WMF / fitting for all big round WMF chafing dishes

Porzellan / porcelain

Höhe	height	Inhalt	cap.	Ø	Ø
cm	in.	Ltr.	oz.	cm	in.
7	2 3/4	3,75	131,3	33,5	13 1/4

60.3072.9990



Porzellan-Einsätze

porcelain insert
 intérieur en porcelaine
 interior de porcelana
 interno in porcellana

Porzellan weiß / porcelain white

Inhalt	cap.	Ø	Ø
Ltr.	oz.	cm	in.
1,5	52,5	20	8

60.3004.0690



Einsatz für Chafing Dish

insert for chafing dish
 intérieur pour chafing dish
 depósito para chafing dish
 inserto piatto chafing dish

passend in alle großen runden Chafing Dishes von WMF /
 fitting for all big round WMF chafing dishes

Cromargan® / stainless 18/10

Höhe	height	Inhalt	cap.	Ø	Ø
cm	in.	Ltr.	oz.	cm	in.
8	3 1/4	5	175	33,4	13 1/4
10,5	4 1/4	6,5	227,5	33,4	13 1/4

06.2083.6034

06.2083.6033



Platte, rund

platter, round
 plat, rond
 fuente, redonda
 vassoio, rotondo

passend in alle WMF Portions-Chafing Dishes /
 fitting for all WMF chafing dishes small size

Cromargan® / stainless 18/10

Ø	Ø
cm	in.
23	9

06.3306.6044





Porzellan-Einsatz, zu Chafing Dish

GN porcelain insert, for chafing dish
 GN intérieur, pour chafing dish
 GN interior porcelana, para chafing dish
 GN interno in porcellana, per chafing dish

Beachten: Gastronorm-Einsätze passen **nicht** in die Eiswanne von combiNation buffet! /
 GN inserts do **not** fit in the ice tray of combiNation buffet!

Porzellan / porcelain

Porzellaneinsatz GN ³/₆ / porcelain insert GN ³/₆

Größe cm	size in.	Inhalt Ltr.	cap. oz.	Höhe cm	height in.	
35,4 / 17,4 x 32,5 / 16,2	14 (7) x 12 ³ / ₄	0,7	24,5	2	³ / ₄	55.0219.9800
	(6 ¹ / ₃)					
35,4 / 17,4 x 32,5 / 16,2	14 (7) x 12 ³ / ₄	2,5	87,5	6,5	2 ¹ / ₂	55.0220.9800
	(6 ¹ / ₃)					

Porzellaneinsatz GN ¹/₆ / porcelain insert GN ¹/₆

Größe cm	size in.	Inhalt Ltr.	cap. oz.	Höhe cm	height in.	
16,2 x 17,5	6 ¹ / ₃ x 7	0,86	29,1	6,5	2 ¹ / ₂	55.0222.9800

Porzellaneinsatz GN ¹/₄ / porcelain insert GN ¹/₄

Größe cm	size in.	Inhalt Ltr.	cap. oz.	Höhe cm	height in.	
26,5 x 16,2	10 ¹ / ₂ x 6 ² / ₃	1,2	40,6	6,5	2 ¹ / ₂	55.0226.9800

Einsatz GN ¹/₃ / insert GN ¹/₃

Größe cm	size in.	Inhalt Ltr.	cap. oz.	
2 x 17,5 x 32,5	³ / ₄ x 7 x 12 ³ / ₄	0,4	14	60.3055.9990
6,5 x 17,5 x 32,5	2 ¹ / ₂ x 7 x 12 ³ / ₄	1,9	64,2	60.3047.9990

Einsatz GN ¹/₂ / insert GN ¹/₂

Größe cm	size in.	Inhalt Ltr.	cap. oz.	
2 x 26,5 x 32,5	³ / ₄ x 10 ¹ / ₂ x 12 ³ / ₄	0,7	24,5	60.3054.9990
6,5 x 26,5 x 32,5	2 ¹ / ₂ x 10 ¹ / ₂ x 12 ³ / ₄	3,3	111,54	60.3045.9990

Einsatz GN ²/₃ / insert GN ²/₃

Größe cm	size in.	Inhalt Ltr.	cap. oz.	
2 x 35,4 x 32,5	³ / ₄ x 14 x 12 ³ / ₄	0,8	28	60.3056.9990
6,5 x 35,4 x 32,5	2 ¹ / ₂ x 14 x 12 ³ / ₄	4,65	157,17	60.3046.9990

Einsatz GN ¹/₁ / insert GN ¹/₁

Größe cm	size in.	Inhalt Ltr.	cap. oz.	
2 x 53 x 32,5	³ / ₄ x 20 ³ / ₄ x 12 ³ / ₄	1,4	49	60.3053.9990
6,5 x 53 x 32,5	2 ¹ / ₂ x 20 ³ / ₄ x 12 ³ / ₄	7,3	246,74	60.3044.9990

Einsatz GN ²/₄ / insert GN ²/₄

Größe cm	size in.	Inhalt Ltr.	cap. oz.	
2 x 16 x 53	³ / ₄ x 6 ¹ / ₄ x 20 ³ / ₄	0,7	24,5	60.3057.9990
6,5 x 16 x 53	2 ¹ / ₂ x 6 ¹ / ₄ x 20 ³ / ₄	2,5	87,5	60.3048.9990

Gastronorm-Einsatz, zu Chafing Dish

GN insert, for chafing dish

GN intérieur, pour chafing dish

GN interior, para chafing dish

GN interno, per chafing dish

Beachten: Gastronorm-Einsätze passen **nicht** in die Eiswanne von combiNation buffet, sondern nur in mittlere und hohe Rahmen! / GN inserts do **not** fit in the ice tray of combiNation buffet, but only fit in frames medium and high!

Edelstahl 18/10 / stainless 18/10



Einsatz GN $\frac{1}{3}$ / insert GN $\frac{1}{3}$

Größe cm	size in.	Inhalt Ltr.	cap. oz.	
6,5 x 17,5 x 32,5	2 $\frac{1}{2}$ x 7 x 12 $\frac{3}{4}$	2,4	84	19.9955.0577
10 x 17,5 x 32,5	4 x 7 x 12 $\frac{3}{4}$	3,75	133	19.9955.0578

Einsatz GN $\frac{1}{2}$ / insert GN $\frac{1}{2}$

Größe cm	size in.	Inhalt Ltr.	cap. oz.	
6,5 x 26 x 32,5	2 $\frac{1}{2}$ x 10 $\frac{1}{4}$ x 12 $\frac{3}{4}$	3,8	133	19.9955.0581
10 x 26 x 32,5	4 x 10 $\frac{1}{4}$ x 12 $\frac{3}{4}$	6	210	19.9955.0582

Einsatz GN $\frac{2}{3}$ / insert GN $\frac{2}{3}$

Größe cm	size in.	Inhalt Ltr.	cap. oz.	
6,5 x 35,4 x 32,5	2 $\frac{1}{2}$ x 14 x 12 $\frac{3}{4}$	5,5	192,5	19.9955.0585
10 x 35,4 x 32,5	4 x 14 x 12 $\frac{3}{4}$	8,5	297,5	19.9955.0586



Einsatz GN $\frac{1}{1}$ / insert GN $\frac{1}{1}$

Größe cm	size in.	Inhalt Ltr.	cap. oz.	
6,5 x 53 x 32,5	2 $\frac{1}{2}$ x 20 $\frac{3}{4}$ x 12 $\frac{3}{4}$	8,5	297,5	19.9955.0589
10 x 53 x 32,5	4 x 20 $\frac{3}{4}$ x 12 $\frac{3}{4}$	13,3	465,5	19.9955.0590





Heizelement

heating element
 plaque électrique
 placa calentadora
 piastra riscaldante

für WMF Chafing Dishes GN 1/1 ohne Rolltop-Deckel /
 suitable for all WMF chafing dishes GN 1/1 without full rolltop cover

Größe	size
cm	in.
24 x 24	9 1/2 x 9 1/2

Heizelement/ heating element 230 V / 1000 W

06.2082.6044



Adapter für Elektroheizteil

holder for heating element
 adaptateur pour plaque électrique
 adaptador para placa calentadora
 adattatore per piastra riscaldante

zum problemlosen Einsatz von Heizelement 06.2082.6044 und
 06.2082.9990 für WMF Chafing Dishes GN 1/1 ohne Rolltop-Deckel /
 suitable for easy use of heating element 06.2082.6044 and
 06.2082.9990 for all WMF chafing dishes GN 1/1 without full rolltop
 cover

Cromargan® / stainless 18/10

Größe	size	Höhe	height
cm	in.	cm	in.
25 x 20	9 3/4 x 7 3/4	7	2 3/4

06.3272.6039



Heizelement

heating element
 plaque électrique
 placa calentadora
 piastra riscaldante

für alle großen runden WMF Chafing Dishes, VDE geprüft /
 suitable for all big round WMF chafing dishes, VDE proved

Größe	size
cm	in.
20 x 20	7 3/4 x 7 3/4

Heizelement/ heating element 140-250 V / 270 W

55.0096.6044

Heizelement/ heating element 100-120 V / 230 W

55.0096.9990

Heizelement mit Regler/
 heating element adjustable 230 V / 550 W

06.2095.6046



Heizelement

heating element
 plaque électrique
 place calentadora
 piastra riscaldante

für WMF Chafing Dishes HOT & FRESH GN 2/3 und rund /
 suitable for WMF chafing dishes HOT & FRESH GN 2/3 and round

Größe	size
cm	in.
25 x 20	9 3/4 x 7 3/4

Heizelement/ heating element 140-250 V / 220 W

55.0095.6044

Heizelement / heating element 120 V / 220 W

55.0135.9990



Heizelement

heating element
 plaque électrique
 placa calentadora
 piastra riscaldante

für WMF Chafing Dishes GN 1/1 und HOT & FRESH GN 1/1, VDE geprüft /
 suitable for WMF chafing dishes GN 1/1 and HOT & FRESH GN 1/1, VDE proved

Größe	size
cm	in.
25 x 20	9 3/4 x 7 3/4

Heizelement/ heating element 230 V / 600 W	55.0097.6044
Heizelement/ heating element 120 V / 600 W	55.0097.9990
Heizelement mit Regler/ heating element adjustable 230 V / 700 W	06.3286.6046
Heizelement mit Regler/ heating element adjustable 120 V / 700 W	55.0136.9990



Brennstoffdosenhalter

burner holder
 porte brûleur
 soporte quemador
 fornello

zur problemlosen Umstellung von elektrischer Heizung auf Brennstoff.
 Passend für alle WMF Chafing Dishes GN 1/1 und HOT & FRESH /
 for uncomplicated conversion from electrical to burner heating. Fitting
 for all WMF chafing dishes GN 1/1 and HOT & FRESH

Cromargan® / stainless 18/10

Größe	size
cm	in.
20 x 26 x 8,2	8 x 10 1/4 x 3 1/4

06.3322.6039



Brennstoffdosenhalter

burner holder
 porte brûleur
 soporte quemador
 fornello

zur problemlosen Umstellung von elektrischer Heizung auf Brennstoff.
 Passend für alle runden Chafing Dishes CHANGE /
 for uncomplicated conversion from electrical to burner heating. Fitting
 for all round WMF chafing dishes CHANGE

Cromargan® / stainless 18/10

Größe	size	Höhe	height
cm	in.	cm	in.
12,5 x 20	5 x 8	8,5	3 1/4

06.3940.6039



Brennstoffdose

fuel gel cartidge
 boîtes de gel combustible
 depósito de combustible
 lattine di gel carburante

Großpackung 36 St. /
 large package 36 pcs.

Inhalt	cap.
Ltr.	oz.
je Dose 0,2	each tin 7

60.3002.0690



Besteckablage

rack for utensils
support couverts à servir
soporte cubiertos servir
porta posante

zum Einhängen in die Rahmen aller GN 1/1 Chafing Dishes CHANGE und HOT & FRESH, kann auch ohne Chafing Dish freistehend verwendet werden. /

to hinge in the frames of all GN 1/1 chafing dishes CHANGE and HOT & FRESH, can also be used on its own without Chafing Dish.

Cromargan®, Porzellan weiß / stainless 18/10, porcelain white

Tablett/Besteckhalter / tray/cutlery holder

Größe	size	
cm	in.	
27,9 x 12 x 7,1	11 x 4 ³ / ₄ x 2 ³ / ₄	06.3539.6040

Porzellanschale / porcelain bowl

Größe	size	
cm	in.	
21 x 8,7 x 3,25	8 ¹ / ₄ x 3 ¹ / ₂ x 1 ¹ / ₄	60.3540.9990

* Artikel einzeln bestellen / please order articles separately

Besteckablage

rack for utensils
support couverts à servir
soporte cubiertos servir
porta posante

passend in alle WMF Chafing Dishes GN 1/1 in Standard- und Economy-Ausführung / fitting for all WMF chafing dishes GN 1/1 design Standard and Economy

Cromargan® / stainless 18/10

Größe	size	
cm	in.	
30 x 9	12 x 3 ¹ / ₂	06.3296.6030



Zwischensteg Induktion

connecting shelf
traverse
pasarela
ponticello

passend zu Chafing Dish HOT & FRESH / fitting with Chafing Dish HOT & FRESH

Cromargan® / stainless 18/10

55.0082.6040



Chafing Dish – Besteck

chafing dish serving set
 service pour chafing dish
 cubiertos para chafing dish
 posate chafing dish

Cromargan® / stainless 18/10

Chafing Dish Gabel / chafing dish fork

Länge	length
cm	in.
26	10 ¹ / ₄

12.8386.6042



Chafing Dish Löffel / chafing dish spoon

Länge	length
cm	in.
26	10 ¹ / ₄

12.8386.6041



Chafing Dish Gabel / chafing dish fork

Länge	length
cm	in.
26	10 ¹ / ₄

12.8249.6040



Salatgabel / salad fork

Länge	length
cm	in.
26	10 ¹ / ₄

12.8343.6042



Chafing Dish Gabel / chafing dish fork

Länge	length
cm	in.
32,5	12 ³ / ₄

12.8381.6042



Chafing Dish Löffel / chafing dish spoon

Länge	length
cm	in.
32,5	12 ³ / ₄

12.8381.6041



Fleischgabel / serving fork

Länge	length
cm	in.
32,5	12 ³ / ₄

12.8382.6040



Nudellöffel / pasta serving spoon

Länge	length
cm	in.
31,5	12 ¹ / ₂

12.8383.6040



Chafing Dish Gabel / chafing dish fork

Länge	length
cm	in.
39	15 ¹ / ₄

12.8387.6042



Chafing Dish Löffel / chafing dish spoon

Länge	length
cm	in.
39	15 ¹ / ₄

12.8387.6041

