

buffet | tabletop | bar

GASTRONOMIE- UND SERVIERARTIKEL

FOOD SERVICE EQUIPMENT
EQUIPAMIENTOS PROFESIONALES
EQUIPEMENT PROFESSIONNEL



2020

SINCE 1933

„Enjoy the new APS catalogue 2020!“

APS - Mehrwert
Inspiration & Service

APS - your added value
inspiration and service

APS - su beneficio adicional
inspiración y servicio

APS - votre bénéfice supplémentaire
inspiration et service



Reinhold Pott
managing director

Johannes Becker
managing director

family-run company
since 1933

Als inhabergeführtes Unternehmen in der 4. Generation legt APS viel Wert auf Kontinuität, Innovation und Vertrauen.

As a family-run company in the 4th generation, we value continuity, innovation and trust

Como empresa familiar administrada por la 4ª generación ponemos mucho énfasis en la continuidad, la innovación y la confianza.

En tant qu'entreprise familiale gérée par la 4ème génération, nous partageons nos valeurs en termes de continuité, d'innovation et de confiance.

APS Germany



APS head office | Sundern Germany



APS production | stainless steel trays | Made in Germany



Assheuer + Pott GmbH & Co. KG

Talweg 11 | 59846 Sundern
Germany

Phone: +49 (0) 29 33 / 97 35 - 0

E-Mail: info@aps-germany.de

aps-germany.de

buffet | tabletop | bar



Keep in touch
[aps_germany](https://www.instagram.com/aps_germany)



Visit our
website!



GGKA
Bestpartner
2018|2019

servicing ware & kitchen tools



S. 23



S.87



S.109

Buffet & Display



S. 154



S. 199



S. 265

Buffet & Tableware Melamin



S.269



S.315



S.339

Tableware Tablepresentation



S.354



S.368



S.379

Körbe baskets cestas corbeilles



S.382

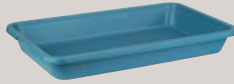

S.401



S.422

Chafing Dish, GN Container & Transport



S.429



S.438



S.479

Bar Café Drinkware



S.496



S. 511



S.518

Servier- & Küchenhelfer kitchen & serving tools herramientas de cocina outils de cuisine



S.532



S.534



S.535

Hauben & Zubehör covers & accessories

„NOVELTIES 2020 Design & Innovation“



FRIDA | S. 196



HAPPY BUFFET | S. 154 -155



S. 79



S. 84, 454

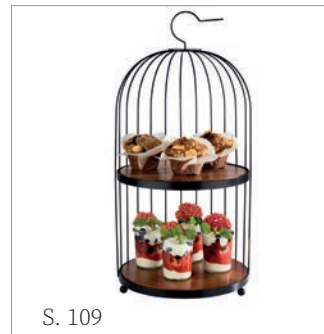

S. 109



S. 114



S. 440

*Streetfood
Style*



S. 277



S. 277



S. 429



S. 441



S. 457

**Bar
Café
Drinkware**



S. 55

S. 54

S. 56

S. 57



ACACIA | S. 45, 293



CAST IRON | S. 270-271



Superboxen „VINTAGE“ | S. 23



S. 58



LOOPS | S. 182-183



INDUSTRIAL | S. 268

Super trendy



VINTAGE | S. 44, 269



S. 84, 429



S. 339



ENAMEL LOOK | S. 252



TIMBER | S. 212



POKE BOWL | S. 175

Super trendy



S. 256

**Buffet & Tableware
Melamin**

DEUTSCH

Artikel	Seite
A	
Abfalleimer	482-483
Abräumwagen	416-417
Abtropfmatte	458
Adapter / Zwischensteg	405
Allzweckgießer	332, 465-466
Antirutschmatte	166
Aschenbecher	478-483
Aufstrichmesser	508
Ausgießer	330, 461-462
Ausstellblech	516
Austernmesser	505
B	
Backblech	408
Backform	515
Backhandschuhe	517
Bain-Marie	382-383, 385-386, 388-396
Bar-Caddy	459
Barlöffel	448
Barmaß	445-447
Barmatte	458
Becher	437-442
Becher Emaille	279
Behälter	146-148
Bento Box	171
Beschriftungsetiketten	312
Beschriftungskarten	306
Besteckablage	259, 400
Besteckbehälter	27-28, 142-144, 146-148, 288, 300-302, 304, 341
Besteckständer	126, 147-148, 418
Besteckständer Melamin	126, 147, 418
Bestecktaschen	351
Beton	14-16, 150, 192-193, 308-310, 341, 344-346, 434, 481
Bierglasträger	62, 435, 474
Blattschale Melamin	195, 221, 250-251
Bonleiste	521
Bonspieß	521
Brennflüssigkeit	400
Brennpastenbehälter Edelstahl	399
Brezel- oder Wurstständer	59, 119
Brotstation	128, 379
Brotkorb	354-363, 367-369
Brotschneidebrett	128-129
Brötchenschütte	357
Brötchenspender Edelstahl	140
Brottasche	370-372
Buffet Kühlset	25
Buffet Kühlset Edelstahl	74-75
Buffet-Set	32, 39, 69
Buffetbrett	58-59
Buffet-Brücke	111
Buffetgestell	109-110, 112, 121, 126
Buffetleiter	122-125
Buffetschilder	308, 310, 312
Buffetständer	15, 35, 104-107, 126, 131, 199
Buffetständer Edelstahl	107, 173, 200, 377
Buffetständer Holz	15, 21, 104, 106
Buffetständer Metall	35, 105-107, 126, 173, 200
Buffetvitrine	67-68, 70-73
Buffetvitrine Edelstahl	70-73
Butter- und Saucenwärmer	294
Butterdose	334
Butterservierer	334
Bürste Bar	456

C	
Caddy	335-341
Cerealispender	27-28, 130-132
Cerealispender Edelstahl	131-132
Chafing Dish	382-393
Chafing Dish Rolltop	389-390, 392, 396
Champagnerkühler	430-431
Cocktailmesser	451, 504
D	
Darioform	515
Deckel	26, 76-78, 124-125, 154, 168, 187, 204, 206, 215, 240, 243, 247, 254, 283, 393-395, 405-407, 410, 535-536
Deckel Edelstahl	386, 388
Dekoriermesser	451, 505
Dip-Schälchen	254-255
Dispenser Saft	27-28, 93, 95, 97-99, 101
Dispenser Saft / Milch	95, 97-98
Display	108
Dosier- & Vorratsflasche	461
Dosierer Zucker	331-333, 465-467
Dosierpumpe	524
Dosierspender	524
Dressingtopf Edelstahl	65-66
Dressingtopf Melamin	65-66
E	
Eier-Box	422
Eierbecher	259, 334
Eierkorb	372
Eierschneider	510
Eis-Kugel-Former	455
Eisbox	19, 84, 454
Eiseimer	426, 453
Eisportionierer	500
Eisschaufel	455
Eiswaffel-Ständer	522
Eiszerkleinerer	455
Emaille-Artikel	278-279, 334
Entkerner	504
Etagère	52, 113, 116, 118-119, 238
F	
Fadenschneider	503
Fast-Food Tablett	64, 423, 476
Fingerfood-Löffel	233, 260-261
Flambierbrenner	470, 510
Flaschenhalter Wein	435
Flaschenkühler	28, 426, 429-434, 437, 460
Flaschenöffner	460, 464
Flaschenträger	435
Fleisch- / Gemüseplatte	29
Folien-Abreibvorrichtung	521
Frischhaltedeckel	26, 283, 536
G	
Gabel Fleisch	412-413, 415, 488-489, 491, 495
Gabel Salat	415, 492, 494
Gebäckpalette	506
Genusspalette	53
Getränkenspender	27-28, 86-102
Getränkewanne	429
Gewürzkasten	524
Gewürzmühle	314-319
Gewürzständer	329
Gläserschiene	435
Glasplatte	60, 109-110
Glasumrand	455
Glocke	483
Gourmetlöffel	296
GN Abtropfgitter	405-406
GN Behälter	401-404, 406-407, 409-411
GN Besteckbehälter	142, 361, 418

GN Buffet-Set	32
GN Buffetgestell	22-24, 110, 366
GN Buffetleiter	122-123
GN Buffetständer	173, 200
GN Buffetvitrine Edelstahl	70, 72
GN Chafing Dish	382, 385-386, 389-393
GN Deckel	404-407, 410
GN Haube	20-21, 32, 174, 190, 354, 364-365, 374, 411, 530-532
GN Konvektomatenblech	408
GN Korb	19, 374
GN Korb Metall	374
GN Korb Polypropylen	19, 354, 356, 361-364
GN Naturschieferplatte	23-24, 49-50
GN Partyplatte	40-41
GN Rost	408
GN Schale Melamin	154, 156, 158, 203, 205, 236, 240-241
GN Servierbrett	53
GN Serviergestell	120
GN Tablett	18, 24, 29, 33-34, 60-61, 160-161, 166-167, 176, 178, 181-182, 185, 187, 190, 193, 200, 204, 208, 211, 214, 218-219, 224, 232, 236, 239, 243, 248-249, 336, 409
GN Tablett Edelstahl	18, 29, 239
GN Tablett Melamin	18, 24, 60-61, 161, 166-167, 176, 178, 181-182, 185, 187, 190, 193, 200, 204, 208, 211, 214, 218-219, 224, 232, 236, 239, 243, 248-249, 336, 409
Gourmetgläser	281
H	
Haube	20-21, 32, 34, 37-38, 45-46, 48, 58-59, 104, 117, 163, 174, 190, 198, 216, 256-258, 289, 291-293, 354, 364-365, 374, 409, 411, 530-535
Haube Rolltop	37, 39, 51, 59, 69-75, 163, 258, 364, 396, 532-533
Haube Rolltop Edelstahl	396
Heizelement	94, 397-399
Hobel	59
Holzbox	57, 141, 287, 339-340
Hummerebrecher	510
Hygieneschutz	59, 119
I	
Induktionskochplatte	383-384, 386-388, 398
Isolierkanne	102-103
K	
Kaffeebecher	259
Kaffeedispenser Edelstahl	94, 102, 397
Kaffeekanne	102-103, 468
Kanne	82-83, 102-103, 467-468
Kanne Saft	82-83
Karaffe Glas	79-82
Kartenhalter	305-312
Käsehobel	505
Käseglocken-Set	39, 59
Kaviarkühler	42, 294
Kellnermesser	464
Kerzenleuchter	342-344
Konditorplatte	47-48, 216, 256-257, 290-291
Konferenzkühler	460
Korb Edelstahl	173, 364, 375-377
Korb Metall	161, 277, 373-376, 378-379
Korb Polypropylen	19, 299, 354-369, 421
Korkenzieher	464
Kronkorkenschale	460
Kugelausstecher	503
Kühlakku	26, 67-78, 81,

	87, 96, 460, 537
Kühlbox	17, 19, 25, 61, 69, 74-75
Kühlkaraffe	81
Kühlmanschette	434
Kühlschale	26, 76-78
Kühltablett	17, 71, 73
L	
Likör- und Fondanttrichter	513
Limettenpresse	452, 518
Löffel	260-261, 296, 412-415, 487-495, 500-502, 512
Löffel Backen	512
Löffel Feinkost	501
Löffel Fingerfood	233, 260-261
Löffel Frittieren	512
Löffel Gourmet	296
Löffel Salat	415, 492, 494
Löffel Saucen, Dressing	415, 493, 495, 501
Löffel Spaghetti	414, 493
M	
Magnet-Messerhalter	521
Mandoline	513
Menage	248, 323-329
Messbecher	514
Messlöffelsatz	500
Metallrahmen für Induktionskochplatte	386-388, 398
Milchgießer/-kännchen	85, 333, 467-469
Milchkanne	99-100
Minis	262-265
Moscow Mule Becher	437-439
Mühle Pfeffer	314-319
Mühle Salz	314-319
Multi Rack Edelstahl	135-136
Multibox	140
Muscheltopf	283
Müslispender	27-28, 130-132
N	
Naturschiefer	23-24, 39, 49, 50-52, 54, 118-119, 286, 288-289, 319, 475
Naturschieferplatte	23-24, 50-51, 288-289
P	
Palmbattschale Melamin	250-251
Parmesan Menage	328
Partyplatte	40-41
Pastateller Melamin	249
Pendelschäler	504
Permanent-Ausgießer	462
Pfanne	526
Pfannenwender	415, 486, 491, 494
Pfeffermühle	314-319
Pinself	518
Pinzettzange	456, 497
Pitcher	83, 435
Pizzaform	527
Pizzaschaufel	509, 517
Pizzaschneider	509
Platzsets	347-351
Platzteller	297
Pommes-Frites-Seiher	512
Porzellan	383, 388
Q	
Quetschflasche	523
R	
Rechnungstablett	313, 477
Reinigungsbürste	456-457
Rezeptionsglocke	483
Rolltop-Set	39, 51
Rührglas	461

S

Saftdispenser	27-28, 95, 97-99, 101
Saftkanne	82-83
Salzmühle	314-319
Sauciere	295
Schälchenspender	136-137
Schale Beton	14-16
Schale Edelstahl	26, 34, 276, 376
Schale Emaille	278-279, 334
Schale Holz	57, 284
Schale Melamin	26, 78, 121, 137, 154-159, 168, 175, 177, 179-180, 183-184, 186-187, 189, 191-193, 195, 198, 201-208, 212, 215, 221-223, 225-229, 231-232, 234-243, 246-255, 258, 262-265, 470
Schaufel Eis	455
Schaufel Mehl	517
Schaumlöffel	414, 487, 490-491
Schaumspesering	514
Schiefer	23-24, 39, 49-52, 54, 118-119, 286, 288-289, 319, 475
Schilder	308, 311, 536
Schlüsselschnur	463
Schneebesen	511
Schneidbrettständer	522
Schneidebrett	18, 128-129, 379, 451
Schöpflöffel	412-415, 487-490, 495
Sektkühler	426-429, 431-432
Senftöpfchen	325
Service Tower	134
Servier- / Tortenplatte Edelstahl	38, 47, 290
Servier- / Tortenplatte Holz	45, 117, 293
Servier- / Tortenplatte Melamin	46, 48, 183, 216, 256-257, 291-292
Servierbrett	53-57, 284-287, 341, 475
Serviergabel	415, 495
Serviergestell	114-116, 118-120, 282
Servierkelle	268, 471
Servierlöffel	412-415, 487-491, 494
Servierpfanne	35, 270-271, 275, 525, 526
Servierpfanne Schmiedeeisen	526
Servierpfanne Gusseisen	270-271, 525
Serviertablett	38, 42-44, 62-63, 269, 423, 472-475, 516
Servierwagen	416-417
Serviettenhalter	149-151
Serviettenringe	298
Serviettentaschen	351
Shaker	443-444
Sieb	449, 451, 511-513
Snackbox	268, 275
Snackholder	272-275
Snackpresenter	127
Sortierbox	422
Spachtel	508
Sparschäler	503
Speisenwärmer	382-391
Spießständer / Spieße	294
Spritzflasche	330, 461
Standascher	482-483
Ständer	199, 329, 428, 522
Ständer Wein- / Sektkühler	428
Staubkappen	463
Stielkasserolle	296
Stift	312
Stößel	450
Streichpalette	506
Streuer	320-322, 512
Streuer Pfeffer	314-319, 322
Streuer Salz	314-319, 322, 512
Superbox	22-24
Suppenkelle	492
Suppentopf	391, 394-396

Sushiboard Melamin	180-181, 185, 192, 207, 221, 223, 225, 230
T	
Table Caddy	146, 299, 335-336, 338-341
Tablett	18, 43-44, 62-63, 269, 313, 357, 409, 423, 472-477, 516
Tablett Edelstahl	18, 29-39, 42-44, 269, 313, 471-473, 477, 516
Tablett Fast Food	64, 423, 476
Tablett Holz	63-64, 162, 165, 336, 475, 476
Tablett Melamin	18, 24, 43, 60-62, 128, 160-161, 165-167, 176-178, 181-183, 185, 187, 190, 192-193, 199-202, 204-205, 207-211, 213-221, 223-225, 230-233, 236-241, 243-245, 248-249, 251, 258, 265, 319, 379, 472, 474
Tasse Melamin	259
Teebox	140-141
Teebrühsieb	85, 470
Teekanne ASIA	85, 467
Teigschaber / Abstecher	508
Teller Emaille	278
Teller Fingerfood	63, 194, 239, 259
Teller Melamin	63, 169, 177, 179, 180, 182, 184-185, 188, 194, 213, 222, 225, 230, 245-246, 252-253, 258-259, 264
Thermo Tablett-Set	67-68
Thermo-Set	75
Tischrestehälter	145-148, 302-304
Tischaufsteller	307, 311
Tischkartenhalter	305-310, 312
Tischkrümelentferner	147, 313, 477
Tischsets	347-350
Tortenheber	493, 495
Tortenmesser	493
Tortenplatte	38, 45-48, 117, 183, 216, 256, 257, 290-293
Tortenring	515
Transportwagen	416-417
Trenner	358
Tretbeutelhalter	483
Trinkbecher	89-93, 436
Trinkhalme	457
Tropfenschale Melamin	90-91, 93
U	
Universalbox	139-140, 524
Universalkanne	85, 468, 514
Untersetzer Edelstahl	298
Untersetzer Kork	89-92, 526
Untersetzer Naturschiefer	51, 289, 319
V	
Vase	346
Verschluss	462-463
Verschluss Wein / Champagner	462
Vorratsglas	138-139, 519-520
W	
Wachspapier	53, 269, 275
Wanne	18, 84, 423, 429
Warenträger	40, 347
Wärme-Kies	400
Warnschild	527, 537
Wasserbadschüssel	513
Wasserspender	86-93, 97
Weck Gläser	280-282
Wein-Vakuum-Pumpe	463
Weinkühler	426-429, 431-432
Weinkühlerständer	428
Weinpumpe-Ersatzstopfen	463
Wender	413-415, 486, 489-491, 494, 506, 507
Windaschenbecher	478-481
Windlicht	345

Z

Zange	456, 487, 496-500
Ziseliermesser	503
Zitronenschnitzelpresse	470
Zitruspresse	451, 518
Zitrusteiler	452
Zuckerdosierer	331-333, 465-467
Zuckerkugel	333, 470
Zuckerspender	333, 467
Zuckertüten-Box Edelstahl	469
Zutatenbehälter	459
item	page
A	
adapter	405
airtight cover	26, 283, 536
ashtray	478-483
B	
bain marie bailing bowl	513
bain marie	382-383, 385-386, 388-396
baking mittens	517
baking pan	515
baking sheet	408
bar caddy	459
bar knife	451, 504
bar shaker	443-444
bar spoon	448
barrel mug	437-442
basket metal	161, 277, 373-376, 378-379
basket polypropylene	19, 299, 354-369, 421
basket stainless steel	173, 364, 375-377
beaker	279
beer rack	62, 435, 474
Bento Box	171
beverage dispenser	27-28, 86-102, 459
beverage tub	429
bill presenter	313, 477
bill rail	521
bill spike	521
bottle cooler	28, 426, 429-434, 437, 460
bottle fuel	399
bottle opener	460, 464
bottle rack	435
bowl concrete	14-16
bowl enamel	278-279, 334
bowl holder	136-137
bowl melamine	26, 78, 121, 137, 154-159, 168, 175, 177, 179, 180, 183-184, 186-187, 189, 191-193, 195, 198, 201-208, 212, 215, 221-223, 225-229, 231-232, 234-243, 246-255, 258, 262-265, 470
bowl stainless steel	26, 34, 276, 376
bowl wood	57, 284
bread basket	370-372
breadbox	354-363, 367-369
brush	518
buffet bridge	111

buffet ladder	122-125
buffet set	32, 39, 69
buffet signs	308, 310, 312
buffet stand	15, 35, 104-107, 126, 109-110, 112, 121, 131, 199
buffet stand chrome plated steel	35, 105-107, 126, 173, 200
buffet stand stainless steel	107, 173, 200, 377
buffet stand wood	15, 21, 104, 106
Buffett-board	58-59
butter and sauce pan warmer	294
butter dish	334
C	
caddy	335-341
cake lifter	493, 495
cake plate melamine	46, 48, 183, 216, 256-257, 291-292
cake plate stainless steel	38, 47, 290
cake plate wood	45, 117, 293
cake setting ring	515
cake slice	493
cake stand	38, 45-48, 117, 183, 216, 256-257, 290-293
candle holder	342-344
canele / decorating knife	503
canister with lid	138-139, 519-520
cap bowl	460
cast iron pan	270-271, 525
caviar cooler	42, 294
cereal dispenser	27-28, 130-132
cereal dispenser stainless steel	131-132
Chafing Dish	382-393
Chafing Dish Rolltop	389-390, 392, 396
champagne bowl	426-429, 431-432
champagne saver	462
cheese dish	328
cheese slicer	505
chefs blow torch	470, 510
chopping board	18, 128-129, 379, 451
citrus squeezer	451, 518
citrus wedger	452
cleaning brush	456-457
clingfilm tear-off dispenser	521
cloche / dome cover	483
coaster cork, wood	89-92, 526
coaster natural slate	51, 289, 319
coaster stainless steel	298
coffee cup	259
coffee dispenser stainless steel	94, 102, 397
coffee pot	102-103, 468
condiment container	524
condiment holder	459
confectionery funnel	513
conference bottle cooler	460
container	18, 84, 146-148, 423, 429
cool collar	434
cooler	26, 67-78, 81, 87, 96, 460, 537
cooling bowl	26, 76-78
cooling box	17, 19, 25, 61, 69, 74-75
cooling carafe	81
cooling plates	17, 71, 73
corer	504
corkscrew	464
cornet stand	522
cover	20-21, 26, 32, 34, 37-38, 45-46, 48, 58-59, 76-78, 104, 117, 124-125, 154, 163, 168, 174, 187, 190, 198, 206, 215-216, 240, 243, 247, 254, 256-258, 283, 289, 291-293, 354, 364-365, 374, 405-407, 409-411, 530-536

cover stainless steel	386, 388	GN tray	18, 24, 29, 33-34, 60-61, 160-161, 166-167, 176, 178, 181-182, 185, 187, 190, 193, 200, 204, 208, 211, 214, 218-219, 224, 232, 236, 239, 243, 248-249, 336, 409	natural slate tray	23-24, 50-51, 288-289	snackbox	268, 275
crumber	147, 313, 477	GN tray melamine	18, 24, 60-61, 161, 166-167, 176, 178, 181-182, 185, 187, 190, 193, 200, 204, 208, 211, 214, 218-219, 224, 232, 236, 239, 243, 248-249	non slip mat	166	snackpresenter	127
cup melamine	259	GN tray stainless steel	18, 29, 239	O		snap mesh tea ball	85, 470
curler	59	GN-container	401-404, 406-407, 409-411	oyster knife	505	soup ladle	492
cutlery	14-16, 150, 192-193, 308-310, 341, 344-346, 434, 481	GN-convection oven trays	408	P		soup pot	391, 394-396
cutlery bag	351	GN-drainer	405-406	palm leaf melamine	250-251	spaghetti spoon	414, 493
cutlery basket	126, 147-148, 418	GN-lid	404-407, 410	pan	35, 270-271, 275, 525-526	spatula	506
cutlery basket melamine	126, 147, 418	gourmet glasses	281	paring knife	358	spice mill	314-319
cutlery organizer	27-28, 142-144, 146-148, 288, 300-302, 304, 341	graduated jug	514	party spoon	233, 260-261, 296	spider spoon	512
cutlery rest	259, 400	granite chips	400	partytray	40-41	spoon	260-261, 296, 412-415, 487-495, 500-502, 512
cutting board	128, 129	gravy boat	295	pasta plate melamine	249	squeeze bottle	330, 461, 523
cutting board rack	522	greaseproof paper squares	53, 269, 275	pastry spatula	506	stand for wine / champagne bowl	428
D		H		pedal bin	483	standing ashtray	482-483
dariol moulds	515	heating unit	94, 397-399	peeler	503	strainer	449, 451, 511-513
decorating knife	451, 505	hygienic cover	59, 119	pen	312	straws	457
decorator / zester	503	I		pepper mill	314-319, 322	sugar dispenser	331-333, 465-467
delicatessen spoon	501	ice ball former	455	pitcher	82-83, 102-103, 435, 467-468	sugar pocket holder	469
designation cards	306	ice box	19, 84, 454	pizza cutter	509	sugar pot	333, 470
dip bowl	254-255	ice bucket	426, 453	pizza dish	527	superbox	22-24
dispenser	27-28, 86-102	ice cream scoop	500	pizza peel	509, 517	sushiboard melamine	180-181, 185, 192, 207, 221, 223, 225, 230
dispenser dosing	524	ice crusher	455	placemat	347-350	swivel peeler	504
dispenser sugar	331-333, 465-467	ice scoop	455	plate enamel	278	T	
display	40, 108, 347	induction plate	383-384, 386-388, 398	plate melamine	63, 169, 177, 179-180, 182, 184-185, 188, 194, 213, 222, 225, 230, 245-246, 252-253, 258-259, 264	table caddy	146, 299, 335-336, 338-341
display tray	516	J		plate tray	297	table garbage bin	145-148, 302-304
dosing pump	524	jigger	445-447	plate warmer	382-391	table stands	305-312
dough scraper	508	jug	85, 468, 514	porcelain	383, 388	tea-box	140-141
dressing pot melamine	65-66	juice and milk dispenser	95, 97-98	pourer	332, 465-466	teapot ASIA	85, 467
dressing pot stainless steel	65-66	juice dispenser	27-28, 93, 95, 97-99, 101	pourer cleaning brush	456	thermo set	75
dressing/sauce spoon	415, 493, 495, 501	juice pitcher	82-83	pourers	330, 461-462	thermo tray	67-68
drinking cups	89-93, 436	K		pouring container	461	tong	456, 487, 496-500
drip mat	458	key cord	463	pretzel-/ sausage stand	59, 119	tray	18, 29, 38, 42-44, 52, 62-63, 113, 116, 118-119, 238, 269, 313, 357, 409, 423, 472-477, 516
drip tray	90-91, 93	L		R		tray melamine	18, 24, 43, 60-62, 128, 160-161, 165-167, 176-178, 181-183, 185, 187, 190, 192-193, 199-202, 204-205, 207-211, 213-221, 223-225, 230-233, 236-241, 243-245, 248-249, 251, 258, 265, 319, 379, 472, 474
dust & fly cap	463	labeling labels	312	refrigerated buffet display	25	tray stainless steel	18, 29-39, 42-44, 269, 313, 471-473, 477, 516
E		labels	308, 311, 536	refrigerator butter dish	334	tray wood	63-64, 162, 165, 336, 475-476
egg basket	372	ladle	412-415, 487-490, 495	ring bell	483	turner	413-415, 486, 489-491, 494, 506-507
egg cutter	510	leaf melamine	195, 221, 250-251	roll / bun basket	357	tweezer	456, 497
egg holder	259, 334	lemon slice squeezer	470	roll dispenser stainless	140	U	
eggs box	422	lime press	452, 518	rolltop cover	37, 39, 51, 59, 69-75, 163, 258, 364, 396, 532-33	universal box	139-140, 524
enamel	278-279, 334	lobster cracker	510	rolltop set	37, 39, 51, 59	V	
F		M		rolltop-cover stainless steel	396	vacuum jug	102-103
fingerfood plate	63, 194, 239, 259	magnetic knife rack	521	S		vacuum wine pump	463
flower vase	346	mandolin	513	salad fork	415, 492, 494	W	
fork	415, 495	meat platter	400	salad spoon	415, 492, 494	waiter's corkscrew	464
frame for induction plate	386-388, 398	meatfork	412-413, 415, 488-489, 491, 495	salt mill	314-319, 322, 512	Weck-bottles	280-282
free flow pourer	462	melon baller	503	sandwich knife	508	whisk	511
fry dripping tray	512	menage	248, 323-329	sauté pan / mini sauce pan	296	wind lights	345
G		milk dispenser	99-100	scoop	517	wine bowl	426-429, 431-432
glass carafe	79-82	milk jug	85, 333, 467-469	scraper	508	wine pump stopper	463
glass plate	60, 109-110	mini bowl	262-265	service tower	134	winebottle-stand	435
glass rack	435	mixing glass	461	service trolley	416-417	woodbox	57, 141, 287, 339-340
glass rimmer	455	Moscow Mule barrel mug	437-439	serving board	53-57, 284-287, 341, 475	wrought-iron pan	526
GN 1/1 buffet set	32	mousse ring	514	servicing cup	272-275		
GN 1/1 dispenser	142, 361, 418	muddler	450	servicing spoon	412-415, 487-491, 494		
GN basket	19, 374	multi rack stainless steel	135-136	servicing stand	114-116, 118-120, 199, 282, 329, 428, 522		
GN basket metal	374	multibox	140	servicing stand/rack	329		
GN basket polypropylene	19, 354, 356, 361-364	mussel pot	283	servicing trolley	388-389, 416-417		
GN bowl, square melamine	154, 156, 158, 203, 205, 236, 240-241	mustard glass	325	servicing trowel	268, 471		
GN buffet ladder	122-123	N		set measuring spoon	500		
GN buffet stand	22-24, 110, 173, 200, 366	napkin bag	351	shaker	320-322, 512		
GN Chafing Dish	382, 385-386, 389-393	napkin holder	149-151	shape sorter	422		
GN cover	20-21, 32, 174, 190, 354, 364-365, 374, 411, 530-532	napkin rings	298	showcase	67-68, 70-73		
GN grid	408	natural slate	23-24, 39, 49-52, 54, 118-119, 286, 288-289, 319, 475	showcase stainless steel	70-73		
GN natural slate tray	23-24, 49-50			skewer rack/skewer	294		
GN partytray	40-41			skimmer	414, 487, 490-491		
GN refrigerated buffet display	70, 72			skimmer spoon	512		
GN serving board	53			slate	23-24, 39, 49-52, 54, 118-119, 286, 288-289, 319, 475		
GN serving stand	120			snack tray	64, 423, 476		

artículos **pág.**

A

abre ostras 505
 abridor 460, 464
 acumulador de frío 26, 67-78, 81, 87, 96, 460, 537
 adaptador 405
 aro anti-goteo 90-91, 93
 aro de tarta 515
 aro redondo para semifríos 514
 azucarero 331-333, 465-467, 470
 azucarero para bolsitas 469

B

bano maría 382-383, 385-386, 388-396
 bajo plato 297
 bandeja 18, 38, 42-44, 52, 62-63, 113, 116, 118-119, 238, 269, 313, 357, 409, 423, 472-477, 516
 bandeja acero inoxidable 18, 29-39, 42-44, 269, 313, 471-473, 477, 516
 bandeja autoservicio y snacks 64, 423, 476
 bandeja de pizarra natural 2324, 39, 49-52, 54, 118-119, 286, 288-289, 319, 475
 bandeja de vidrio 60, 109-110
 bandeja isotérmica 75
 bandeja madera 63-64, 162, 165, 336, 475-476
 bandeja melamina 18, 24, 43, 60-62, 128, 160-161, 165-167, 176-178, 181-183, 185, 187, 190, 192-193, 199-202, 204-205, 207-211, 213-221, 223-225, 230-233, 236-241, 243-245, 248-249, 251, 258, 265, 319, 379, 472, 474
 bandeja para sushi melamina 180-181, 185, 192, 207, 221, 223, 225, 230
 bandeja party 40-41
 bandeja pastelería 408, 516
 bandeja tartas acero inoxidable 38, 47, 290
 bandeja tartas madera 45, 117, 293
 bandeja tartas melamina 46, 48, 183, 216, 256-257, 291-292
 bandeja termo 67-68
 bandejas refrigeradas 17, 71, 73
 barra magnética para cuchillos 521
 barreño botellines 429
 batidor 511
 bento box 171
 bol refrigerado 26, 76-78
 bolsa cubiertos 351
 bomba de salsa 524
 bomba de vacío para vino 463
 bote con tapa 138-139, 519-520
 bote dosificador flexible 523
 bote vertedor universal 332, 465-466
 botella „store & pour“ 461
 botella de combustible líquido 399
 botella exprimible 330, 461
 brocha 518

C

caballetes de mesa 307, 311
 cacerola 526
 caddy de mesa 146, 299, 335-341
 cafetera 102-103, 468
 caja de pan para buffet 354-363, 367-369
 caja dispensadora 139-140, 524
 caja madera 57, 141, 287, 339-340
 caja para huevos 422
 caja para té 140-141

caja surtida 422
 cajón para cubiertos 27-28, 142-144, 146-148, 288, 300-302, 304, 341, 418
 calentador de mantequilla y salsa 294
 caliente platos 382-391
 campana 20-21, 32, 34, 37-38, 45-46, 48, 58-59, 104, 117, 163, 174, 190, 198, 216, 256-258, 289, 291-293, 354, 364-365, 374, 409, 411, 530-535
 campana abatible 37, 39, 51, 59, 69-75, 163, 258, 364, 396, 532-533
 campana esférica 483
 campana rolltop 396
 candelabro 342-344
 carro de servicio 416-417
 cazo para baño maría 513
 cazo recto bajo 96
 cenicero 478-483
 cenicero de pie 482-483
 cepillo de limpieza 456-457
 cesta acero inoxidable 173, 364, 375-377
 cesta de huevos 372
 cesta metal 161, 277, 373-376, 378-379
 cesta para bollos 357
 cesta para cubiertos 126, 147-148
 cesta para cubiertos melamina 126, 147, 418
 cesta polipropileno 19, 299, 354-369, 421
 Chafing Dish 382-393
 Chafing Dish Rolltop 389-390, 392, 396
 coctelera 443-444
 colador 449, 451, 511-513
 conjunto aperitivo 248, 323-329
 corta huevos 510
 corta pasta 508
 cortador de cítricos 452
 cortador de pizza 509
 cubeta 18, 84, 423, 429
 cubierta higiénica antialiento 59, 119
 cubiertos 14-16, 150, 192-193, 308-310, 341, 344-346, 434, 481
 cubitera 19, 84, 454
 cubitera isotérmica 426, 453
 cubitera para vino y cava 426-429, 431-432
 cubo champañera 430-431
 cuchara 260-261, 296, 412-415, 487-495, 500-502, 512
 cuchara de espaguetis 414, 493
 cuchara gourmet 296, 501
 cuchara para ensalada 415, 492, 494
 cuchara para helado 500
 cuchara para servir 412-415, 487-491, 494
 cuchara party 233, 260-261
 cucharilla de cóctel 448
 cucharón 412-415, 487-490, 495
 cucharón de salsa/alino 415, 493, 495, 501
 cucharón de sopa 492
 cuchillo acanalador 451, 505
 cuchillo curvado 358
 cuchillo de decoración cincelador 503
 cuchillo para cóctel 451, 504
 cuchillo para untar 508
 cuenco acero inoxidable 26, 34, 276, 376
 cuenco esmalte 278-279, 334
 cuenco hormigón 14-16
 cuenco madera 57, 284

cuenco melamina 26, 78, 121, 137, 154-159, 168, 175, 177, 179-180, 183-184, 186-187, 189, 191-193, 195, 198, 201-208, 212, 215, 221-223, 225-229, 231-232, 234-243, 246-255, 258, 262-265, 470
 cuenco mini 262-265
 cuenco para chapas 460
 cuenco para dip 254-255

D

dispensador 27-28, 86-102
 dispensador de bebidas 27-28, 86-102, 459
 dispensador de bocadillos 127
 dispensador de café acero inoxidable 94, 102, 397
 dispensador de cereales 27-28, 130-132
 dispensador de cereales acero inoxidable 131-132
 dispensador de especias 459
 dispensador de film 521
 dispensador de leche 99-100
 dispensador de panecillos acero inoxidable 140
 dispensador de salsa 524
 dispensador de zumo 27-28, 93, 95, 97-99, 101
 dispensador en escalera 122-125
 dispensador en escalera acero inoxidable 135-136
 dispensador mixto zumo y leche 95, 97-98

E

embudo dosificador 513
 enfriador de botellas 28, 426, 429-434, 437, 460
 enfriador de caviar 42, 294
 enfriador múltiple 460
 escurridor de fritos 512
 esmalte 278-279, 334
 espátula 413-415, 486, 489-491, 494, 506-507
 espátula plancha 508
 especiero 524
 espumadera 414, 487, 490-491
 espumadera para fritos 512
 esterilla antideslizante 166
 esterilla escurridora 458
 estructura o marco para placa de inducción 386-388, 398
 etiquetas 308, 311-312, 536
 expositor 40, 108, 347
 expositor buffet 109-110, 112, 121, 126
 expositor buffet frío 17, 19, 25, 61, 69-70, 72, 74-75
 expositor de buffet 15, 35, 104-107, 126, 131, 199
 expositor de buffet acero inoxidable 107, 173, 200, 377
 expositor de buffet cromado 35, 105-107, 126, 173, 200
 expositor de buffet madera 15, 21, 104, 106
 exprimidor cítricos 451, 518

F

flaneras 515
 florero 346
 fuente de servicio 29
 fuente en forma de hoja melamina 195, 221, 250-251
 fuente para la mesa 35, 270-271, 275, 525-526
 fuente servicio 400

funda de frío 434

G

GN 1/1 dispensador de cubiertos 142, 361, 418
 GN 1/1 set de buffet 32
 GN bandeja 18, 24, 29, 33-34, 60-61, 160-161, 166-167, 176, 178, 181-182, 185, 187, 190, 193, 200, 204, 208, 211, 214, 218-219, 224, 232, 236, 239, 243, 248-249, 336, 409
 GN bandeja acero inoxidable 18, 29, 239
 GN bandeja de pizarra natural 23-24, 49-50
 GN bandeja melamina 18, 24, 60-61, 161, 166-167, 176, 178, 181-182, 185, 187, 190, 193, 200, 204, 208, 211, 214, 218-219, 224, 232, 236, 239, 243, 248-249
 GN bandeja party 40-41
 GN campana 20-21, 32, 174, 190, 354, 364-365, 374, 411, 530-532
 GN cesta 19, 374
 GN cesta metal 374
 GN cesta polypropileno 19, 354, 356, 361-364
 GN Chafing Dish 382, 385-386, 389-393
 GN cubeta 401-404, 406-407, 409-411
 GN cubeta para hornos de convección 408
 GN cuenco cuadrado melamina 154, 156, 158, 203, 205, 236, 240-241
 GN escurridor 405-406
 GN rejilla 408
 GN soporte buffet 120
 GN soporte para buffet 173, 200
 GN tabla de servir 53
 GN tapa 404-407, 410
 granulado térmico 400

H

huevera 259, 334

I

infusor de té, pinza con malla 85, 470

J

jarra 82-83, 85, 102-103, 435, 467-468, 514
 jarra de leche 85, 333, 467-469
 jarra de vidrio 79-82
 jarra de zumo 82-83
 jarra fría 81
 jarra graduada 514
 jarra termo 102-103
 juego de cucharas medidoras 500

L

lavero enrollable 463

M

mandolina 513
 manoplas de panadero 517
 mantelín 347-350
 mantequillera 334
 mantequillera para nevera 334
 marco pastelero 515
 medidor jigger 445-447
 mejillonera 283
 molde de cubitos de hielo esféricos 455
 molde de pizza 527
 molinillo de pimienta 314-319, 322
 molinillo de sal 314-319, 322, 512
 molino de la especia 314-319
 mortero 450
 Moscow Mule taza 437-439
 multibox 140

O	
olla para buffet	391, 394-396
organizador de bar	459
P	
pajás	457
pala	517
pala de hielo	455
pala de pizza	509, 517
pala de tartas	493, 495
paleta para servir	268, 471
paleta pastelera	506
panera	370-372
papel alimenticio	53, 269, 275
papelera de sobremesa	145-148, 302-304
pelador reversible	503-504
picadora de hielo	455
pie porta champañera / vino	428
piezas indicadores buffet	308, 310, 312
pinchanotas	521
pinza	456, 487, 496-500
pinza bogavante	510
pinza de emplatar	456, 497
pinza exprime limón	470
pizarra	23-24, 39, 49-52, 54, 118-119, 286, 288-289, 319, 475
placa de inducción	383-384, 386-388, 398
plato esmalte	278
plato melamina	63, 169, 177, 179-180, 182, 184-185, 188, 194, 213, 222, 225, 230, 245-246, 252-253, 258-259, 264
plato para el aperitivo	63, 194, 239, 259
plato para pasta melamina	249
polvoreador	320-322, 512
porcelana	383, 388
porcionador de pastel	493
porta botellas	435
porta cuenta	313, 477
porta vasos de cerveza	62, 435, 474
porta-etiquetas	305-310, 312
portafichas	521
portatarjetas	305-312
portavelas antiviento	345
posavasos acero inoxidable	298
posavasos corcho, madera	89-92, 526
posavasos pizarra natural	51, 289, 319
prensa de limón	452, 518
punteo de buffet	111
Q	
quesera parmesano	328
quita-rabillito	504
R	
rack de copas	435
rack dispensador para bols	136-137
rebanador de queso	505
recipiente organizador	146-148
recogemigas	147, 313, 477
reposa cuchara	259, 400
resistencia	94, 397-399
ribeteador de vasos	455
rizador	59
rotulador	312
S	
sacacorchos	464
sacacorchos de camarero	464
salsera	295
salsera acero inoxidable	65, 66
salsera melamina	65, 66
sartén de hierro fundido	270, 271, 525
sartén forjada	526
service tower	134
servilletero	149-151
servilleteros	298
set de buffet	32, 39, 69
set de buffet refrigerado	25
set rolltop	37, 39, 51, 59
snackbox	268, 275
soplete de cocina para flambear	470, 510
soporte	199, 329, 428, 522
soporte a pedal	483
soporte cucuruchos	522
soporte para botella de vino	435
soporte para brochetas	294
soporte para buffet	22-24, 110, 366
soporte para embutidos	59, 119
soporte para pastel	38, 45-48, 117, 183, 216, 256-257, 290-293
soporte para tablas	522
soporte platos	114-116, 118-120, 282
soporte salsas y condimentos	329
superbox	22-24
T	
tabla de corte	128-129
tabla de servir	53-57, 284-287, 341, 475
tabla para cortar	18, 128-129, 379, 451
tabla para el buffet	58-59
tapa	26, 76-78, 124-125, 154, 168, 187, 204, 206, 215, 240, 243, 247, 254, 283, 405-407, 410, 535-536
tapa de acero inoxidable	386, 388
tapa hermética	26, 283, 536
tapete escurridor	458
tapón antipolvo	463
tapón vertedor	462
tapones al vacío para el vino	463
tarjetas	306
tarros gourmet	281
taza	437-442
taza de café	259
taza melamina	259
tenedor de carne	412-413, 415, 488-489, 491, 495
tenedor de servicio	415, 495
tenedor de servicio para ensalada	415, 492, 494
tetera ASIA	85, 467
timbre	483
V	
vaciador de melón redondo	503
vaso coctelero	279
vaso mezclador vertedor	461
vaso para servir	272-275
vasos	89-93, 436
vasos mostaza	325
vertedor continuo	462
vertedores	330, 461-462
vitrina de buffet	67-68, 70-73
W	
Weck-botellas	280-282

FRANÇAIS

item	pág.
A	
accumulateur de froid	26, 67-78, 81, 87, 96, 460, 537
adaptateur	405
anneau coupe-gouttes	90-91, 93
anneaux à serviettes 2	98
ardoise	23-24, 39, 49-52, 54, 118-119, 286, 288-289, 319, 475
assiette creuse mélamine	249
assiette de présentation	297
assiette émail	278
assiette mélamine	63, 169, 177, 179-180, 182, 184-185, 188, 194, 213, 222, 225, 230, 245-246, 252-253, 258-259, 264
assiette pour apéritif	63, 194, 239, 259
B	
bac	18, 84, 423, 429
bac à couverts	27-28, 142-144, 146-148, 288, 300-302, 304, 341
bain-marie	382-383, 385-386, 388-396
barre aimantée pour couteaux	521
barre porte-bons	521
base bois	57, 141, 287, 339-340
bassine à glace	429
Bento Box	171
beurrer	334
boîte à beurre pour le frigo	334
boîte à épices ou ingrédients	524
boîte à fruits et ingrédients	459
boîte à œufs	422
boîte à pain pour le buffet	354-363, 367-369
boîte à thés et infusions	140-141
boîte de tri	422
boîte distributrice	139-140, 524
bol béton	14-16
bol bois	57, 284
bol couvercle inox	26, 34, 276, 376
bol émail	278-279, 334
bol mélamine	26, 78, 121, 137, 154-159, 168, 175, 177, 179-180, 183-184, 186-187, 189, 191-193, 195, 198, 201-208, 212, 215, 221-223, 225-229, 231-232, 234-243, 246-255, 258, 262-265, 470
bol mélangeur	279
bol mini	262-265
bol récupérateur de capsules	460
bol réfrigéré	26, 76-78
bordeur à verres	455
bouchon à vide pour le vin	463
bouchon anti-poussières et anti-insectes	463
bouchons verseurs	330, 461-462
boule à thé avec pince	85, 470
bouteille „store & pour“	461
bouteille de combustible liquide	399
bouteille isotherme	102-103
bouteille verseuse souple	523
brosse lave	456-457
broyeur à glaçons	455
C	
caddy de table	146, 299, 335-336, 338-341
cadre support inox pour plaque induction	386-388, 398
caisson thermo	67-68
carafe en verre	79-82
casserole	526
casserole à moules	283
cendrier	478-483
cendrier sur pied	482-483
cercle à gâteaux	515
cercle à mousse rond	514
Chafing Dish	382-393
Chafing Dish Rolltop	389-390, 392, 396
chalumbeau e cuisine	470, 510
chandelier	342-344
chariot de service	416-417
chauffe-plat	382-391
chevalets de table	307, 311
cloche	20-21, 32, 34, 37-38, 45-46, 48, 58-59, 104, 117, 163, 174, 190, 198, 216, 256-258, 289, 291-293, 354, 364-365, 374, 409, 411, 530-535
cloche basculante	37, 39, 51, 59, 69-75, 163, 258, 364, 396, 532-533
cloche demi-sphère	483
cloche rolltop	396
coquetier	259, 334
corbeille	370-372
corbeille à petits pains	357
corbeille acier inox	173, 364, 375-377
corbeille métal	161, 277, 373-376, 378, 379
corbeille polypropylène	19, 299, 354-369, 421
coupe-agrumes	452
coupe-œufs	510
coupe-pâte	508
coupe-pizza	509
couteau à huitres	505
couteau à tarte	493
couteau à tartiner	508
couteau cannelé	451, 505
couteau cocktail	451, 504
couteau d'office bec d'oiseau	358
couteau tranche-fromage	505
couteau zesteur	503
couteau zesteur cannelé	503
couvercle	26, 76-78, 124-125, 154, 168, 187, 204, 206, 215, 240, 243, 247, 254, 283, 405-407, 410, 535-536
couvercle acier inox	386, 388
couvercle hermétique	26, 283, 536
couverts	14-16, 150, 192-193, 308-310, 341, 344-346, 434, 481
cuillère	260-261, 296, 412-415, 487-495, 500-502, 512
cuillère à cocktail	448
cuillère à glace	500
cuillère à salade	415, 492, 494
cuillère à sauce	415, 493, 495, 501
cuillère à spaghettis	414, 493
cuillère de service	412-415, 487-491, 494
cuillère gourmet	296, 501
cuillère party	233, 260-261
D	
décapulateur	460, 464
dérouleur de film	521
distributeur	27-28, 86-102
distributeur à jus de fruit	27-28, 93, 95, 97-99, 101
distributeur à lait	99-100
distributeur de boissons	27-28, 86-102, 459
distributeur de café acier inox	94, 102, 397
distributeur de céréales	27-28, 130-132
distributeur de céréales acero inox	131, 132

distributeur de petits pains acier inox	140
distributeur mixte à lait et à jus de fruit	95, 97-98
doseur à sauce	524
E	
écumoire	414, 487, 490-491
écumoire à friture	512
égouttoir à couverts	126, 147-148, 418
égouttoir à couverts mélamine	126, 147, 418
égouttoir à friture	512
émail	278-279, 334
entonnoir à piston	513
équeuteur	504
étagère	52, 113, 116, 118-119, 238
étiquettes	306, 308, 311-312, 536
F	
flacon pulvérisateur	330, 461
forme à gateaux	515
fouet	511
fourchette à viande	412-413, 415, 488-489, 491, 495
fourchette de service	415, 495
fourchette de service pour la salade	415, 492, 494
frisette	59
G	
gants de boulanger	517
GN 1/1 bac à couverts	142, 361, 418
GN 1/1 set catering: plateau + cloche	32
GN bac	401-404, 406-407, 409-411
GN bac pour fours à convection	408
GN bol carré mélamine	154, 156, 158, 203, 205, 236, 240-241
GN Chafing Dish	382, 385-386, 389-393
GN cloche	20-21, 32, 174, 190, 354, 364-365, 374, 411, 530-532
GN corbeille	19, 374
GN corbeille métal	374
GN corbeille polypropylène	19, 354, 356, 361-364
GN couvercle	404-407, 410
GN égouttoir	405-406
GN grille	408
GN planche de service	53
GN plat ardoise naturelle	23-24, 49-50
GN plateau	18, 24, 29, 33-34, 60-61, 160-161, 166-167, 176, 178, 181-182, 185, 187, 190, 193, 200, 204, 208, 211, 214, 218-219, 224, 232, 236, 239, 243, 248-249, 336, 409
GN plateau acier inox	18, 29, 239
GN plateau mélamine	18, 24, 60-61, 161, 166-167, 176, 178, 181-182, 185, 187, 190, 193, 200, 204, 208, 211, 214, 218-219, 224, 232, 236, 239, 243, 248-249
GN plateau party	40-41
GN présentoir buffet	173, 200
GN support buffet	120
gobelet	437-442
gobelet à apéritif	272-275
gobelets	89-93, 436
gravier thermique	400
H	
housse isotherme	434
J	
jeu de cuillère à mesure	500

L	
louche	412-415, 487-490, 495
louche de service	492
M	
mandoline	513
marmite de buffet	391, 394-396
mesure jigger	445-447
Moscow Mule gobelet	437-439
moule à boule ronde simple	503
moule à glaçons en boules	455
moule à pizza	527
moules à flan	515
moulin à épices	314-319
moulin à poivre	314-319, 322
moulin à sel	314-319, 322, 512
multibox	140
O	
organisateur „bar caddy“	459
P	
pailles	457
panier à œufs	372
papier alimentaire	53, 269, 275
pare-haleine	59, 119
peleur	503
pelle à farine	517
pelle à gâteau	493, 495
pelle à glaçons	455
pelle à pizza	509, 517
petits chevalets de buffet	308, 310, 312
pichet	82-83, 85, 102-103, 435, 467-468, 514
pichet à café	102-103, 468
pichet à eau ou lait	85, 333, 467-469
pichet à jus de fruit	82-83
pichet gradué	514
pichet rafraîchisseur	81
piéd pour seau à champagne / vin	428
pilon muddler	450
pince	456, 487, 496-500
pince à dresser	456, 497
pince à homard	510
pince presse citron	470
pinceau pâtissier	518
pique-bons	521
planche à découper	18, 128, 129, 379, 451
planche à découper buffet	58-59
planche de service	53-57, 284-287, 341, 475
plaque à induction	383-384, 386-388, 398
plaque à pâtisserie	408, 516
plat à gâteau acier inox	38, 47, 290
plat à gâteau bois	45, 117, 293
plat à gâteau mélamine	46, 48, 183, 216, 256-257, 291-292
plat à sauter	296
plat ardoise naturelle	23-24, 39, 49-52, 54, 118-119, 286, 288-289, 319, 475
plat ardoise naturelle	23-24, 50-51, 288-289
plat de service	29, 400
plat pour la table	35, 270-271, 275, 525-526
plateau	18, 38, 42-44, 62-63, 269, 313, 357, 409, 423, 472-477, 516
plateau bois	63-64, 162, 165, 336, 475-476
plateau buffet froid	70, 72
plateau couvercle inox	18, 29-39, 42-44, 269, 313, 471-473, 477, 516
plateau feuille mélamine	195, 221, 250-251

plateau mélamine	18, 24, 43, 60-62, 128, 160-161, 165-167, 176-178, 181-183, 185, 187, 190, 192, 193, 199-202, 204, 205, 207-211, 213-221, 223-225, 230-233, 236-241, 243-245, 248-249, 251, 258, 265, 319, 379, 472, 474
plateau party	40-41
plateau self-service et snacks	64, 423, 476
plateau sous-verre acier inox	298
plateau sushi mélamine	180-181, 185, 192, 207, 221, 223, 225, 230
plateau verre	60, 109, 110
plateaux réfrigérés	17, 71, 73
plucheur droitier/gaucher	504
pochette couverts	351
poêle à frire forgée	526
poêle en fonte	270-271, 525
pompe à sauce	524
pompe à vide pour le vin	463
pont de buffet	111
porcelaine	383, 388
porte condiments et sauces	329
porte verres à bière	62, 435, 474
porte-addition	313, 477
porte-bols	136-137
porte-bougies anti-vent	345
porte-bouteilles	435
porte-cartes	305-312
porte-clés avec câble à enroulement	463
porte-étiquettes à pince	305-310, 312
porte-sachets de sucre	469
porte-serviettes	149-151
pose-cuillère	259, 400
pot à épices	320-322, 512
pot à sauce acier inox	65-66
pot à sauce mélamine	65-66
pot en verre avec couvercle	138-139, 519-520
pot verseur universel	332, 465-466
poubelle à pédale	483
poubelle de table	145-148, 302-304
présentoir	40, 108, 347
présentoir à assiettes	114-116, 118-120, 282
présentoir à gâteaux	38, 45-48, 117, 183, 216, 256-257, 290-293
présentoir à sandwiches	127
présentoir buffet	15, 22-24, 35, 74-75, 104-107, 109-110, 112, 121, 126, 131, 199, 366,
présentoir buffet acier inox	107, 173, 200, 377
présentoir buffet bois	15, 21, 104, 106
présentoir buffet chromé	35, 105-107, 126, 173, 200
présentoir buffet de froid	17, 19, 25, 61, 69, 74-75
présentoir buffet en escalier	122-125
présentoir pour le buffet	32, 39, 69
presse citron	452, 518
R	
rack porte-verres	435
rack pour planches à découper	522
rafraîchisseur	460
rafraîchisseur de bouteilles	28, 426, 429-434, 437, 460
rafraîchisseur de caviar	42, 294
ramasse-miettes	147, 313, 477
ramequin	254-255
réchaud à beurre et sauce	294
réceptacle bain-marie	513
réceptacle de table	146-148

résistance	94, 397, 398-399
S	
saucière	295
seau à champagne	430-431
seau à glaçons	19, 84, 454
seau à glaçons isothermique	426, 453
seau à vin ou champagne	426-429, 431-432
service à parmesan	328
set apéritif	248, 323-329
set cloche à fromage	39, 59
set de table	347-350
set thermo	75
shaker	443-444
snackbox	268, 275
sonnette	483
soucoupes ardoise naturelle	51, 289, 319
soucoupes liège, bois	89-92, 526
spatule	413-415, 486, 489-491, 494, 506-507
spatule coudée spéciale grill	508
spatule pâtissière	506
stylo	312
sucrier	331-333, 465-467, 470
superbox	22-24
support	199, 329, 428, 522
support à bretzel ou à saucissons	59, 119
support à cornets	522
support multiple acier inox	135-136
support pour brochettes	294
T	
tamis	449, 451, 511-513
tapis antidérapant	166
tapis de bar	458
tapis égouttoir	458
tasse à café	259
tasse mélamine	259
théière ASIA	85, 467
tire-bouchons	464
tour de service	134
truelle de service	268, 471
V	
vase soliflor	346
verre mélangeur	461
verres à moutarde	325
verres gourmet	281
verseurs continus	462
vitrine de buffet	67-68, 70-73
W	
Weck-bouteilles	280-282



BREAD BROT PARISIENNE MICHE



Buffet & Display

Tablets
Karaffen
Dispenser
Buffetständer
Isolierkannen

bandejas
jarras
dispensadores
soportes para buffet
jarras termo

trays
carafes
dispensers
buffet stands
vacuum jugs

plateaux
carafes
distributeurs
présentoirs buffet
bouteilles isotherme

ELEMENT



Bekannt aus dem Bereich der Inneneinrichtung, lässt sich Beton nun auch im Buffetbereich stilvoll einsetzen. ELEMENT bietet drei unterschiedliche Präsentationsschalen, die sehr ansprechend in jede rustikale, natürliche aber auch urbane Buffetlandschaft integriert werden kann.

Known from the interior design sector, concrete can now also be used stylishly in the buffet area. ELEMENT offers three different presentation bowls, which can be very attractively integrated into any rustic, natural but also urban buffet landscape.

Conocido del sector de diseño interior, ahora el homigón también puede ser utilizado en el área del buffet. ELEMENT ofrece tres cuencos de presentación diferentes, que pueden ser integrados atractivamente en cualquier paisaje de buffet rústico, natural, pero también urbano.

Connu dans le domaine du design d'intérieur, le béton peut désormais être utilisé avec élégance dans la zone du buffet. ELEMENT offre trois bols de présentation différents, qui peuvent être intégré très attrayante dans n'importe quel paysage de buffet rustique, naturel, mais aussi urbain.





Schale „ELEMENT“

bowl
cuenco
bol



	Ø cm	↑ cm	ltr.
30000	22	6,0 / 10,5	1,1



Schale „ELEMENT“

bowl
cuenco
bol



	Ø cm	↑ cm	ltr.
30001	26	7,5 / 13,0	1,7



Schale „ELEMENT“

bowl
cuenco
bol



	Ø cm	↑ cm	ltr.
30002	29,5	8,5 / 14,5	2,5



Buffetständer

buffet stand
expositor de buffet
présentoir buffet



Akazienholz
acacia wood
madera de acacia
bois d'acacia

	Ø cm	↑ cm
33255	15	10



Buffetständer

buffet stand
expositor de buffet
présentoir buffet



Akazienholz
acacia wood
madera de acacia
bois d'acacia

	Ø cm	↑ cm
33256	25	15

COCONUT



Schale „COCONUT“

bowl
cuenco
bol



	Ø cm	↑ cm	ltr.
30020	18	9,5	1



Schale „COCONUT“

bowl
cuenco
bol



	Ø cm	↑ cm	ltr.
30021	23	12,5	2,2



FRAMES



Die reduzierte, archetypische Formsprache von FRAMES nimmt sich elegant zurück und lässt damit viel Raum für die Inszenierung der Buffet-Speisen. Ein scheinbarer Widerspruch löst sich auf: das Design ist zeitgemäß und zeitlos zugleich.

Design in detail – The classic minimalist visual style of FRAMES is elegantly understated, leaving plenty of potential for creating appealing buffet arrangements. Its design transcends what at first seems to be an irreconcilable paradox, being at once both timeless and highly contemporary.



Kühltablets SET 1 „FRAMES“

cooling plates
bandejas refrigeradas
plateaux réfrigérés



GN 1/1 Basiselement, GN 1/1 Edelfstahl Tablett 18/10, Kühlakku
GN 1/1 base element, GN 1/1 stainless steel platter 18/10, cooler
elemento básico GN 1/1, bandeja GN 1/1 de acero inoxidable 18/10, acumulador de frío
élément de base GN 1/1, plateau GN 1/1 inox 18/10, accumulateur de froid

	cm	↑ cm	GN	Farbe / Colour	
12940	53 x 32,5	8,5	1/1		stainless steel
14940	53 x 32,5	8,5	1/1		wenge wood
13940	53 x 32,5	8,5	1/1		ahorn wood



Kühltablets SET 2 „FRAMES“

cooling plates
bandejas refrigeradas
plateaux réfrigérés



GN 1/1 Basiselement, GN 1/1 Edelfstahl Tablett 18/10, Rolltop-Haube, Kühlakku
GN 1/1 base element, GN 1/1 stainless steel platter, rolltop cover, cooler
elemento básico GN 1/1, bandeja GN 1/1 de acero inoxidable 18/10, campana rolltop, acumulador de frío
élément de base GN 1/1, plateau GN 1/1 inox 18/10, cloche rolltop, accumulateur de froid

	cm	↑ cm	GN	Farbe / Colour	
12941	53 x 32,5	27,5	1/1		stainless steel
14941	53 x 32,5	27,5	1/1		wenge wood
13941	53 x 32,5	27,5	1/1		ahorn wood

Buffet & Display

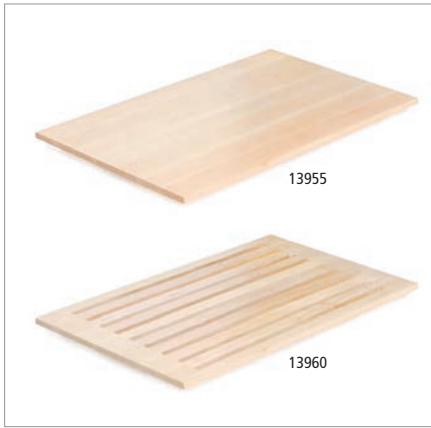

Schneidebrett „FRAMES“

chopping Board
tabla para cortar
planche à découper



Ahorn, massiv
ahorn wood, solid
madera de arce, masivo
bois d'érable, massif

	cm		
13955	53 x 32,5	1/1	
13960	53 x 32,5	1/1	gerillt



Schneidebrett „FRAMES“

chopping Board
tabla para cortar
planche à découper



	cm	GN
17910	53 x 32,5	1/1



GN Edelstahl Tablett „FRAMES“

GN stainless steel platter
GN bandeja acero inoxidable
GN plateau acier inox



	cm		GN
11119	53,0 x 32,5		1/1
11118	32,5 x 26,5		1/2



GN Tablett „FRAMES“

GN tray
GN bandeja
GN plateau



	cm	↑ cm	GN
84046	53,0 x 32,5	2	1/1
84047	32,5 x 26,5	2	1/2
84048	32,5 x 17,6	2	1/3



GN Tablett „FRAMES“

GN tray
GN bandeja
GN plateau



	cm	↑ cm	GN
82355	53,0 x 32,5	2	1/1
82356	32,5 x 26,5	2	1/2
82357	32,5 x 17,6	2	1/3



GN Polystyrolwanne „FRAMES“

GN polystyrene tray
GN bandeja poliestireno
GN plateau polystyrène



	cm	GN
17922	53 x 30	1/1



Korb „GN LINE“

GN basket
GN cesta
GN corbeille



stabile Ausführung mit Edelstahldraht im Rand zur Stabilisierung
very solid with stainless steel wire frame to stabilize the basket
muy resistente con refuerzo de alambre inox
très résistante avec son fil de renfort inox

	cm	↑ cm	GN
40291	53,0 x 32,5	6,5	1/1
40290	32,5 x 26,5	6,5	1/2
40293	53,0 x 32,5	10,0	1/1
40292	32,5 x 26,5	10,0	1/2



Buffetkorb

buffet basket
cesta de buffet
corbeille de buffet



Polyrattan, mit Haubenschiene (ohne Haube)
polyrattan, with frame to fix the (without cover)
polyrattan, con fijación para campana (sin campana)
polyrattan, avec fixation pour la cloche (sans cloche)

	Ø cm	↑ cm
40295	40	12,5



GN Basket

GN basket
cesta GN
corbeille GN



Polyrattan, mit Haubenschiene (ohne Haube)
polyrattan, with frame to fix the (without cover)
polyrattan, con fijación para campana (sin campana)
polyrattan, avec fixation pour la cloche (sans cloche)

	cm	↑ cm
40294	56,5 x 36,0	10,0



Rolltop-Haube

rolltop cover
campana abatible
cloche basculante



	Ø cm	↑ cm
18389	38	20



Eisbox „FRAMES“

ice box
bandeja para hielo para buffet
caisse à glaçons pour le buffet



3-teilig: 1 Basiselement Wenge + 1 Polystyrolwanne + 1 Tropfgitter

3 pcs. set: 1 box wenge + 1 plastic deep tray + 1 drainer plate

set de 3: 1 cajón color wengué, 1 cubeta plástico, 1 rejilla

set de 3: 1 caisson couleur wengé, 1 bac plastique, 1 plaque perforée

	cm	↑ cm	GN	Farbe / Colour
14970	53 x 32,5	12,5	1/1	

Buffet & Display



GN 1/1 Rolltop-Haube
 GN 1/1 rolltop cover
 GN 1/1 campana abatible
 GN 1/1 cloche basculante



	cm	↑ cm	GN
11018	53 x 32,5	17	1/1



Besteck- / Universal-Box, 2-teilig „FRAMES“
 cutlery tray, 2 pcs.
 cubertero o cajón multi-usos, 2pz.
 caisson à couverts ou multi-usages



Buche massiv, Wenge, 4 Fächer, inklusive herausnehmbaren Einsatz
 wood wenge, 4 compartments
 madera de haya maciza, color wengué, 4 compartimentos, separadores removibles
 hêtre massif, couleur wengé, 4 compartiments, séparateurs amovibles

	cm	↑ cm	GN	Farbe / Colour
14956	53 x 32,5	11	1/1	■

Einsatz für GN 1/1 „FRAMES“ / insert for GN1/1 „FRAMES“ / interior para GN1/1 „FRAMES“ / insert pour GN1/1 „FRAMES“

	cm	↑ cm	Farbe / Colour
14954	48,5 x 28	8	■



Gestell für GN 1/1 „FRAMES“
 serving stand
 cubertero o cajón multi-usos
 caisson à couverts ou multi-usages



Buche massiv, Wenge
 wood, wenge
 madera de haya maciza, wengué
 hêtre massif, wengé

	cm	↑ cm	Farbe / Colour
14953	57,5 x 27,5	22	■



NEW ACACIA



Buffetständer „ACACIA“

buffet stand
soporte para buffet
présentoir buffet



Akazienholz geölt / acacia wood oiled / madera de acacia aceitada / bois d'acacia huilé

	Ø cm	↑ cm
15620	20,0	10,5
15621	30,5	15,0
15622	30,5	20,0

Frischhalte- Haube / cover / campana / cloche



	Ø cm	↑ cm	fits to
06520	30	22	15621, 15622

Frischhalte- Haube / cover / campana / cloche



	Ø cm	↑ cm	fits to
06512	30	11,5	15621, 15622



Buffetständer „ACACIA“

buffet stand
soporte para buffet
présentoir buffet



Akazienholz geölt / acacia wood oiled / madera de acacia aceitada / bois d'acacia huilé

	cm	↑ cm	GN
15623	53 x 16,2	20	2/4

GN Abdeckhaube / GN cover / GN cubierta/ GN cloche



	cm	↑ cm	* mm	GN
11044	53 x 16,2	10,5	3	2/4

SUPERBOX

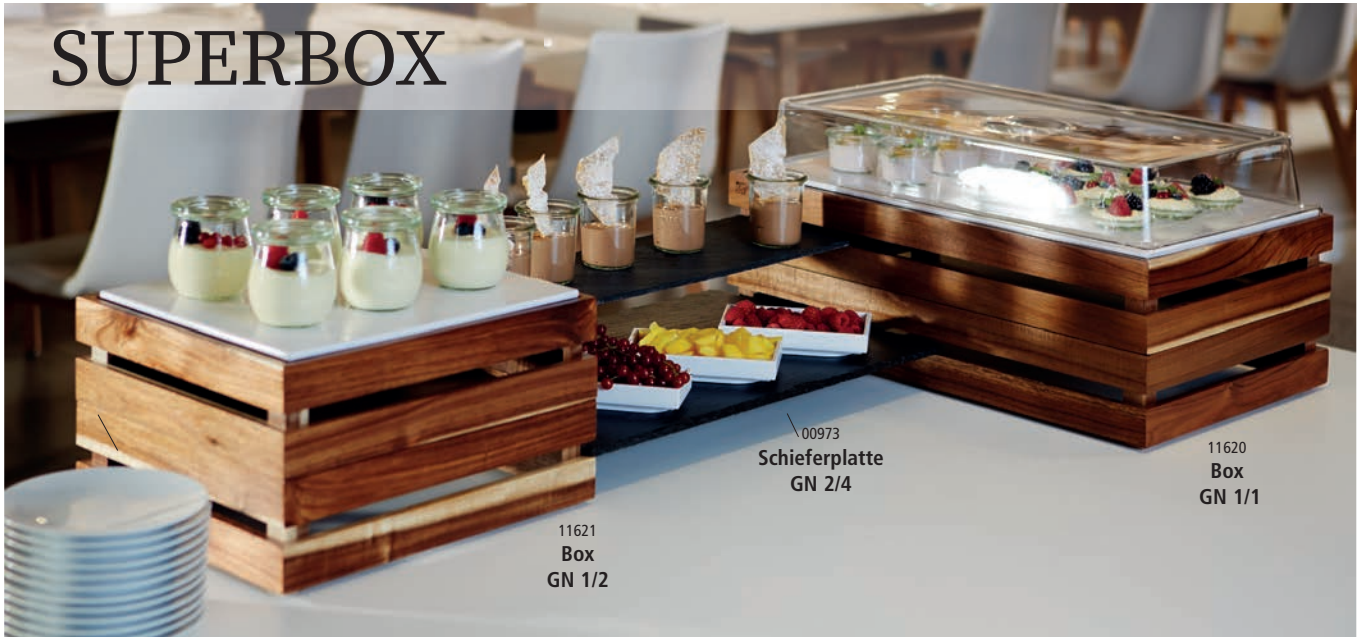

Die stapelbaren Wendeboxen lassen sich rutschfest stapeln und mit flachen GN Platten verbinden und einzeln nutzen. Individuell können Buffetlandschaften gebaut werden.

The stackable and non-slip reversible boxes can be connected to flat GN trays and can also be used individually. Different and individual buffet sceneries can be built up.

Las cajas girable y apilables son antideslizantes y se pueden conectar con bandejas planas GN o utilizar individualmente. Se pueden construir diferentes paisajes de buffet muy individuales.

Les boîtes de tournage empilables sont antiglissantes et peuvent être connectées avec des plateaux plats GN ou utilisées individuellement. Des paysages de buffet très personnalisés peuvent être construits.



GN 1/1 „SUPERBOX“

Akazienholz / acacia wood / madera de acacia / bois d'acacia

	cm	↑ cm	Farbe / Colour
11620	55,5 x 35	10,5	
11626	55,5 x 35	10,5	



GN 2/4 „SUPERBOX“

Akazienholz / acacia wood / madera de acacia / bois d'acacia

	cm	↑ cm	Farbe / Colour
11623	55,5 x 18,5	10,5	
11629	55,5 x 18,5	10,5	



GN 1/2 „SUPERBOX“

Akazienholz / acacia wood / madera de acacia / bois d'acacia

	cm	↑ cm	Farbe / Colour
11621	35 x 29	10,5	
11627	35 x 29	10,5	



GN 1/4 „SUPERBOX“

Akazienholz / acacia wood / madera de acacia / bois d'acacia

	cm	↑ cm	Farbe / Colour
11622	29 x 18,5	10,5	
11628	29 x 18,5	10,5	





GN „SUPERBOX VINTAGE“



Akazienholz
 acacia wood
 mader de acacia
 bois d'acacia

	cm	↑ cm	GN	Farbe / Colour
11715	55,5 x 35,0	10,5	GN 1/1	■
11716	35,0 x 29,0	10,5	GN 1/2	■
11717	29,0 x 18,5	10,5	GN 1/4	■
11718	55,0 x 18,5	10,5	GN 2/4	■



Präsentationsmöglichkeit
 presentation example



GN Naturschieferplatten



GN natural slate tray
 GN bandeja de pizarra natural
 GN plat ardoise naturelle

	cm	GN
00990	53,0 x 32,5	1/1
00991	32,5 x 26,5	1/2
00993	26,5 x 16,2	1/4
00973	53,0 x 16,2	2/4



GN Einsatz „SUPERBOX“



GN insert
 GN bandeja
 GN bac supérieur

	cm	↑ cm	GN	fits to
11616	53,0 x 32,5	8,5	GN 1/1	11620, 11626, 11700, 11715
11617	32,5 x 26,5	8,5	GN 1/2	11621, 11627, 11701, 11716



Buffet & Display



GN „SUPERBOX VINTAGE“



Leichtes Holz, Tannenholz
fir wood
madera de abeto
bois sapin

	cm	↑ cm	GN
11700	55,5 x 35,0	10,5	GN 1/1
11701	35,0 x 29,0	10,5	GN 1/2
11702	29,0 x 18,5	10,5	GN 1/4
11703	55,0 x 18,5	10,5	GN 2/4



GN Tablett „ZERO“



GN tray
GN bandeja
GN plateau

	cm	↑ cm	GN	Farbe / Colour
84185	53,0 x 32,5	1,5	1/1	White
84195	53,0 x 32,5	1,5	1/1	Black
84186	32,5 x 26,5	1,5	1/2	White
84196	32,5 x 26,5	1,5	1/2	Black
84188	26,5 x 16,2	1,5	1/4	White
84198	26,5 x 16,2	1,5	1/4	Black
84189	53,0 x 16,2	1,5	2/4	White
84199	53,0 x 16,2	1,5	2/4	Black



mit Antirutschfüßchen
with non-slip feet



GN Naturschieferplatten



GN natural slate tray
GN bandeja de pizarra natural
GN plat ardoise naturelle

	cm	GN
00990	53,0 x 32,5	1/1
00991	32,5 x 26,5	1/2
00993	26,5 x 16,2	1/4
00973	53,0 x 16,2	2/4



Mit hohem Anspruch an Design und Funktionalität haben wir das Buffet-System „Bridge“ für Sie entwickelt. Die in den Holzoberflächen Ahorn und Wenge erhältlichen Artikel sind in ihren Höhen und ihren Volumina optimal aufeinander abgestimmt und gewährleisten einen einfachen und sicheren Umgang in Ihrem Gastronomiealltag.

The collection "Bridge" is bringing perfectly coordinated components for an uncomplicated and organized buffet system, finalizing in an unique buffet scenery. All pieces combine perfectly with one another in their variations of sizes and volumes. The wooden items are available in 2 colors, maple or wenge. A simple and safe handling is guaranteed.

Una colección universal para un buffet único: un Sistema funcional y fácil de componer, asociado a la elegancia de su exclusive diseño. Los elementos se combinan a la perfección entre variaciones de Alturas y volúmenes, realizando sus propuestas y composiciones culinarias y modelando el paisaje del buffet. Las piezas están disponibles en 2 colores, wengué o arce. Manejo sencillo y seguro.

Une collection universelle pour une présentation unique de votre buffet: fonctionnel et facile à composer, ce système est à la fois pratique, simple et spectaculaire par son élégant design. Les différents éléments se marient à la perfection pour construire sans difficulté différentes compositions, variant les hauteurs et les volumes et mettant en valeur vos créations culinaires. Les pièces sont disponibles en deux couleurs, bois wengué ou érable.



Kühlbox „BRIDGE“
refrigerated buffet display
set de buffet refrigerado
présentoir buffet froid



Set bestehend aus: 1 Gestell aus Ahorn oder Wenge, 1 Behälter aus Kunststoff, 1 GN1/1 Tablett aus Melamin, 1 Kühlakku, 1 Rolltophaube (fix montiert)
set consists of: 1 base element maple or wenge, 1 plastic insert black, 1 GN1/1 tray melamine, 1 cooler, 1 cover (fixed)

set compuesto por: 1 soporte de madera arce o wengué, 1 cubeta de plástico, 1 bandeja de melamina GN 1/1, 1 acumulador de frío, 1 campana rolltop (fija)

set composé de: 1 support en bois érable ou wengué, 1 bac plastique, 1 plat en mélamine GN 1/1, 1 accumulateur de froid, 1 cloche rolltop (fixe)

	cm	↑ cm	Farbe / Colour	
13990	63,5 x 42,5	31		ahorn wood
14990	63,5 x 42,5	31		wenge wood

Buffet & Display



Kühlschale „BRIDGE“

cooling bowl
bol refrigerado
bol réfrigéré



4-teilig: 1 Gestell aus Ahorn oder Wenge, 1 Behälter aus Edelstahl,
1 Schale aus Melamin (Ø 14 cm o. 23 cm), 1 Kühlakku

4 pcs.: 1 base element maple or wenge, 1 bowl stainless steel,
1 bowl melamine (Ø 14 o. 23 cm), 1 cooler

set de 4: 1 soporte de madera arce o wengué, 1 cuenco
de acero inoxidable, 1 cuenco de melamina (ø 14 cm o 23 cm), 1 acumulador de frío

set de 4: 1 support en bois érable ou wengé, 1 bol en acier inox, 1 bol en mélamine
(ø 14 cm ou 23 cm), 1 accumulateur de froid

	cm	↑ cm	ltr.	Farbe / Colour
13980	18,5 x 18,5	10	0,5	
13981	27,5 x 27,5	14	2,5	

	cm	↑ cm	ltr.	Farbe / Colour
14980	18,5 x 18,5	10	0,5	
14981	27,5 x 27,5	14	2,5	



Edelstahlschale „BRIDGE“

stainless steel bowl
cuenco acero inoxidable
bol acier inoxydable



	Ø cm	↑ cm
30050	14	8,5
30052	23	13,5



Schale „CASUAL MAXI“

bowl
cuenco
bol



	Ø cm	↑ cm	ltr.	Farbe / Colour
83700	14	6,5	0,5	
83702	23	10,5	2,5	

	Ø cm	↑ cm	ltr.	Farbe / Colour
83701	14	6,5	0,5	
83703	23	10,5	2,5	



Frischhaltedeckel

airtight cover
tapa hermética
couvercle hermétique



	Ø cm
10890	14
10887	23

Kühlakku / cooler / acumulador de frío / accumulateur de froid

	Ø cm	↑ cm
10661	10,5	2,5
10777	15,5	2,5



Cerealispender „BRIDGE“

cereal dispenser
dispensador de cereales
distributeur de céréales



Behälter herausnehmbar, „Feierabend-Deckel“ für das aromadichte Lagern, portionieren durch einfaches Drehen

removable canister, special lid to keep the cereals fresh, easy to use, rotate the button to get the muesli

contenedor movable, tapa especial para mantener los cereales frescos, fácil de usar, se gira el pomo para servir los cereales

réceptif amovible, couvercle spécial pour conserver les céréales, usage facile en tournant le bouton

	cm	↑ cm	ltr.	Farbe / Colour	
13987	21 x 20	55,5	4,5		Ahorn / maple



Saftdispenser „BRIDGE“

juice dispenser
dispensador de zumo
distributeur à jus



Kühlung durch 2 Kühlakkus von oben und unten

cooling with 2 cooling elements from the top and base

2 acum. de frío 1 en la base y 1 en la tapa

2 plaques de froid 1 dans le couvercle, 1 dans le socle

	cm	↑ cm	ltr.	Farbe / Colour	
10870	31,0 x 20	42	4		Ahorn / maple
10871	35,5 x 22	50	6		Ahorn / maple



Besteckbehälter „BRIDGE“

cutlery organizer
cajón para cubiertos
bac à couverts



2-teiliges Set: 1 Gestell, 1 Besteckbehälter (Nr. 11955), herausnehmbar

2 pcs set: 1 base element, 1 removable plastic container (item 11955)

set de 2 piezas: 1 soporte + 1 cubeta extraíble 4 compartimentos de plástico (ref. 11955)

set de 2 pcs: 1 support + 1 bac plastique amovible à 4 compartiments (réf. 11955)

	cm	↑ cm	Farbe / Colour	
13995	57,5 x 37	12		Ahorn / maple



Konferenzkühler „BRIDGE“

bottle cooler
enfriador
refraîchisseur



2-teiliges Set, bestehend aus: 1 Gestell, 1 Behälter aus Edelstahl (doppelwandig)

2 pcs set: 1 base element, 1 bowl stainless steel (double-wall)

set de 2 piezas: 1 soporte, champanera inox de doble pared

set de 2 pcs: 1 support, seau inox double paroi

	cm	↑ cm	Farbe / Colour	
13985	35 x 35	19		Ahorn / maple

Buffet & Display



Cerealienspender „BRIDGE“

cereal dispenser
dispensador de cereales
distributeur de céréales



Behälter herausnehmbar, „Feierabend-Deckel“ für das aromadichte Lagern, portionieren durch einfaches Drehen

removable canister, special lid to keep the cereals fresh, easy to use, rotate the button to get the muesli

contenedor movable, tapa especial para mantener los cereales frescos, fácil de usar, se gira el pomo para servir los cereales

réceptif amovible, couvercle spécial pour conserver les céréales, usage facile en tournant le bouton

	cm	↑ cm	ltr.	Farbe / Colour	
14987	21 x 20	55,5	4,5		Wenge / wenge

inkl. 3 Magnetschilder:
ORANGE, APPLE, GRAPEFRUIT



6 ltr.

10873

Saftdispenser „BRIDGE“

juice dispenser
dispensador de zumo
distributeur à jus



Kühlung durch 2 Kühllakkus von oben und unten

cooling with 2 cooling elements from the top and base

2 acum. de frío 1 en la base y 1 en la tapa

2 plaques de froid 1 dans le couvercle, 1 dans le socle

	cm	↑ cm	ltr.	Farbe / Colour	
10872	31,0 x 20	42	4		Wenge / wenge
10873	35,5 x 22	50	6		Wenge / wenge



Besteckbehälter „BRIDGE“

cutlery organizer
cajón para cubiertos
bac à couverts



2 teiliges Set: 1 Gestell, 1 Besteckbehälter (Nr. 11955), herausnehmbar

2 pcs set: 1 base element, 1 removable plastic container (item 11955)

set de 2: 1 soporte, 1 cajón para cubiertos (ref. 11955), extraíble

set de 2: 1 support, 1 bac à couverts (réf. 11955), amovible

	cm	↑ cm	Farbe / Colour	
14995	57,7 x 37	12		Wenge / wenge



Flaschenkühler „BRIDGE“

bottle cooler
enfriador
refraîchisseur



2-teiliges Set, bestehend aus: 1 Gestell, 1 Behälter aus Edelstahl (doppelwandig)

2 pcs set: 1 base element, 1 bowl stainless steel (double-wall)

set de 2: 1 soporte, 1 cuenco de acero inoxidable (doble pared)

set de 2: 1 support, 1 bol en acier inox (double paroid)

	cm	↑ cm	Farbe / Colour	
14985	35 x 35	19		Wenge / wenge

PROFI LINE

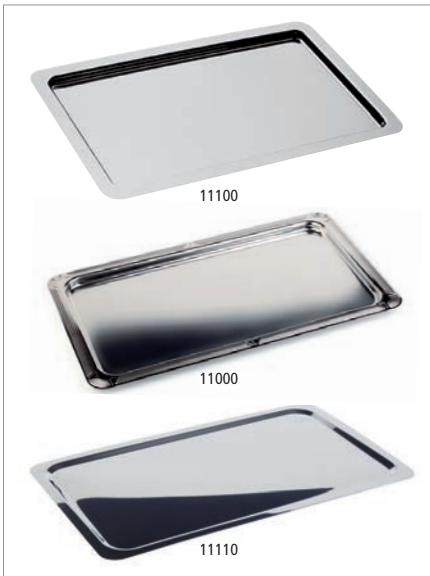

GN Edelstahl-Tablett „PROFI LINE“

GN tray
GN bandeja
GN plat empilable système catering



	cm	↑ cm	GN	
11100	53,0 x 32,5	1,5	1/1	mit glattem Rand / without decor-edge sin borde decorado / bords lisses
12100	32,5 x 26,5	1,5	1/2	mit glattem Rand / without decor-edge sin borde decorado / bords lisses
11000	53,0 x 32,5	1,5	1/1	mit Dekor-Rand / with decor-edge con borde decorado / bords avec relief
12000	32,5 x 26,5	1,5	1/2	mit Dekor-Rand / with decor-edge con borde decorado / bords avec relief
11110	53,0 x 32,5	1,0	1/1	glatter schmaler Rand / smooth narrow edge / borde estrecho liso / bord étroit lisse



Fleisch- und Gemüseplatte „PROFI LINE“

tray
fuente de servicio
plat de service

Dekorrand hochglanzpoliert
decor edge mirror polished finish
borde decorado pulido efecto espejo
contour relief avec effet miroir



	Ø cm	↑ cm
11032	32	2,6
11038	38	2,6
11048	48	2,6



Fleisch- und Gemüseplatte „PROFI LINE“

tray
fuente de servicio
plat de service

Dekorrand hochglanzpoliert
decor edge mirror polished finish
borde decorado pulido efecto espejo
contour relief avec effet miroir



	cm	↑ cm
11023	50 x 36	2,6
11024	60 x 41	2,6
11025	70 x 46	2,6

Buffet & Display



GN Edelstahl-Behälter „PROFI LINE“

GN pan
GN cubeta
GN bac



	cm	↑ cm	GN	litr.
11020	53,0 x 32,5	2,0	1/1	1,7
11040	53,0 x 32,5	4,0	1/1	3,4
11065	53,0 x 32,5	6,5	1/1	7,0
12040	32,5 x 26,5	4,0	1/2	2,0
12065	32,5 x 26,5	6,5	1/2	3,3



GN 1/1 System-Tablett „PROFI LINE“

GN 1/1 tray
GN 1/1 bandeja
GN 1/1 plateau



Dekorrand hochglanzpoliert, massive Griffe verchromt, inkl. fest verschraubten Distanzstücken, Nutzhöhe 4 cm
decor edge mirror polished finish, chrome plated handles, incl. mounted 4 cm distance pillars

borde decorado pulido brillante, asas cromadas, incl. distanciadores atornillados, con profundidad efectiva de 4 cm

bord avec reliefs poli miroir, poignées chromées, incl. distance bien fixée avec hauteur utile de 4 cm

	cm	GN
11300	53 x 32,5	1/1



GN 1/1 System-Tablett „PROFI LINE“

GN 1/1 tray
GN 1/1 bandeja
GN 1/1 plateau



Rand hochglanzpoliert, massive Bügelgriffe vergoldet, inkl. fest verschraubten Distanzstücken, Nutzhöhe 4 cm
mirror polished finish edge, gold plated handles, stackable approx. 4 cm

borde pulido brillante, asas doradas, incl. distanciadores atornillados, con profundidad efectiva de 4 cm

bord poli miroir, poignées dorées, incl. distance bien fixée avec hauteur utile de 4 cm

	cm	GN
11290	53 x 32,5	1/1



GN 1/1 System-Tablett „BUFFET-STAR“

GN 1/1 tray
GN 1/1 bandeja
GN 1/1 plateau



Rand hochglanzpoliert, inkl. fest verschraubten Griffen inkl. Distanzstücken, Nutzhöhe 4 cm
mirror polished finish edge, incl. screwed handles incl. distance pillars, 4 cm distance

borde pulido brillante, incl. asas atornillables, incl. distanciadores con profundidad efectiva de 4 cm

bord poli miroir, incl. poignées à visser, incl. distance avec hauteur utile de 4 cm

	cm	GN	
11150	53 x 32,5	1/1	mit verchromten Griffen / with chrome plated handles / con asas cromadas / avec poignées chromées
11155	53 x 32,5	1/1	mit vergoldeten Griffen / with gold plated handles / con asas doradas / avec poignées dorées



System-Tablett „BUFFET-STAR“

system tray
bandeja del sistema
plat empilable système catering



Rand hochglanzpoliert, inkl. fest verschraubten Griffen inkl. Distanzstücken, Nutzhöhe 4 cm
mirror polished finish edge, incl. screwed handles incl. distance pillars, 4 cm distance
borde pulido efecto espejo, incluye asas atornillables, distanciadores a 4 cm
contour effet miroir, poignées à visser, distance approx. 4 cm

	Ø cm	
11160	48	mit verchromten Griffen / with chrome handles
11165	48	mit vergoldeten Griffen / gold plated handles

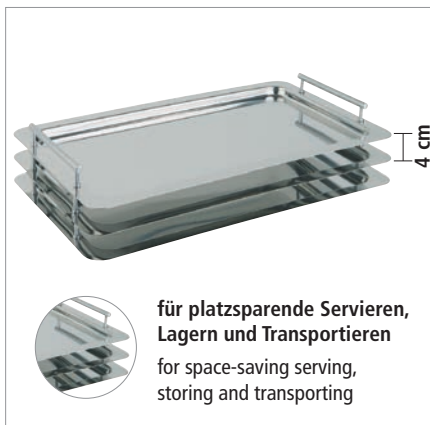

GN 1/1 System-Tablett „CLASSIC“

GN tray
GN bandeja
GN plat empilable système catering



Rand hochglanzpoliert, mit fest verschraubten Griffen inkl. Distanzstücken, Nutzhöhe 4 cm
mirror polished finish edge, incl. screwed handles incl. distance pillars, 4 cm distance
borde pulido efecto espejo, incluye asas atornillables, distanciadores a 4 cm
contour effet miroir, poignées à visser, distance approx. 4 cm

	cm	GN
11295	53 x 32,5	1/1



Tablett „SWING“

tray
bandeja
plateau



Rand matt poliert, innen hochglanzpoliert
satin polished finish edge, inside mirror polished finish
borde pulido efecto satinado, interior pulido efecto espejo
contour effet mat, intérieur poli miroir

	cm	↑ cm	GN
01415	28,5 x 20,0	1	
01416	32,5 x 32,5	1	
01420	53,0 x 32,5	1	1/1



Tablett „SUNDAY“

tray
bandeja
plateau



hochglanzpoliert
mirror polished finish
acabado espejo pulido
effet brillant

	cm	↑ cm	GN
11210	32,5 x 26,5	2	1/2
11220	53,0 x 32,5	2	1/1

Buffet & Display



GN 1/1 Buffet-Set „CATERER“

GN 1/1 buffet set
GN 1/1 set de bufé
GN 1/1 set catering: plateau + cloche



2-teilig: Tablett + Haube, Tablett fixiert sich auf der Haube - kein Rutschen möglich
2 pcs. set: tray + cover, tray fixes itself on the cover and can not slip off
set de 2: bandeja + tapa, la bandeja encaja encima de la tapa para que no se deslice
set de 2: plateau GN 1/1 réf. + cloche spéciale empilement stable

	cm	↑ cm	GN
11195	53 x 32,5	10,5	1/1



GN 1/1 Buffet-Set „HOCHSTAPLER“

GN 1/1 buffet set
GN 1/1 set de bufé
GN 1/1 kit catering plateau + cloche



2-teilig: Tablett + Haube, Tablett fixiert sich auf der Haube - kein Rutschen möglich
2 pcs. set: tray + cover, tray fixes itself on the cover and can not slip off
set de 2: bandeja + tapa, la bandeja encaja encima de la tapa para que no se deslice
set de 2: plateau GN 1/1 réf. + cloche spéciale empilement stable

	cm	↑ cm	GN
11302	53 x 32,5	10,5	1/1



GN 1/1 Haube „HOCHSTAPLER“

GN 1/1 cover
GN 1/1 campana
GN 1/1 cloche



glasklarer Kunststoff, Tablett fixiert sich auf der Haube - kein Rutschen möglich, nahezu bruchfest

clear plastic, tray fixes itself on the cover and can not slip off, nearly unbreakable
plástico transparente, la bandeja se fija a la tapa para que no se deslice, muy resistente a la rotura

en plastique transparent, le plat se fixe sur le dessous de la cloche pour ne pas glisser, très résistant à la casse

	cm	↑ cm	fits to	GN
11305	53 x 32,5	9	11300, 11290, 11295	1/1



GN Abdeckhaube

GN cover
GN cubierta
GN cloche



	cm	↑ cm	✱ mm	GN
11041	32,5 x 26,5	9,5	3	1/2
11042	53,0 x 32,5	9,5	3	1/1
11043	32,5 x 17,6	10,5	3	1/3
11044	53,0 x 16,2	10,5	3	2/4



00382

Tablett „SCHÖNER ESSEN“

tray
bandeja
plateau



cm		
00383	35,0 x 24,0	
00382	42,0 x 31,0	
00381	50,0 x 36,0	
00384	63,5 x 44,5	
00385	60,0 x 40,0	
cm		
03824	42,0 x 31,0	leichte Ausführung 0,5 mm / extra light model 0,5 mm modelo extraligero 0,5 mm / qualité légère, ép. 0,5 mm
03814	50,0 x 36,0	leichte Ausführung 0,5 mm / extra light model 0,5 mm modelo extraligero 0,5 mm / qualité légère, ép. 0,5 mm



GN 1/1

GN 1/1 Tablett „SCHÖNER ESSEN“

GN tray
GN bandeja
GN plateau



cm	GN
00388	53,0 x 32,5 / 1/1



00081

Tablett „SCHÖNER ESSEN“

tray
bandeja
plateau



mit Dekorrand, Griffe Zinkdruckguss verchromt, genietet
with decor edge, handles zinc alloy chrome plated, riveted
borde decorado, asas fundición con zinc
bord décor, poignées en fonte zinguée

cm		
00082	52 x 31,0	
00081	60 x 36,0	
00084	75 x 44,5	



Tablett „SCHÖNER ESSEN“

tray
bandeja
plateau



cm		
00087	38 x 23	rechteckig, abgerundet / rectangular, rounded edge rectangular / rectangulaire



oval

Tablett „SCHÖNER ESSEN“

tray
bandeja
plateau



cm		
00089	50 x 39,5	

Buffet & Display



Tablett „SCHÖNER ESSEN“

tray
bandeja
plateau



	Ø cm	
00075	31	
00085	35	



Tablett mit Haube „SCHÖNER ESSEN“

tray with cover
bandeja con cubierta
plateau avec cloche



	cm	↑ cm
38202	42 x 31	8

Haube / cover / campana / cloche

	cm	↑ cm
08201	36,5 x 26,0	7,5



GN 1/1 Tablett „STAR“

GN tray
GN bandeja
GN plateau



Rand hochglanzpoliert mit Prägung
polished decor edge
borde pulido decorado
bords polis miroir, avec relief sur les petits côtés

	cm	GN
11115	53 x 32,5	1/1



griffig, keine Fingerabdrücke sichtbar, Randprägung auf kurzen Seiten
catchy, fingerprints are not visible, edge lettering on the short sides



GN 1/1 Buffet-Tablett „HALBMOND“

GN tray
GN bandeja
GN plat demi-lune



mit klassischem Linienpräggedekor, passend für Thermoboxen GN 1/1 und Thermoporte
with decor edge, usable in thermoboxes GN 1/1
con borde decorado, apto para cajas térmicas GN 1/1
bords avec relief, apte pour conteneurs GN 1/1

	cm	GN
11111	53 x 32,5	1/1



Edelstahl-Schale

bowl
bandeja ovalada inox
corbeille ovale inox



eingerollter Rand
rolled edge
borde redondeado
bord roulé

	cm	↑ cm
40110	26,5 x 18,5	4,0
40115	31,0 x 21,0	4,5



Tablett

tray
bandeja
plateau

mit gebördeltem, polierten Rand
rolled and mirror polished edge
borde redondeado acabado efecto espejo
bord rond, effet miroir



	Ø cm	↑ cm
01336	35	3



Buffetständer

buffet stand
soporte buffet
support buffet



	Ø cm	↑ cm	fits to
74207	20 - 25	19	01336



Ø 19 cm - Ø 28 cm - Ø 40 cm

Servierpfanne

pan
fuente para la mesa
plat pour la table

mit vergoldeten Edelstahl-Griffen, 1 mm dick
with gold plated handles, 1 mm thickness
grosor 1 mm., asas doradas
épaisseur 1 mm, poignées dorées



	cm	↑ cm	ltr.
61190	19	3,5	0,7
61280	28	4,0	2,0
61400	40	5,0	4,5



Servierpfanne

pan
fuente para la mesa
plat pour la table

mit vergoldeten Edelstahl-Griffen, 1 mm dick
with gold plated handles, 1 mm thickness
grosor 1 mm., asas doradas
épaisseur 1 mm, poignées dorées



	cm	↑ cm	ltr.
60270	26,5 x 19,5	3	0,8
60310	31,0 x 21,5	3	1,2



Tablett „FINESSE“

tray
bandeja
plateau



	cm
01314	30 x 24
01313	35 x 24
01317	39 x 26
01312	42 x 31
01318	48 x 30
01311	50 x 38
01310	58 x 42
01309	68 x 48



Tablett „FINESSE“

tray
bandeja
plateau



	Ø cm
01332	32,0
01335	35,0
01338	38,0
01348	48,0
01349	48,5
01358	58,0



Tablett „FINESSE“

tray
bandeja
plateau



	cm
01322	42 x 30
01323	50 x 36
01324	60 x 41
01325	70 x 46



Tablett „FINESSE“

tray
bandeja
plateau



verchromte Messing-Griffe
chrome plated brass handles
asas plateadas de latón
poignées en laiton chromées

	Ø cm
01738	38
01748	48



Tablett „FINESSE“

tray
bandeja
plateau

verchromte Messing-Griffe
chrome plated brass handles
asas de latón cromadas
poignées en laiton chromées



	cm	
01712	44 x 31	
01711	52 x 38	
01710	60 x 42	
01709	70 x 48	



Tablett mit Haube „FINESSE“

tray with cover
bandeja con campana
plateau avec cloche



	cm	↑ cm
13122	42 x 31	8,5



Tablett mit Haube „FINESSE“

tray with cover
bandeja con campana
plateau avec cloche



	Ø cm	↑ cm
13622	22	9,5



Tablett mit Haube „FINESSE“

tray with cover
bandeja con cubierta
plateau avec cloche



	Ø cm	↑ cm	Ø cm Hauben / cover
13382	38	12	30
13385	38	13	33



Edelstahltablett

tray
bandeja
plateau



	cm	↑ cm
09010	43,5 x 32,5	1,5

Rolltophaube „PURE“ / rolltop cover / campana abatible / cloche basculante

	cm	↑ cm
09013	44 x 33,5	17

Buffet & Display



Tablett „ELEGANCE“

tray
bandeja
plateau



	cm	
02310	41 x 26	
02311	48 x 30	
02312	60 x 37	



Tablett mit Haube „ELEGANCE“

tray with cover
bandeja con cubierta
plateau avec cloche



	cm	↑ cm
23642	35 x 19	10



Serviertablett mit Haube

tray
bandeja
plateau



	cm	↑ cm
00064	33 x 17	10
00067	25 x 19	7

Haube für 00064 / cover for 00064 / campana para 00064 / cloche pour 00064

06401

Haube für 00067 / cover for 00067 / campana para 00067 / cloche pour 00067

06701



Tortenplatte mit Haube

cake plate with cover
bandeja tarta con campana
plat à tarte avec cloche



	Ø cm	↑ cm	
00065	30	11	mit 1 Haube / with 1 cover
00652	30	7 + 11	mit 2 Hauben / with 2 cover



Tortenplatte „BAROCK“

cake plate
bandeja tartas
plat à gâteau



2-teilig: Tortenplatte mit Barock-Rand + Haube (extra stabil)

2 pcs. set: cake plate with decor edge „Barok“ + cover (extra robust)

set de 2: porta tartas, borde decor „Barok“ + campana (extra fuerte)

set de 2: plateau bord décor „Barok“ + cloche ultra-résistante

	Ø cm	↑ cm
06503	32	10

Frischhalte-Haube / cover / campana / cloche

	Ø cm	↑ cm
06510	30	11,5



Käseglocken-Set „BRAZIL“

rolltop set
set rolltop
set cloche á fromage



3-teilig: Tablett + Holzschneidebrett + Rolltophaube glasklar, rutschfeste Haubenfixierung

3 pcs. set: tray + wooden board + rolltop cover, cover non-slip fixed

set de 3: bandeja + tablero de madera + campana abatible, fijación antideslizante

set de 3: plateau + planche à découper + cloche abattante, fixation antiglisse

	Ø cm	↑ cm
09085	45	24



Ø 38 cm / 50 cm

Rolltop-Set

rolltop set
set rolltop
set cloche à fromage



2-teilig: Tablett + Rolltophaube glasklar, rutschfeste Haubenfixierung, klappbar

2 pcs. set: tray + rolltop cover, cover non-slip fixed, mountable

set de 2: bandeja + campana abatible fijación antideslizante, montable

set de 2: plateau + cloche abattante, fixation antiglisse, montable

	Ø cm	↑ cm
09080	38	24
09099	50	28



Rolltop-Set

rolltop set
set rolltop
set rolltop



2-teilig: Schneidbrett marmoriert + Rolltophaube glasklar, rutschfeste Haubenfixierung, klappbar

2 pcs. set: plastic board + rolltop cover, cover non-slip fixed, mountable

set de 2: tablero de plástico + tapa abatible, tapa antideslizante, montable

set de 2: planche à découper + cloche abattante, fixation antiglisse, montable

	Ø cm	↑ cm
09081	38	24



Rolltop-Set, 3-teilig

rolltop set, 3 pcs.
rolltop, set de 3
rolltop, set de 3



1 Edelstahltablett Ø 38 cm + 1 Naturschieferplatte Ø 33 cm + 1 Rolltophaube Ø 38 cm

1 stainless tray Ø 38 cm + 1 natural slate tray Ø 33 cm + 1 rolltop cover Ø 38 cm

1 bandeja de acero inoxidable Ø 38 cm + 1 bandeja de pizarra natural Ø 33 cm + 1 tapa abatible Ø 38 cm

1 plat inox 38 cm + 1 plat ardoise naturelle 33 cm + 1 cloche 38 cm

	Ø cm	↑ cm
01000	38	24



Buffet-Set, 2-teilig

buffet set, 2 pcs.
set de bufé, set de 2
présentoir pour le buffet, set de 2



1 Platte + 1 Rolltophaube, schneidfeste und porenfreie Oberfläche, rutschfeste Haubenfixierung, Platte mit rutschfesten Füßen

2 pcs. set: glass board + rolltop cover, scratch-resistant surface, cover non-slip fixed, non-slip feet

set de 2: bandeja vidrio redonda + campana abatible, fijación antideslizante, pies antideslizantes

set de 2: plateau verre rond + cloche abattante, fixation antiglisse et pieds antidérapants

	Ø cm	↑ cm
00978	38	23

PARTYPLATTEN

Nicht säure- und spülmaschinenfest, Lebensmittel nur mit Papierdeckchenunterlage servieren.

Non-acid and dishwasher-proof, serve food only with paper tray covers.

No resistente a los ácidos y al lavavajillas, servir alimentos sólo con papel para bandeja party.

Pas résistant aux acides et au lave-vaisselle, servent la nourriture seulement avec papier dentelles.



00393 oder / or 00396
96 x

00391 oder / or 00398
96 x

00392 oder / or 00399
96 x

00394 oder / or 00395
96 x

Warenträger

display
expositor
présentoir

für Partyplatten

- platzsparende flexible Präsentation durch geringe Abmessungen
- als Zweitplatzierung für Ihre zusätzlichen Umsätze
- in weiß lieferbar

for partytrays- space saving presentation- small size- available in white
para bandejas Party, ocupa poco espacio, disponible en blanco
pour plateaux Party, occupe très peu d'espace, disponible en blanc

	cm	↑ cm
00397	55 x 65	190



Partyplatte „CLASSIC“

partytray
bandeja party
plateau party



mit Liniendekor, Rand eingerollt

with line decor, rolled edge
con filos en relieve
avec décoration lignée, bord rond

	Ø cm	VE / unit
00396	35	48



Partyplatte „CLASSIC“

partytray
bandeja party
plateau party



mit Liniendekor, Rand eingerollt

with line decor, rolled edge
con filos en relieve
avec décoration lignée, bord rond

	cm	VE / unit
00398	46 x 34	48



Partyplatte „CLASSIC“

partytray
bandeja party
plateau party



mit Liniendekor, Rand eingerollt

with line decor, rolled edge
con filos en relieve
avec décoration lignée, bord rond

	cm	VE / unit	GN
00395	53,0 x 32,5	36	1/1
00399	41,0 x 31,0	48	
00389	35,4 x 32,5	48	2/3

hot price



Partyplatte
partytray
bandeja party
plateau party



Innenfläche ziseliert, Rand eingerollt
rolled edge, decorated surface
borde redondeado, superficie totalmente decorada
bord rond, surface entièrement ciselée

	Ø cm	VE / unit
00393	35	48

hot price



oval

Partyplatte
partytray
bandeja party
plateau party



Innenfläche ziseliert, Rand eingerollt
rolled edge, decorated surface
borde redondeado, superficie totalmente decorada
bord rond, surface entièrement ciselée

	cm	VE / unit
00391	46 x 34	48

hot price



Partyplatte
partytray
bandeja party
plateau party



Innenfläche ziseliert, Rand eingerollt
rolled edge, decorated surface
borde redondeado, superficie totalmente decorada
bord rond, surface entièrement ciselée

	cm	VE / unit
00392	41 x 31	48

hot price



GN 1/1

GN 1/1 Partyplatte
GN partytray
GN bandeja party
GN plateau party



Innenfläche ziseliert, Rand eingerollt
rolled edge, decorated surface
borde redondeado, superficie totalmente decorada
bord rond, surface entièrement ciselée

	cm	VE / unit	GN
00394	53 x 32,5	36	1/1

Buffet & Display

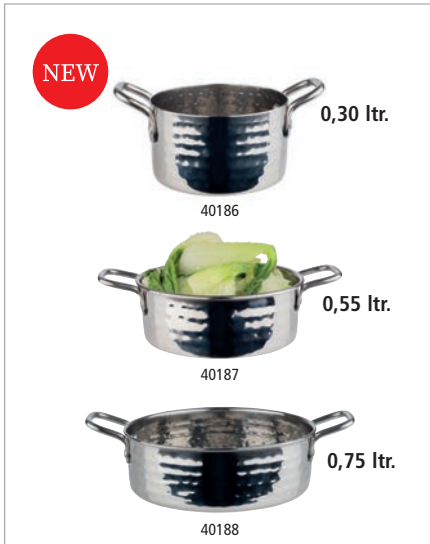

Serviertöpfchen

small serving pot
olla pequeña de servir
marmite petite de servir



gehämmerte Oberfläche
hammered surface
superficie martillada
surface martelée

	Ø cm	↑ cm	ltr.	Griff
40186	9,5	5,5	0,30	2,5
40187	13,5	5,0	0,55	3,0
40188	15,5	5,0	0,75	3,0



Kaviarkühler

caviar cooler
enfriador de caviar
rafraîchisseur de caviar



4-teilig: 1 Edelstahlschale, 1 Halter, 1 Glashalm, 1 Edelstahldeckel

4 pcs.: 1 stainless steel bowl, 1 holder, 1 glass bowl Ø 10 cm, 1 stainless steel cover

set de 4: 1 bol de acero inoxidable, 1 soporte, 1 bol de vidrio Ø 10 cm, 1 tapa de acero inoxidable

set de 4: 1 bol en acier inox, 1 support, 1 bol en verre Ø 10 cm, couvercle en acierinox

	Ø cm	↑ cm
01699	18	12



matt poliert
satin polished finish

Serviertablett „KAFFEEHAUS“

tray
bandeja
plateau



matt poliert, oval, Rand ingerollt

satin polished finish, oval, rolled edge

pulido acabado efecto satinado, oval, borde redondeado

effet satin, ovale, bord rond

	cm	↑ cm	
30111	19,0 x 15,0	1	für Zucker und Sahne / for sugar and cream
30112	26,5 x 19,0	1	für eine Tasse / for one cup
30113	29,0 x 22,0	1	für zwei Tassen / for two cups
30123	23,0 x 17,5	1	für zwei Tassen / for two cups



hochglanzpoliert
mirror polished finish

Serviertablett „KAFFEEHAUS“

tray
bandeja
plateau



hochglanzpoliert, oval, Rand ingerollt

mirror polished finish, oval, rolled edge

pulido efecto espejo, ovalado, borde redondeado

effet brillant, ovale, bord rond

	cm	↑ cm	
30115	19,0 x 15	1	für Zucker und Sahne / for sugar and cream para azúcar y crema / pour le sucre et la crème
30116	26,5 x 19	1	für eine Tasse / for one cup para una taza / pour une tasse
30117	29,0 x 22	1	für zwei Tassen / for two cups para dos tazas / pour deux tasses



Serviertablett „KAFFEEHAUS“

tray
bandeja
plateau

matt poliert, Rand eingerollt
satin polished finish, rolled edge
acabado pulido satinado, borde redondeado
effet satin mat, bord rond



	cm	↑ cm
30118	21,5 x 13	1,5
30119	23,0 x 23	1,5
30120	20,0 x 11	1,5
30121	29,0 x 20	1,5



mattiert
satin polished finish

Serviertablett „KAFFEEHAUS“

tray
bandeja
plateau

mattiert / satin polished finish
acabado efecto satinado / fini mat effet satin



	cm	↑ cm	
30126	25,5 x 19,5	2	mattiert / satin polished finish acabado efecto satinado / fini mat effet satin



84253

Serviertablett „KAFFEEHAUS“

tray
bandeja
plateau

Farbe / Colour



	cm	↑ cm	Farbe / Colour
84251	26,0 x 20,0	1,5	■
84253	28,5 x 21,5	1,5	■



hot price

Serviertablett „KAFFEEHAUS“

tray
bandeja
plateau

Innenfläche ziseliert, Rand eingerollt
rolled edge
borde redondeado, superficie decor relieve
bord rond, surface entièrement ciselée



	cm	pcs.
30114	30 x 22	48

NEW



30130



30131



30132



30132



30133



30133

Tablett „VINTAGE“

tray
bandeja
plateau



Edelstahl-Look vintage
stainless steel vintage look
acero inoxidable look vintage
acier inox look vintage

	cm	↑ cm
30130	26,0 x 13,5	1,5
30131	34,0 x 18,0	1,5
30132	38,0 x 26,5	1,5
30133	25,5 x 16,0	3,0

passende Schälchen / fitting bowls / cuencos adecuados / bols apropiés



	Ø cm	↑ cm	ltr.
40655	7,5	5,5	0,17
40656	7,5	10,0	0,35



S. 276
page 276



30130



30132

Servierbeispiel
presentation example

Tablett „TREND“

baking sheet
bandeja
plateau



ein Backblech wird zum Serviertablett
a baking sheet which becomes a serving tray
una bandeja de hornear que se convierte en una bandeja de servir
un moule qui devient un plateau de service

	cm	↑ cm
13380	32 x 21,5	2





Servier- und Tortenplatte „ACACIA MINI“

cake stand
porta pasteles
présentoir à gâteaux

Akazienholz geölt
acacia wood oiled
madera de acacia aceitada
bois d'acacia huilé



	Ø cm	↑ cm
33290	9,5	7
33291	13,0	9



Servier- und Tortenplatte „ACACIA“

cake stand
porta pasteles
présentoir à gâteaux

Akazienholz geölt
acacia wood oiled
madera de acacia aceitada
bois d'acacia huilé



	Ø cm	↑ cm
33292	24,0	8
33293	24,0	16
33294	33,0	8
33295	33,0	16
33296	38,5	8
33297	38,5	16



Frischhalte- Haube / cover / campana / cloche



	Ø cm	↑ cm	fits to
06519	21	17	33292, 33293
06520	30	22	33294, 33295
06521	36	27	33296, 33297

NEW CLASSIC



Servier- und Tortenplatte „CLASSIC“

cake stand
porta pasteles
présentoir à gâteaux



Rand fixiert die Haube
carved edge fixes the cover
ranura para fijar bien la campana
bord rainuré pour maintenir ferme la cloche

	Ø cm	↑ cm
85049	21,5	9
85050	21,5	17
85051	30,5	9
85052	30,5	17
85053	37,5	9
85054	37,5	17

Frischhalte- Haube / cover / campana / cloche



	Ø cm	↑ cm	fits to
06519 NEW	21	17	85049, 85050
06520	30	22	85051, 85052
06521 NEW	36	27	85053, 85054

Frischhalte- Haube / cover / campana / cloche



	Ø cm	↑ cm	fits to
06512	30	11,5	85051, 85052



Konditorplatte
 cake stand
 soporte para pastel
 présentoir à gâteaux



matt poliert
 satin polished finish
 acabado efecto satinado
 poli mat effet satin

	Ø cm	↑ cm
00046	31	3



Servier- / Tortenplatte
 cake stand
 soporte para pastel
 présentoir à gâteaux



Fuß hochglanzpoliert, Platte matt poliert, stabil und sehr standsicher
 foot mirror polished finish, plate satin polished finish
 pie pulido brillante, bandeja pulida mate
 pied brillant, plateau poli satin mat

	Ø cm	↑ cm
00462	30	11



Servier- / Tortenplatte
 cake stand
 soporte para pastel
 présentoir à gâteaux



matt poliert, drehbar, möbelschonende Moosgummi-Unterseite
 satin polished finish, rotating, foam rubber below to save your furniture
 acabado pulido satinado, giratorio, base revestida de goma para no rallar el mobiliario
 poli satiné, plateau tournant, revêtement mousse sous le pied pour ne pas rayer les meubles

	Ø cm	↑ cm
00463	30,5	9



Servier- / Tortenplatte
 cake stand
 soporte para pastel
 présentoir à gâteaux



Fuß matt poliert, stabil und sehr standsicher, möbelschonende Moosgummi-Unterseite
 foot satin polished finish, foam rubber below to save your furniture
 pie pulido con efecto satinado, base revestida de goma para no rallar el mobiliario
 inox poli satin, revêtement mousse sous le pied pour ne pas rayer les meubles

	Ø cm	↑ cm
00464	30	11

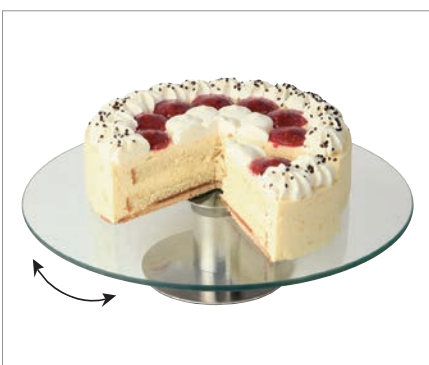

Servier- / Tortenplatte
 cake stand
 soporte para pastel
 présentoir à gâteaux



Fuß matt poliert, drehbar, möbelschonende Moosgummi-Unterseite
 foot satin polished finish, rotating, foam rubber below to save your furniture
 vidrio, pie inox satinado giratorio, base de goma para proteger el mobiliario
 plateau en verre, pied tournant inox poli satin, revêtement mousse sous le pied anti-rayures

	Ø cm	↑ cm
00444	30	7

Buffet & Display

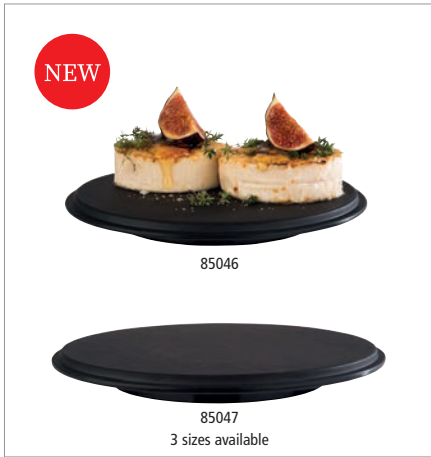

Torten- / Konditorplatte „SLATE“

cake stand
soporte para pastel
présentoir à gâteaux



Rand fixiert die Haube, mit Antirutsch-Füßchen, Schiefer Look
carved edge fixes the cover, with non-slip feet, slate look
ranura para fijar bien la campana, con pies antideslizantes, aspecto pizarra
bord rainuré pour maintenir ferme la cloche, avec pieds antidérapants, aspect ardoise



	Ø cm	↑ cm	passende Haube / suitable cover / campana adecuada / cloche appropriée
85046	21,5	2,5	06519 NEW
85047	30,5	3,5	06520, 06512, 6510
85048	37,5	4,0	06521 NEW



Torten- / Konditorplatte „LOOPS“

cake stand
soporte para pastel
présentoir à gâteaux



	Ø cm	↑ cm	passende Haube / suitable cover / campana adecuada / cloche appropriée
85033	21,5	2,5	06519 NEW
85034	30,5	3,5	06520, 06512, 06510
85035	37,5	4,0	06521 NEW

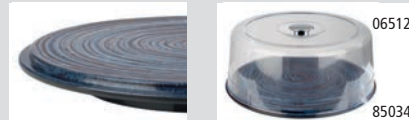

Rand fixiert die Haube, mit Antirutsch-Füßchen
carved edge fixes the cover, with non-slip feet



Torten- / Konditorplatte

cake stand
soporte para pastel
présentoir à gâteaux



Rand fixiert die Haube, mit Antirutsch-Füßchen
carved edge fixes the cover, with non-slip feet
ranura para fijar bien la campana, con pies antideslizantes
bord rainuré pour maintenir ferme la cloche, avec pieds antidérapants



	Ø cm	↑ cm	Farbe / Colour	fits to
00468	31	3,5	■	06520
00469	31	3,5	■	06520



Servier- und Tortenplatte „CASUAL“

cake plate
porta pasteles
présentoir à gâteaux



	Ø cm	↑ cm
83890	31	8
83891	31	16



Servier- und Tortenplatte „CASUAL“

cake plate
porta pasteles
présentoir à gâteaux



	cm	↑ cm
83892	31 x 31	8
83893	31 x 31	16

Naturschiefer



VERSIEGELT
SEALED
**PREMIUM
QUALITY**
EXTRA STARK
STRONG



00990
GN 1/1

00991
GN 1/2

00992
GN 1/3

00993
GN 1/4

GN Naturschieferplatten

GN natural slate tray
GN bandeja de pizarra natural
GN plat ardoise naturelle



hervorragende Kältespeicherung durch Naturschiefer, die Kanten der Platten sind gebrochen und nicht gesägt
excellent coldness store, food safe, waterproof
excelente conservador del frio, para reforzar la estética natural, los bordes ofrecen un canto irregular
excellent maintien du froid, les bords sont volontairement cassés pour renforcer l'esthétique naturelle

	cm	✱ mm	GN
00990	53,0 x 32,5	6 - 9	1/1
00991	32,5 x 26,5	6 - 9	1/2
00992	32,5 x 17,6	6 - 9	1/3
00993	26,5 x 16,2	6 - 9	1/4
00973	53,0 x 16,2	6 - 9	2/4



Naturschieferplatte

natural slate tray
bandeja de pizarra natural
plat ardoise naturelle



	cm	✱ mm
00996	45 x 30	6 - 9



00994

Naturschieferplatte

natural slate tray
bandeja de pizarra natural
plat ardoise naturelle



	cm	✱ mm
00994	25 x 25	6 - 9
00995	30 x 30	6 - 9

Buffet & Display

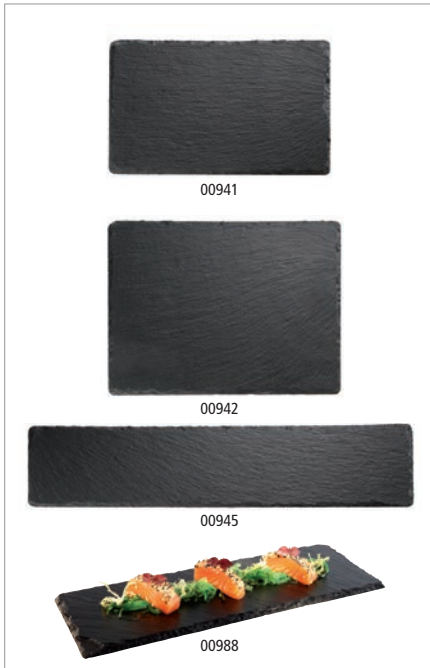

Naturschieferplatte

natural slate
bandeja de pizarra natural
plateau ardoise naturelle



	cm	✱ mm
00941	24,0 x 15,0	6 - 9
00942	26,5 x 20,5	6 - 9
00945	47,0 x 10,0	6 - 9
00988	30,0 x 12,0	6 - 9

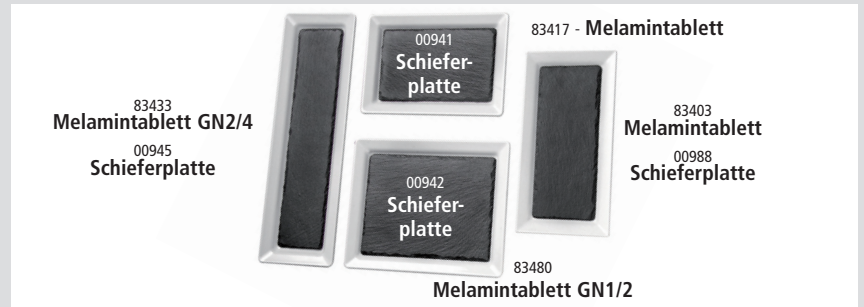

GN 1/1 Naturschieferplatte „HOCHSTAPLER“

GN 1/1 natural slate tray
GN 1/1 bandeja de pizarra natural
GN 1/1 plat ardoise naturelle



	cm	↑ cm	✱ mm
00966	53 x 32,5	6	6 - 9



Griffe verchromt, 4 cm Nutzhöhe
chrome plate handles, 4 cm distance



Naturschieferplatte

natural slate tray
bandeja pizarra natural
plat ardoise naturelle



mit Absatz Ø 6 cm
with hole Ø 6 cm
con agujero Ø 6 cm
avec trou Ø 6,0 cm

	cm	✱ mm
00986	25 x 12	6 - 9

passende Gläser:
82310, 82312, 82314, 82316



Naturschieferplatte

natural slate tray
bandeja pizarra natural
plat ardoise naturelle



mit 3 Absätzen, Ø 6 cm
with 3 holes, Ø 6 cm
con 3 agujeros, Ø 6 cm
avec 3 trous, Ø 6 cm

	cm	✱ mm
00987	28 x 10	6 - 9

passende Gläser:
82310, 82312, 82314, 82316



Naturschieferplatte „STARTER“

natural slate tray
bandeja de pizarra natural
plat ardoise naturelle carré



	cm	mm
00937	20 x 10	6 - 9



Naturschieferplatte / Untersetzer

natural slate tray
bandeja de pizarra natural
plateau ardoise naturelle



mit 2 Absätzen Ø 6 cm
with 2 holes Ø 6 cm
con 2 agujeros Ø 6 cm
avec 2 trous Ø 6 cm

	cm	mm
00971	15 x 8	6 - 9



Naturschieferplatte

natural slate tray
bandeja de pizarra natural
plat ardoise naturelle



	Ø cm	mm
00968	22	6 - 9
00969	28	6 - 9
00998	33	6 - 9
00999	38	6 - 9



Tortenplatte / Servierplatte drehbar

cake stand
soporte para pastel
présentoir à gâteaux



	Ø cm	↑ cm	mm
00975	32	2,5	6 - 9



drehbar
rotating



Rolltop-Set, 3-teilig

rolltop set, 3 pcs.
rolltop, set de 3
rolltop, set de 3



1 Edelmetalltablett Ø 38 cm + 1 Naturschieferplatte Ø 33 cm + 1 Rolltophaube Ø 38 cm
1 stainless tray Ø 38 cm + 1 natural slate tray Ø 33 cm + 1 rolltop cover Ø 38 cm
1 bandeja de acero inoxidable Ø 38 cm + 1 bandeja de pizarra natural Ø 33 cm + 1 tapa abatible Ø 38 cm
1 plat inox 38 cm + 1 plat ardoise naturelle 33 cm + 1 cloche 38 cm

	Ø cm	↑ cm
01000	38	24



3-stufige Etagère

3-tier tray
bandeja con tres alturas
étagère carré 3 hauteurs

Naturschiefer, Akazienholz
natural slate tray, wood akazie
bandeja de pizarra natural, madera de acacia
plateau ardoise naturelle, bois d'acacia



	∅ cm	↑ cm	* mm
00960	30 / 25 / 20	34	6 - 9



2-stufige Etagère

2-tier tray
bandeja dos alturas
étagère carré 2 hauteurs

Naturschiefer
natural slate tray
bandeja de pizarra natural
plateau ardoise naturelle



	∅ cm	↑ cm	* mm
00989	25 / 20	24	6 - 9



Naturschieferplatte, 2-teilig

natural slate tray, 2 pcs. set
bandeja de pizarra natural y campana
plateau ardoise naturelle et cloche en verre

mit Glashaube
with glass cover
con tapa de cristal
avec cloche en verre



	∅ cm	↑ cm	* mm
00984	10,5	8	6 - 9



Naturschieferplatten, 4er Set

natural slate tray, 4 pcs. set
bandeja pizarra natural, set de 4
plat ardoise naturelles, set de 4



	cm	* mm	pcs.
00997	10 x 10	6 - 9	4



GENUSSPALETTE



GN 1/1 Servierbrett „GENUSSPALETTE“

GN 1/1 serving board
GN 1/1 tabla de servir
GN 1/1 planche de service

HOLZ
WOOD



Genusspalette im Kleinformat, Birke
mini serving palett, birch
tabla de servir, formato pequeño, abedul
planche de service, petit format, bouleau

	cm	↑ cm	GN
00879	53 x 32,5	3	1/1



Servierbrett „GENUSSPALETTE“

serving board
tabla de servir
planche de service

HOLZ
WOOD



Genusspalette im Kleinformat, Birke
mini serving palett, birch
tabla de servir, formato pequeño, abedul
planche de service, petit format, bouleau

	cm	↑ cm
00880	20 x 12	3
00881	30 x 20	3
00882	40 x 15	3

Wachspapier „SNACKHOLDER“ / greaseproof paper squares
papel alimenticio para cucurucho / papier alimentaire pour cornet

	cm	pcs.	
40670	42 x 25	500	Motiv: Zeitung
40671	42 x 25	500	blank
40672	42 x 25	500	Motiv: rote Karos / red
40673	42 x 25	500	Motiv: blaue Karos / blue
40674	30 x 20	500	Motiv: Fast Food / black



40674



40670



40672



40673



NEW

mit Absatz Ø 5 cm
with hole Ø 5 cm

Servierbrett, 2-tlg.
serving board, 2 pcs. set
tabla de servir, set de 2
planche de service, set de 2

SCHIEFER
SLATE

HOLZ
WOOD



2-teilig:
1 Holzbrett aus Akazienholz + 1 Naturschieferplatte
1 wood board made of acacia wood + 1 natural slate tray
1 tabla de madera de acacia + 1 pizarra natural
1 planche en bois d'acacia + 1 ardoise naturelle

	cm	↑ cm
00814	28 x 17,5	2

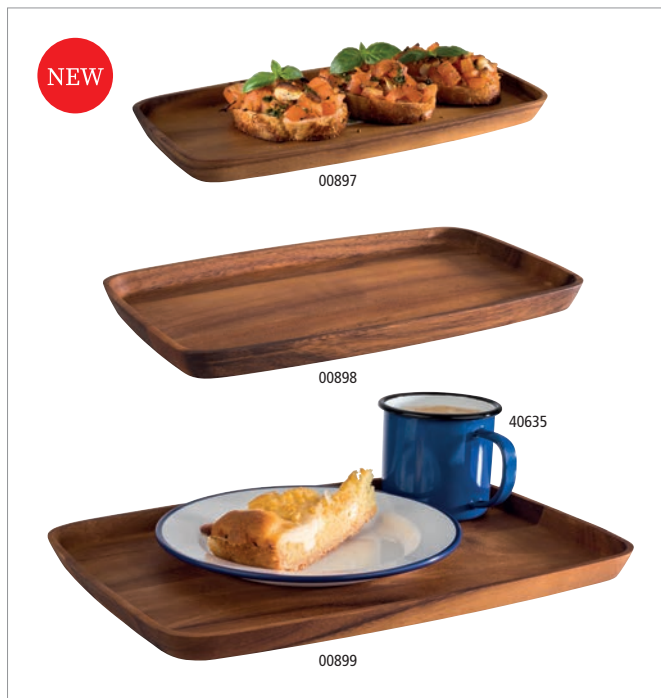

NEW

00897

00898

40635

00899

Servierbrett
serving board
tabla de servir
planche de service



Servierbrett aus geöltem Akazienholz
serving board made of oiled acacia wood
tabla de servir de madera de acacia aceitada
planche en bois avec plateau en bois d'acacia huilé

	cm	↑ cm
00897	30 x 15	2
00898	30 x 18	2
00899	35 x 25	2



NEW

00810

00811

00812

00813

Servierbrett, 2-tlg.
serving board, 2 pcs. set
tabla de servir, set de 2
planche de service, set de 2

SCHIEFER
SLATE

HOLZ
WOOD



2-teilig:
Ein rustikales Servierbrett aus Akazienholz,
ausgestattet mit einer Naturschieferplatte
wood board oiled acacia with a slate tray
tabla de madera de acacia con una bandeja de pizarra natural
planche en bois d'acacia avec un plateau en ardoise naturelle

	cm	↑ cm
00810	26 x 18	2
00811	33 x 20	2
00812	40 x 15	2
00813	43 x 12	2

Präsentationsmöglichkeit
presentation example



00813

mit Hängeloch Ø 2 cm / with a handle-hole Ø 2 cm

NEW



Servierbrett
 serving board
 tabla de servir
 planche de service



Servierbrett aus geöltem Akazienholz
 serving board made of oiled acacia wood
 tabla de servir de madera de acacia aceiteada
 planche en bois d'acacia huilé

	cm	↑ cm	Griff / handle cm
00887	51,5 x 18	1,5	8,5



00867



00868

Servierbrett „AKAZIE-SCHIEFER“
 serving board
 tabla de servir
 planche de service

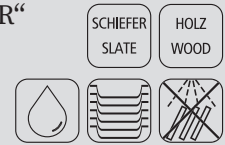

raffiniertes, rustikales Servierbrett
 aus Akazienholz, ausgestattet mit einem Naturschieferstreifen
 zur Kennzeichnung

wood with slate, markable
 madera con pizarra, se puede marcar
 bois avec ardoise, on peut mettre une inscription

	cm	↑ cm
00867	30,5 x 13	1,5
00868	36,5 x 15	1,5
00869	42,0 x 18	1,5



00870



00873



00875

Servierbrett „OLIVE“
 serving board
 tabla de servir en madera de olivo
 planche de service en bois d'olivier



Servierbrett im Naturschnitt, aus Olivenholz. Jedes Brett wird handgefertigt und geölt mit 19 mm Aufhäng Bohrung. Alle Produkte unterscheiden sich naturbedingt in Form, Maserung und Größe!

Olive Wood is known for its versatility and striking appearance with each piece having its own unique features.

El olivo es conocido por su versatilidad y aspecto espectacular y único en cada pieza. Por su fabricación a mano de forma artesanal, todas las piezas varían en tamaño, forma y acabado, lo que hace de cada una un ejemplar único.

Le bois d'olivier est reconnu pour sa versatilité et son esthétique spectaculaire. De par leur fabrication artisanale à la main, toutes les pièces varient quant à leur taille, forme et finition, de telle sorte que chacune est un exemplaire unique.

	cm	↑ cm	Griff / handle cm
00870	25 x 17,0	1,5	
00871	30 x 20,5	2,0	
00872	35 x 24,0	2,0	
00873	40 x 15,0	1,5	11
00874	44 x 20,0	2,0	12
00875	19 x 12,5	1,5	6
00876	25 x 16,0	1,5	8
00877	31 x 20,0	1,5	9



Servierbrett „OAK“

serving board
tabla de servir
planche de service



aus geöltem Eichenholz, Safrille, ø 9,5 cm runde Aussparung
made of oiled oak, with juice groove, with hole ø 9.5 cm
de madera de roble aceitada, con ranura para líquidos, con agujero ø 9,5 cm
en bois chêne huilé, avec rigole, avec trou ø 9,5 cm

	cm	↑ cm
00808	37 x 25	2



mit Safrinne / with juice groove

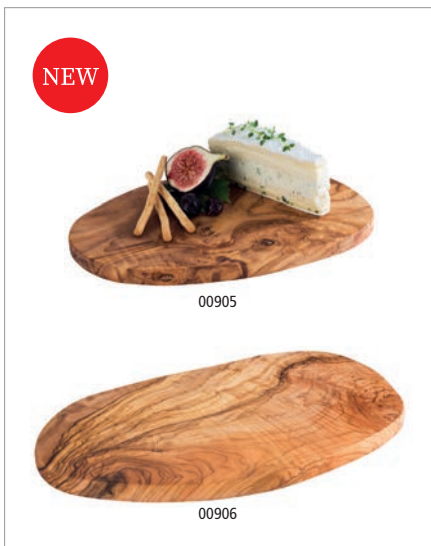

Servierbrett „OLIVE“

serving board
tabla de servir
planche de service



aus geöltem Olivenholz
oiled olive wood
de madera de olivo aceitada
en bois d'olivier huilé

	cm	↑ cm
00905	25,5 x 16,5	1,5
00906	35,0 x 20,5	1,5



Rindenholzbrett

wood plater
tabla de madera con corteza
planche en bois avec écorce



Akazienholz mit Rinde, jedes Brett ein Unikat,
vor dem Erstgebrauch mit Speiseöl behandeln
acacia wood with bark, each board unique,
treat with cooking oil before first use
madera de acacia con corteza, cada tabla un ejemplar
único, tartar con aceite de cocina antes del primer uso
bois d'acacia avec écorce, chaque planche une modèlle unique,
traiter avec de l'huile de caisson avant la première utilisation

	cm	↑ cm
00895	26 x 24,0	2
00896	30 x 28,5	2



Schale „OLIVE“

bowl
cuenco
bol



aus geöltem Olivenholz
oiled olive wood
de madera de olivo aceitada
en bois d'olivier huilé

	cm	↑ cm	litr.
00843	12,0 x 7,5	2,5	0,05
00844	16,5 x 9,5	2,5	0,10



Schale „OLIVE“

bowl
cuenco
bol



aus geöltem Olivenholz
oiled olive wood
de madera de olivo aceitada
en bois d'olivier huilé

	cm	↑ cm	litr.
00907	13 x 8	6,5	0,2
00908	16 x 9	7,0	0,3



Servierbrett „NARROW“

serving board
tabla de servir
planche de service



Akazienholz, mit 3 Vertiefungen Ø 6 cm
acacia wood, with 3 notches Ø 6 cm
madera de acacia, con 3 ranuras Ø 6 cm
bois d'acacia, avec 3 encoches Ø 6 cm

	cm	↑ cm
00878	31 x 11	2

passende Schälchen / fitting bowls / cuencos adecuados / bols apropiés

	Ø cm	↑ cm	litr.	
40685	6	3	0,05	stainless steel



Holzbox „TABLE“

woodbox
caja madera
base bois



Akazienholz, 3 Fächer (6,5 x 6,5 cm)
acacia wood, 3 compartments (6,5 x 6,5 cm)
madera de acacia, 3 compartimentos (6,5 x 6,5 cm)
bois d'acacia, 3 compartiments (6,5 x 6,5 cm)

	cm	↑ cm	inner size cm
11727	23,5 x 8,5	4,5	6,5 x 6,5 je Fach / each compartment



NEW

Buffetbrett „PROFI“



Buffetbrett „PROFI“

board
tabla para el buffet
planche découper buffet

aus geöltem Eichenholz, Safrinne, mit Antirutsch-Füßchen

made of oiled oak, with juice groove and non slip-feet

de madera de roble aceitada, con ranura para líquidos y pies antideslizantes

en bois chêne huilé, avec rigole et pieds antidérapants



	Ø cm	↑ cm	passende Haube / suitable cover / campana adecuada / cloche appropriée
00815	23	4,5	6519
00805	33	4,5	6520, 6510, 6512
00816	39	4,5	6521

Frischhalte- Haube / cover / campana / cloche



	Ø cm	↑ cm	fits to
06512	30	11,5	85051, 85052

Frischhalte- Haube / cover / campana / cloche



	Ø cm	↑ cm	fits to
06519	21	17	85049, 85050
06520	30	22	85051, 85052
06521	36	27	85053, 85054



Buffetbrett „PROFI“

board
tabla para el buffet
planche découper buffet

aus geöltem Eichenholz, Safrinne, mit Antirutsch-Füßchen

made of oiled oak, with juice groove and non slip-feet

de madera de roble aceitada, con ranura para líquidos y pies antideslizantes

en bois chêne huilé, avec rigole et pieds antidérapants



	cm	↑ cm	passende Haube / suitable cover / campana adecuada / cloche appropriée
00807	38 x 32,0	4,5	11021, 11022, 12008, 12010
00806	58 x 37,5	4,5	11026, 11027, 11028, 11008, 11010, 11016



Buffetbrett „XXL“

board
tabla para el buffet
planche à découper buffet



Buchenholz geölt, mit Antirutsch-Füßchen

beech wood oiled, with non-slip feet
madera de haya tratada con aceite, con pies antideslizantes
bois hêtre huilé, avec pieds antidérapants

	Ø cm	↑ cm
00866	50	4,5

Rolltophaube / rolltop cover / campana rolltop / cloche rolltop

	Ø cm	↑ cm
18380	50	26

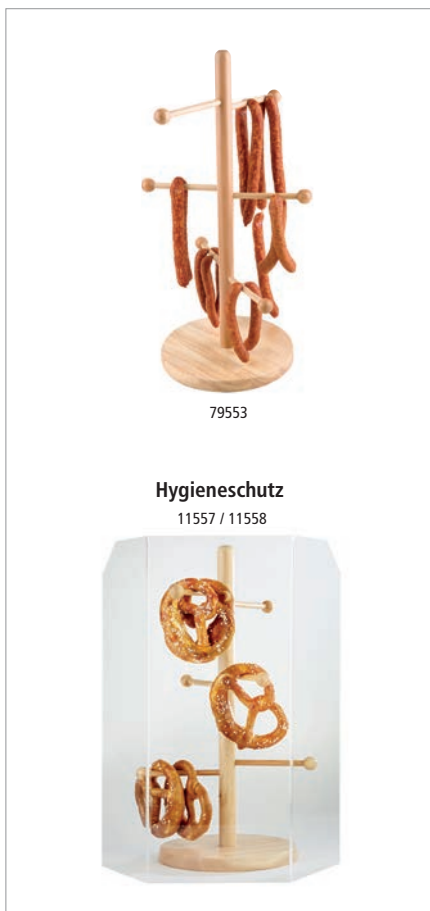

Brezel- oder Wurstständer

pretzel-/ sausage stand
soporte para embutidos
support à bretzel ou à saucissons



Verkaufsständer Buchen-Holz versiegelt, bestens geeignet für die Präsentation von Brezeln, Würstchen, etc., Fuß Ø 22 cm

beech wood, ideal to present pretzels, sausages, etc.
madera de haya, ideal para presentar fiambres, salchichones etc.
en hêtre, idéal pour bretzels ou saucissons, etc.

	Ø cm	↑ cm
79553	28	50

Hygieneschutz für Brezelständer / hygienic cover / cubierta higiénica antialiento / pare-haleine

	cm	↑ cm
11557	20 x 20 x 20	50
11558	15 x 20 x 15	50



Hobel für Käse und Schokolade

cheese / choco curler
rizador para queso y chocolate
frisette pour fromage et chocolat



3-teilig: Platte Buchen-Holz versiegelt Ø 22 cm mit senkrechtem Stift + Hobel 7 cm + Haube Ø 15 x 10 cm, für Käse und Schokolade

3 pcs. set: wooden base Ø 22 cm with vertical bolt + plough 7 cm + cover Ø 15 x 10 cm, for cheese and chocolate

set de 3: base de madera Ø 22 cm, con eje vertical de 7 cm + campana Ø 15 x 10 cm, para „rizar“ queso y chocolate

set de 3: base bois Ø 22 cm, axe vertical ht. 7 cm, cloche Ø 15 x ht 10 cm, pour „friser“ le fromage ou le chocolat.

	Ø cm	↑ cm
50002	22	15

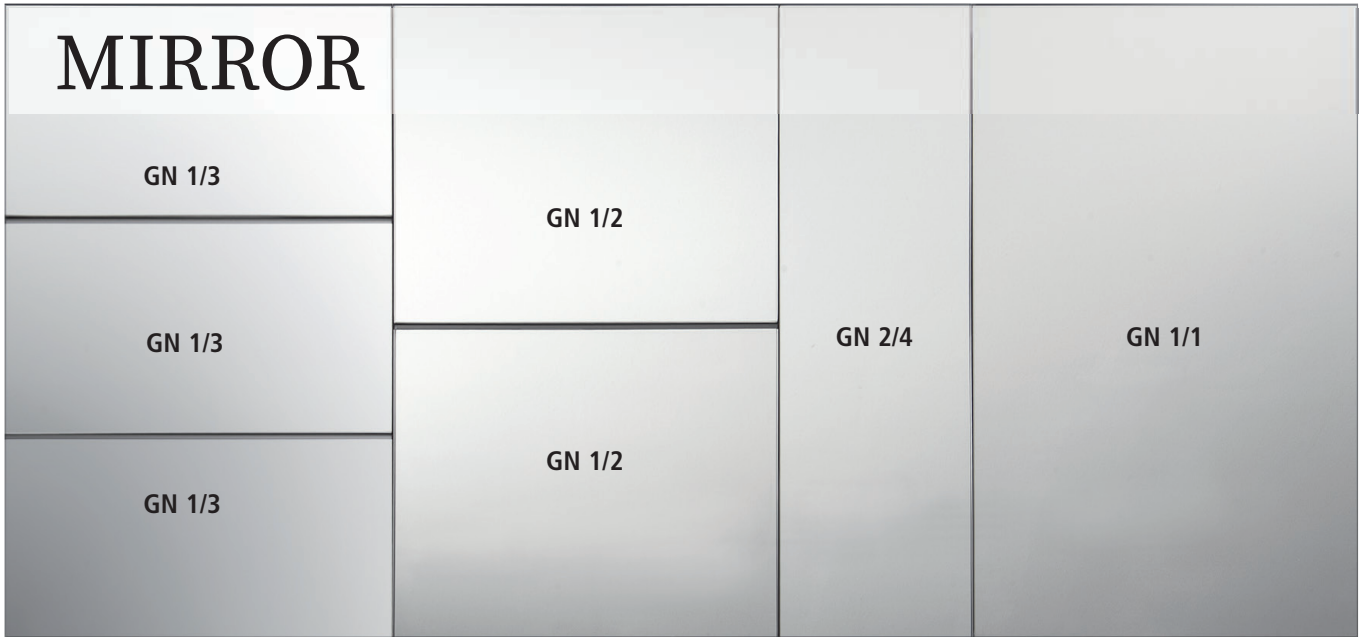

GN Glasplatte „MIRROR“

GN glass platter
GN espejos sobre vidrio
GN plateau miroir en verre



silber spiegelndes Glas, mit Antirutsch-Füßchen
silver mirror glas, non-slip feet
espejo plateado, pies antideslizantes
plateau miroir argenté, pieds antiglisse

	cm	↑ cm	GN
00961	53,0 x 32,5	3	1/1
00962	32,5 x 26,5	3	1/2
00963	32,5 x 17,6	3	1/3
00964	53,0 x 16,2	3	2/4



ZERO



GN Tablett „ZERO“

GN tray
GN bandeja
GN plateau



glatte, hochglänzende Oberfläche
smooth and shiny surface
superficie lisa con acabado brillante
surface lisse et finition brillante

	cm	↑ cm	GN	Farbe / Colour
84185	53,0 x 32,5	1,5	1/1	White
84186	32,5 x 26,5	1,5	1/2	White
84187	32,5 x 17,6	1,5	1/3	White
84188	26,5 x 16,2	1,5	1/4	White
84189	53,0 x 16,2	1,5	2/4	White
84195	53,0 x 32,5	1,5	1/1	Black
84196	32,5 x 26,5	1,5	1/2	Black
84197	32,5 x 17,6	1,5	1/3	Black
84198	26,5 x 16,2	1,5	1/4	Black
84199	53,0 x 16,2	1,5	2/4	Black



GN Tablett „FRAMES“

GN tray
GN bandeja
GN plateau



	cm	↑ cm	GN
82355	53,0 x 32,5	2	1/1
82356	32,5 x 26,5	2	1/2
82357	32,5 x 17,6	2	1/3



Präsentationsmöglichkeit / presentation opportunity



GN Tablett

GN tray
GN bandeja
GN plateau



	cm	↑ cm	GN
82201	53,0 x 32,5	2,5	1/1
82202	32,5 x 26,5	2,5	1/2
82203	32,5 x 17,6	2,5	1/3
82204	53,0 x 16,2	2,5	2/4
82205	35,4 x 32,5	2,5	2/3



GN Tablett „FRAMES“

GN tray
GN bandeja
GN plateau



	cm	↑ cm	GN
84046	53,0 x 32,5	2	1/1
84047	32,5 x 26,5	2	1/2
84048	32,5 x 17,6	2	1/3



Serviertablett „HAPPY HOUR“

tray
bandeja
plateau



rutschfeste Oberfläche
non-slip surface
superficie anti deslizando
surface antidérapante

	Ø cm	↑ cm	Farbe / Colour
00510	32	1,5	■
00511	38	1,5	■
00515	43	1,5	■



Tablett „GASTRO“

tray
bandeja
plateau



rutschfeste Oberfläche
non-slip surface
superficie anti deslizando
surface antidérapante

	Ø cm	↑ cm	Farbe / Colour
00547	27,5	2	■
00548	35,5	2	■
00549	40,5	2	■



Tablett „BISTRO“

tray
bandeja
plateau



rutschfest, mit 2 Griffmulden und Stapelrand
non-slip, two open handles, stackable edge
anti deslizando, 2 asas
antidérapant, 2 anses

	Ø cm	↑ cm	Farbe / Colour
84045	35,5	4,5	■



Bierglasträger „NONSLIP“

beer rack
bandeja para cerveza
porte verre à bière



rutschfeste Oberfläche
non-slip surface
superficie anti deslizando
surface antidérapante

	Ø cm	↑ cm	Farbe / Colour
00500	36	3,5	■
00501	36	3,5	■

	cm	↑ cm	Farbe / Colour
00506	28 x 20	1,5	■
00507	28 x 20	1,5	■



84620
oval 22 x 14 cm

84621
Ø 19 cm

Teller mit Glashalter „COCKTAIL“

plate with glass holder
plato sujeta copas
assiette porte-verre



eignet sich besonders für Stehempfänge, einhändig nutzbar
particularly suitable for standing receptions, single-handed use
para uso en recepciones de pie, facil de usar con sólo una mano
particulièrement pour des receptions debout, utilisable avec une seule main

	cm	↑ cm
84620	22 x 14	1,5



	Ø cm	↑ cm
84621	19	1,5



00505

Serviertablett „NONSLIP“

tray non-slip
bandeja
plateau



rutschfeste Oberfläche
non-slip surface
superficie antideslizante
surface antidérapante

	cm	↑ cm	GN	Farbe / Colour
00502	53,0 x 32,5	1,5	1/1	■
00508	46,0 x 36,0	2,0		■
00505	53,0 x 32,5	1,5	1/1	■
00503	53,0 x 37,0	1,5		■



00526

Tablett

tray
bandeja
plateau



rutschfest, Holzdekor-Laminat
non-slip, coated wood
antideslizante, decoración madera láminae
antidérapant, décor bois laminé

	cm	↑ cm
00524	43,5 x 31,5	1,5
00525	52,0 x 39,0	1,5
00526	60,5 x 42,5	1,5

Buffet & Display



Fast Food-Tablett

snack tray
bandeja autoservicio y snacks
plateau self-service et snacks



	cm	↑ cm	GN	Farbe / Colour
00530	35 x 27,0	2		
00535	41 x 30,5	2		
00540	45 x 35,5	2		
00552	53 x 32,5	2	1/1	

	cm	↑ cm	GN	Farbe / Colour
00531	35 x 27,0	2		
00536	41 x 30,5	2		
00541	45 x 35,5	2		
00553	53 x 32,5	2	1/1	

	cm	↑ cm	GN	Farbe / Colour
00532	35 x 27,0	2		
00537	41 x 30,5	2		
00542	45 x 35,5	2		
00554	53 x 32,5	2	1/1	

	cm	↑ cm	GN	Farbe / Colour
00533	35 x 27,0	2		
00538	41 x 30,5	2		
00543	45 x 35,5	2		
00555	53 x 32,5	2	1/1	



Tablett

tray
bandeja
plateau



rutschfest, Mahagonifurnier

non-slip, woodform, mahogany
antideslizante, revestimento de caoba
antidérapant, placage en acajou

	Ø cm	↑ cm	
00528	31,0	3,5	hoher Rand
00529	35,5	3,5	hoher Rand

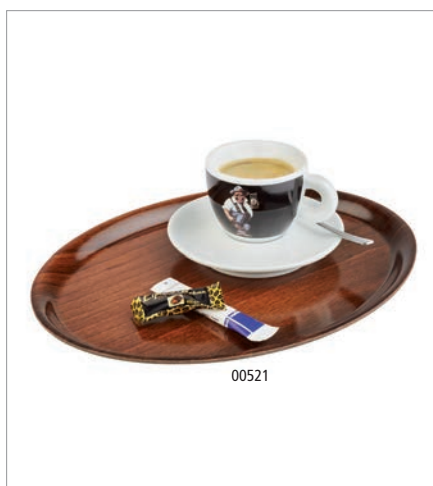

Tablett

tray
bandeja
plateau



rutschfest, Holzdekor-Laminat

non-slip, coated wood
antideslizante, limando decoracion madera
antidérapant, décor bois stratifié

	cm	↑ cm
00521	26 x 20	1
00522	29 x 21	1



DRESSINGTOPF-DISPLAY /-STATION

wooden station for 3 dressing pots
 expositor de madera para 3 salsaeras
 présentoir en bois pour 3 pots à sauce

inkl. 3 Beschriftungsschilder aus Metall

incl. 3 metal labels

incl. 3 etiquetas de metal

incl. 3 étiquettes métalliques



	cm	↑ cm
84863	40 x 16	9



passend für 83311, 83867, 30060
 suitable for 83311, 83867, 30060



Dressingtopf „PASTELL“

dressing pot
 salsaera
 pot à sauce



	cm	↑ cm	ltr.	Farbe / Colour
84862	13	19,5	1,5	
84860	13	19,5	1,5	
84861	13	19,5	1,5	

Beschriftungsetikett
 siehe S. 312
 labeling labels page 312

Beschriftungsetiketten, 72 Stück / labeling labels, 72 pcs. set
 etiquetas, 72 pzs / étiquettes, 72 pcs.

	cm	Farbe / Colour
00069	8 x 4,6	



mit Antirutschfüßchen
 with non-slip feet
 con pies antideslizantes
 avec pieds antidérapants



stapelbar
 stackable
 apilable
 empilable



Dressingtopf, doppelwandig „PROFI“

dressing pot, double wall
 salsaera alta, doble pared
 pot à sauce, double paroi

beste Isoliereigenschaften

best insulating properties

muy aislante

très isolant



	Ø cm	↑ cm	ltr.
30060	13	19	1,4

Beschriftungsetiketten, 72 Stück / labeling labels, 72 pcs. set
 etiquetas, 72 pzs / étiquettes, 72 pcs.

	cm	Farbe / Colour
00069	8 x 4,6	

Beschriftungsetikett siehe S. 312
 labeling labels page 312

Buffet & Display



Dressingtopf „CASUAL“

dressing pot
salsera
pot à sauce



	cm	↑ cm	ltr.	Farbe / Colour
83867	12	21,5	1	weiß



Dressingtopf „CASUAL“

dressing pot
salsera
pot à sauce



	cm	↑ cm	ltr.	Farbe / Colour
83868	12	21,5	1	schwarz



Dressingtopf, doppelwandig

bowl, double wall
salsera alta, doble pared
pot à sauce, double paroi



beste Isoliereigenschaften
best insulating properties
muy aislante
très isolant

	Ø cm	↑ cm	ltr.
30043	15	18	1,8



Dressingtopf

dressing pot
salsera
pot à sauce



Deckel mit Löffelaussparung
cover notched for spoon
tapa agujereada para el cucharón
couverture avec espace pour la louche

	Ø cm	↑ cm	ltr.
83309	18,5	17	2,3
83310	17,0	15	2,0
83311	13,0	13	0,8



Kühl-Akkus halten Ihre Speisen bis zu 6 Stunden kühl
cooler keeps the food until 6 hrs. cold

Buffetvitrine
showcase
vitrina de buffet
vitrine de buffet



1 transparente Rolltophaube beidseitig aufklappbar + 1 Schale (ABS)
+ 1 Edelstahl-Tablett 39 x 28 cm + 2 Kühl-Akkus

1 transparent rolltop cover + 1 tray (ABS) + 1 stainless tray 39 x 28 cm + 2 coolers, demountable

1 tapa abatible transparente + 1 bandeja (ABS) + 1 bandeja 39x28cm + 2 enfriadores, desmontable

1 cloche transparente ouverture 2 côtés + 1 caisson (ABS) + 1 plateau inox 39 x 28 cm + 2 accumulateurs de froid, démontable

	cm	↑ cm	Farbe / Colour
09100	44 x 32	20,5	
09102	44 x 32	20,5	
09104	44 x 32	20,5	

Kühlakku / cooler / acumulador de frío / accumulateur de froid

	cm	↑ cm	pcs.
11101	16 x 7,5	2	4

Edelstahl-Tablett / stainless steel tray / bandeja de acero inoxidable / plateau inox

	cm
90902	39 x 28



Kühl-Akkus halten Ihre Speisen bis zu 6 Stunden kühl
cooler keeps the food until 6 hrs. cold

Thermo Tablett-Set
thermo tray
bandeja termo
caisson thermo



1 stabile Schale + 1 Edelstahl-Tablett + 2 Kühlakkus + 1 Frischhaltehaube

1 plastic tray + 1 stainless tray + 2 coolers + 1 cover

1 bandeja de plástico + 1 bandeja inox + 2 acumuladores + 1 campana

1 plateau plastique + 1 plateau inox + 2 accumulateurs de froid + 1 cloche

	cm	↑ cm
09090	43 x 29	14

Kühlakku / cooler / acumulador de frío / accumulateur de froid

	cm	↑ cm	pcs.
11101	16 x 7,5	2	4

Haube / cover / campana / cloche

	cm	↑ cm
90901	43 x 29	14

Edelstahl-Tablett / stainless steel tray / bandeja de acero inoxidable / plateau inox

	cm
90902	39 x 28

Buffet & Display



Buffetvitrine „DOPPELDECKER“

showcase

vitrina de buffet, 2 alturas

vitrine de buffet double



2 transparente Rolltopphauben beidseitig aufklappbar + 2 Edelstahl-Tablets 39 x 28 cm + 4 Kühl-Akkus, platzsparend lagerbar

2 transparent rolltop cover + 2 tray 39 x 28 cm + 4 coolers, demountable, space saving

2 campanas abatibles por ambos lados + 2 bandejas 39 x 28 cm + 4 acumuladores, desmontable, ahorra espacio

2 cloches transparentes abattantes 2 côtés + 2 plateaux 39 x 28 cm + 4 accumulateurs de froid, gain d'espace

	cm	↑ cm	Farbe / Colour
09200	44 x 32	44	
09202	44 x 32	44	
09204	44 x 32	44	

Kühlakku / cooler / acumulador de frío / accumulateur de froid

	cm	↑ cm	pcs.
11101	16 x 7,5	2	4

Edelstahl-Tablett / stainless steel tray / bandeja de acero inoxidable / plateau inox

	cm
90902	39 x 28



Thermo Tablett-Set

thermo tray

bandeja termo

caisson thermo



1 stabile Schale + 1 Edelstahl-Tablett + 2 Kühlakkus + 1 Frischhaltehaube

1 plastic tray + 1 stainless tray + 2 coolers + 1 cover

1 bandeja de plástico + 1 bandeja inox + 2 acumuladores + 1 campana

1 plateau plastique + 1 plateau inox + 2 accumulateurs de froid + 1 cloche

	Ø cm	↑ cm
09093	35	15

Kühlakku / cooler / acumulador de frío / accumulateur de froid

	cm	↑ cm	pcs.
11101	16 x 7,5	2	4

Kühl-Akkus halten Ihre Speisen
bis zu 6 Stunden kühl
cooler keeps the food until
6 hrs. cold



Buffet-Set „FOCUS“

buffet set
set de buffet
présentoir pour le buffet

4-teilig: Box, Tablett, 2 Kühlakkus

4 pcs.: box, tray, 2 cooler
set de 4.: box, bandeja, 2 enfriadores
swt de 4: caisson, 2 plateau, bac



	cm	↑ cm	Farbe / Colour
09000	43,5 x 32,5	6	White
09001	43,5 x 32,5	6	Black

Edelstahltablett / tray / bandeja / plateau

	cm	↑ cm
09010	43,5 x 32,5	1,5

Holzschneidebrett / wooden board / tablero de madera / planche à découper

	cm	↑ cm
09016	43,5 x 32,5	2

Basisteil / base / base / base

	cm	↑ cm	Farbe / Colour
09011	42,5 x 31,5	6	White
09012	42,5 x 31,5	6	Black

Rolltophaube „PURE“ / rolltop cover / campana abatible / cloche basculante

	cm	↑ cm
09013	44 x 33,5	17

Kühlakku / cooler / acumulador de frío / accumulateur de froid

	cm	↑ cm
10791	25 x 19	2,5

Kühl-Akkus halten Ihre Speisen bis zu 6 Stunden kühl
cooler keeps the food until 6 hrs. cold



Buffet-Set „FOCUS“

buffet set
set de buffet
présentoir pour le buffet

3-teilig: Box, Tablett, 1 Kühlakku

3 pcs.: box, tray, 1 cooler
set de 3.: box, bandeja, 1 enfriador
set de 3: caisson, 1 plateau, bac



	Ø cm	↑ cm	Farbe / Colour
09002	38	6	White
09003	38	6	Black

Edelstahltablett / tray / bandeja / plateau

	Ø cm	↑ cm
09020	38	1,5

Basisteil / base / base / base

	Ø cm	↑ cm	Farbe / Colour
09021	37	6	White
09022	37	6	Black

Rolltophaube / rolltop cover / campana abatible / cloche basculante

	Ø cm	↑ cm
09023	38	20

Kühl-Akkus halten Ihre Speisen bis zu 6 Stunden kühl
cooler keeps the food until 6 hrs. cold

Buffet & Display

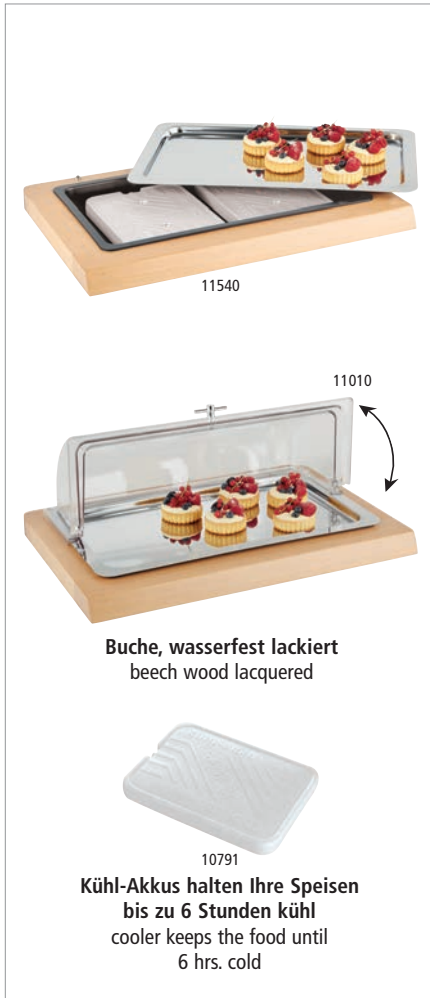

Buche, wasserfest lackiert
beech wood lacquered

Kühl-Akkus halten Ihre Speisen bis zu 6 Stunden kühl
cooler keeps the food until 6 hrs. cold

Buffetvitrine „TOP FRESH GN 1/1“

refrigerated buffet display
expositor buffet frío
plateau buffet froid



4-teilig: 1 Holzbox mit Kunststoffwanne + 1 Tablett GN 1/1 + 2 Kühlakkus

4 pcs. set: 1 woodbox with plastic insert + 1 stainless tray GN 1/1 + 2 coolers

set de 4: 1 base madera + 1 bandeja inox GN 1/1 + 2 acumuladores de frío

set de 4: 1 base bois + 1 plateau inox GN 1/1 + 2 accus de froid (cloche non incluse)

	cm	↑ cm
11540	60 x 41	5

GN Rolltophaube / GN rolltop cover / GN campana rolltop / GN cloche rolltop

	cm	↑ cm	GN
11008	53 x 32,5	19	1/1 Gold-Griff

GN Rolltophaube / GN rolltop cover / GN campana rolltop / GN cloche rolltop

	cm	↑ cm	GN
11010	53 x 32,5	19	1/1 Chrom-Griff

Kühlakku / cooler / acumulador de frío / accumulateur de froid

	cm	↑ cm
10791	25 x 19	2,5



Buche, wasserfest lackiert
beech wood lacquered

Kühl-Akkus halten Ihre Speisen bis zu 6 Stunden kühl
cooler keeps the food until 6 hrs. cold

Buffetvitrine „DOPPELDECKER“

cooling buffet display
expositor buffet frío
vitrine buffet



12-teilig: 2 Kästen Buchen-Holz versiegelt + 2 Tablett GN 1/1

+ 4 Kühlakkus + 4 Stangen, ohne Hauben

12 pcs. set: 2 beech wood boxes waterproof + 2 trays GN 1/1 + 4 coolers + 4 fittings, without covers

set de 12: 2 bases madera tratada + 2 bandejas inox GN 1/1 + 4 enfriadores + 4 pies (campanas no incl.)

set de 12: 2 caissons bois traité (hêtre) + 2 plateaux inox GN 1/1 + 4 accus + 4 pieds (cloches non incluses)

	cm	↑ cm
11541	60 x 41	36

verchromte Stäbe / chrome plated fittings
pies cromados / pieds chromés

GN Rolltophaube / GN rolltop cover / GN campana rolltop / GN cloche rolltop

	cm	↑ cm	GN
11008	53 x 32,5	19	1/1 Gold-Griff

GN Rolltophaube / GN rolltop cover / GN campana rolltop / GN cloche rolltop

	cm	↑ cm	GN
11010	53 x 32,5	19	1/1 Chrom-Griff

Kühlakku / cooler / acumulador de frío / accumulateur de froid

	cm	↑ cm
10791	25 x 19	2,5



11542

Buche, wasserfest lackiert
beech wood lacquered



11542



10791

**Kühl-Akkus halten Ihre Speisen
bis zu 6 Stunden kühl**
cooler keeps the food until
6 hrs. cold

Kühltablett „TOP FRESH RUND“

refrigerated buffet display
expositor buffet frío redondo
présentoir buffet



3-teilig: 1 Holzbox mit Kunststoffwanne + 1 Edelstahl-Tablett Ø 38 cm + 1 Kühlakku

3 pcs. set: 1 woodbox with plastic insert + 1 stainless tray Ø 38 cm + 1 cooler

set de 3: 1 caja madera + 1 bandeja inox Ø 38 cm + 1 acumulador de frío

set de 3: 1 base bois + 1 plateau inox Ø 38 cm + 1 accumulateur de froid

	Ø cm	↑ cm	cl
11542	48	6	

Rolltophaube / rolltop cover / campana abatible / cloche basculante

	Ø cm	↑ cm	
18388	38	20	mit verchromtem Kugelgriff

Rolltophaube / rolltop cover / campana abatible / cloche basculante

	Ø cm	↑ cm	
18387	38	20	mit vergoldetem Kugelgriff

Kühlakku / cooler / acumulador de frío / accumulateur de froid

	cm	↑ cm	
10791	25 x 19	2,5	



11543

Buche, wasserfest lackiert
beech wood lacquered



10791

**Kühl-Akkus halten Ihre Speisen
bis zu 6 Stunden kühl**
cooler keeps the food until
6 hrs. cold

Buffetvitrine „DOPPELDECKER“

double refrigerated buffet display
expositor de buffet redondo doble
présentoir buffet froid, double



11-teilig: 2 Rahmen Buchen-Holz versiegelt + 2 Edelstahl-Tablets Ø 38 cm

+ 2 Kühlakkus + 2 Kunststoffschalen + 3 Stangen, ohne Hauben

11 pcs. set: 2 beech wood boxes waterproof + 2 stainless trays Ø 38 cm

+ 2 cooler + 2 plastic deep trays + 3 fittings, without covers

set de 11: 2 bases madera + 2 bandejas inox aprox. 38cm

+ 2 acumuladores + 2 cubetas plástico + 3 varas (campanas no incl.)

set de 11: 2 caissons bois traité (hêtre) + 2 plateaux inox approx. 38 cm

+ 2 accus + 2 bacs plastique + 3 barres (cloches non incluses)

	Ø cm	↑ cm	
11543	48	38	verchromte Stäbe / chrome fittings pies cromados / pieds chromés

Rolltophaube / rolltop cover / campana abatible / cloche basculante

	Ø cm	↑ cm	
18388	38	20	mit verchromtem Kugelgriff

Rolltophaube / rolltop cover / campana abatible / cloche basculante

	Ø cm	↑ cm	
18387	38	20	mit vergoldetem Kugelgriff

Kühlakku / cooler / acumulador de frío / accumulateur de froid

	cm	↑ cm	
10791	25 x 19	2,5	

Buffet & Display



Buffetvitrine „TOP FRESH GN 1/1“

cooling buffet display
expositor buffet frío
présentoir buffet



5-teilig: 1 Edelstahl-Tablett GN 1/1 + 2 Kühllakkus + 1 Edelstahl-Schale + 1 Acrylrahmen, ohne Haube

5 pcs. set: 1 stainless tray GN 1/1 + 2 cooler + 1 stainless deep tray + 1 frame acrylic, without cover

set de 5: 1 bandeja inox GN 1/1 + 2 acumuladores + 1 cubeta inox + 1 marco metacrilato (campana no incl.)

set de 5: 1 plateau inox GN 1/1 + 2 accus. de froid + 1 bac inox + 1 cadre plexi (cloche non-incl.)

	cm	↑ cm
11510	61 x 38	8

GN Rolltophaube / GN rolltop cover / GN campana rolltop / GN cloche rolltop

	cm	↑ cm	GN
11010	53 x 32,5	19	1/1

Kühllakku / cooler / acumulador de frío / accumulateur de froid

	cm	↑ cm
10791	25 x 19	2,5



Buffetvitrine „DOPPELDECKER GN1/1“

cooling buffet display
expositor buffet frío
présentoir buffet



14-teilig: 2 Edelstahl-Tablets GN 1/1 + 4 Kühllakkus + 2 Edelstahl-Schale + 2 Acrylrahmen + 4 verchromte Stangen, ohne Hauben

14 pcs. set: 2 stainless tray GN 1/1 + 4 cooler + 2 stainless deep trays + 2 frames acrylic + 4 chrome plated fittings, without covers

set de 14: 2 bandejas inox GN 1/1 + 4 acum. de frío 2 cubetas inox + 2 bases metacrilato + 4 varas cromadas (sin las campanas)

set de 14: 2 plateaux inox GN 1/1 + 4 accus 2 bacs inox + 2 cadres plexi + 4 barres chromées (sans les cloches)

	cm	↑ cm
11514	61 x 38	33

GN Rolltophaube / GN rolltop cover / GN campana rolltop / GN cloche rolltop

	cm	↑ cm	GN
11010	53 x 32,5	19	1/1

Kühllakku / cooler / acumulador de frío / accumulateur de froid

	cm	↑ cm
10791	25 x 19	2,5



Kühltablett „TOP FRESH RUND“

cooling plate
expositor buffet frío
présentoir buffet



4-teilig: 1 Edelstahl-Tablett Ø 38 cm + 2 Kühllakkus + 1 Edelstahl-Schale + 1 Acrylrahmen, ohne Haube

4 pcs. set: 1 stainless tray Ø 38 cm + 2 cooler + 1 stainless deep tray + 1 frame acrylic, without cover

set de 4: 1 bandeja inox 38cm + 2 acum. de frío + 1 cubeta inox + 1 base metacrilato (campana no incluida)

set de 4: 1 plateau inox 38cm + 2 accum. de froid + 1 bac inox + 1 base plexi (cloche non incl.)

	Ø cm	↑ cm
11512	43,5	8

Rolltophaube / rolltop cover / campana abatible / cloche basculante

	Ø cm	↑ cm	
18388	38	20	mit verchromtem Kugelgriff

Kühllakku / cooler / acumulador de frío / accumulateur de froid

	cm	↑ cm	pcs.
11101	16 x 7,5	2	4



Buffetvitrine „DOPPELDECKER“

cooling plate
expositor de buffet doble redondo
présentoir buffet



13-teilig: 2 Edelstahl-Tablets Ø 38 cm + 4 Kühllakkus + 2 Edelstahl-Schalen + 2 Acrylrahmen + 3 verchromte Stangen, ohne Hauben

13 pcs. set: 2 stainless trays Ø 38 cm + 4 cooler + 2 stainless deep tray + 2 frames acrylic + 3 chrome plated fittings, without covers

set de 13: 2 bandejas inox 38 cm + 4 acumuladores de frío + 3 varas cromadas + 2 bases + 2 bandejas, campana no incluida

set de 13: 2 plateaux inox 38cm + 4 accum. de froid + 2 bacs inox + 2 bases plexi + 3 barres chromées (cloche non incl.)

	Ø cm	↑ cm
11516	43,5	33

Rolltophaube / rolltop cover / campana abatible / cloche basculante

	Ø cm	↑ cm	
18388	38	20	mit verchromtem Kugelgriff

Kühllakku / cooler / acumulador de frío / accumulateur de froid

	cm	↑ cm	pcs.
11101	16 x 7,5	2	4

Buffet & Display



Kühlbox „TOP FRESH GN 1/1“

cooling plate
bandeja de frío
présentoir buffet réfrigéré



4-teilig: 1 Kühlbox + 1 Tablett GN 1/1 + 2 Kühlakkus, ohne Haube

4 pcs. set: 1 box + 1 tray GN 1/1 + 2 coolers, without cover

set de 4: 1 caja plástico blanco + 1 bandeja GN 1/1 + 2 acum. de frío, campana no incluida

set de 4: 1 caisson plastique blanc + 1 plateau GN 1/1 + 2 accum. de froid, cloche non incl.

	cm	↑ cm	Farbe / Colour
11503	56,5 x 35	6,5	White
11505	56,5 x 35	6,5	Black

GN Rolltophaube / GN rolltop cover / GN campana rolltop / GN cloche rolltop

	cm	↑ cm	GN
11008	53,0 x 32,5	19	1/1 mit vergoldetem Kreuzgriff

GN Rolltophaube / GN rolltop cover / GN campana rolltop / GN cloche rolltop

	cm	↑ cm	GN
11010	53 x 32,5	19	1/1 mit verchromtem Kreuzgriff

Kühlakku / cooler / acumulador de frío / accumulateur de froid

	cm	↑ cm
10791	25 x 19	2,5

GN Edelstahl-Tablett „PROFI LINE“ / GN tray / GN bandeja / GN plat empilable système catering

	cm	↑ cm	GN
11100	53 x 32,5	1,5	1/1



Kühlbox „TOP FRESH GN 1/1“

cooling box
expositor buffet frío
présentoir buffet



4-teilig: 1 Kühlbox + Tablett GN 1/1 + 2 Kühlakkus, ohne Haube

4 pcs. set: 1 box + 1 tray GN 1/1 + 2 cooler, without rolltop cover

set de 4: 1 cajón + 1 bandeja GN 1/1 + 2 enfriadores, campana no incluida

set de 4: 1 caisson inférieur + 1 plateau GN 1/1 + 2 accus, cloche non incluse

	cm	↑ cm
11590	56,5 x 36	8,5

GN Rolltophaube / GN rolltop cover / GN campana rolltop / GN cloche rolltop

	cm	↑ cm	GN
11008	53 x 32,5	19	1/1

GN Rolltophaube / GN rolltop cover / GN campana rolltop / GN cloche rolltop

	cm	↑ cm	GN
11010	53 x 32,5	19	1/1

Kühlakku / cooler / acumulador de frío / accumulateur de froid

	cm	↑ cm
10791	25 x 19	2,5



18388

11538

10791

Kühl-Akkus halten Ihre Speisen bis zu 6 Stunden kühl
cooler keeps the food until 6 hrs. cold

Kühlbox „TOP FRESH SET“

cooling plate
bandeja de frío
set frigifère



3-teilig: 1 Box + 1 Tablett Ø 38 cm + 1 Kühllakku, ohne Haube
3 pcs. set: 1 box + 1 tray Ø 38 cm + 1 cooler, without cover
set de 3: 1 caja + 1 bandeja Ø 38 cm + 1 enfriador, sin tapa
set de 3: 1 caisson + 1 plateau Ø 38 cm + 1 accum. (livré sans la cloche)

	Ø cm	↑ cm	Farbe / Colour
11538	42	6	
11533	42	6	

Rolltophaube / rolltop cover / campana abatible / cloche basculante

	Ø cm	↑ cm	
18388	38	20	mit verchromtem Kugelgriff

Kühllakku / cooler / acumulador de frío / accumulateur de froid

	cm	↑ cm	
10791	25 x 19	2,5	



18388

09082

11101

Kühl-Akkus halten Ihre Speisen bis zu 6 Stunden kühl
cooler keeps the food until 6 hrs. cold

Thermo-Set

thermo set
bandeja isotérmica
set thermo



5-teilig: 1 Tablett tief + 1 Tablett flach + 2 Kühllakkus + 1 Rolltophaube
5 pcs. set: 1 deep tray + 1 tray + 2 cooler + 1 rolltop cover
set de 5: 1 bandeja inferior + 1 bandeja + 2 acumuladores frío + campana
set de 5: 1 plateau creux + 1 plateau plat + 2 accum. + 1 cloche rolltop

	Ø cm	↑ cm	
09082	38	24	

Rolltophaube / rolltop cover / campana abatible / cloche basculante

	Ø cm	↑ cm	
18388	38	20	mit verchromtem Kugelgriff

Kühllakku / cooler / acumulador de frío / accumulateur de froid

	cm	↑ cm	pcs.
11101	16 x 7,5	2	4



09083

11101

Kühl-Akkus halten Ihre Speisen bis zu 6 Stunden kühl
cooler keeps the food until 6 hrs. cold

Thermo-Set

thermo set
porta tartas refrigerado
porte-gâteau réfrigéré



4-teilig: 1 Tablett tief auf Fuß + 1 Tablett flach + 2 Kühllakkus
4 pcs. set: 1 deep tray with feet + 1 tray + 2 cooler
set de 4: 1 bandeja honda con pie + 1 bandeja + 2 acumuladores de frío
set de 4: 1 plateau creux avec pied + 1 plateau plat + 2 accum.

	Ø cm	↑ cm	
09083	38	14,5	

Rolltophaube / rolltop cover / campana abatible / cloche basculante

	Ø cm	↑ cm	
18388	38	20	mit verchromtem Kugelgriff

Kühllakku / cooler / acumulador de frío / accumulateur de froid

	cm	↑ cm	pcs.
11101	16 x 7,5	2	4

Buffet & Display



Kühlschale Mini Holz „TOP FRESH“

cool bowl mini holz
bol refrigerado mini madera
bol réfrigéré MINI bois

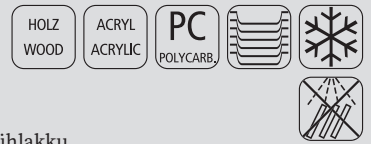

4-teilig: 1 Fuß Buchen-Holz versiegelt + 1 Schale + 1 Kühlakku
+ 1 klappbarer Deckel mit Beschriftungsschild

4 pcs. set: 1 column with food base (beech) + 1 bowl
+ 1 cooler + 1 cover with card, hinged

set de 4: 1 bol polycarbonato + 1 base madera
+ 1 acum. de frío + 1 tapa con bisagra y porta etiqueta

set de 4 : 1 base en bois + 1 accum + 1 bol polycarbonate
+ 1 couvercle à charnière avec porte-étiquette

	Ø cm	↑ cm	ltr.
11812	14	9,0	0,6
11813	14	11,5	1,0

Ersatzschale / spare bowl / recambio bol / bol de rechange

	Ø cm	↑ cm
11811	14	6,5
11816	14	9,0

Schutzdeckel mit Löffelaussparung / cover / tapa / couvercle

	Ø cm
11868	14,5

Kühlakku / cooler / acumulador de frío / accumulateur de froid

	Ø cm	↑ cm
10661	10,5	2



Kühlschale Maxi Holz „TOP FRESH“

cool bowl maxi holz
bol refrigerado MAXI madera
bol réfrigéré MAXI bois

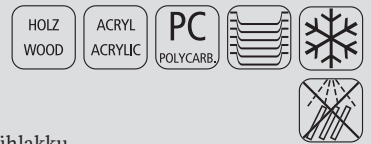

4-teilig: 1 Fuß Buchen-Holz versiegelt + 1 Schale + 1 Kühlakku
+ 1 klappbarer Deckel mit Beschriftungsschild

4 pcs. set: 1 column with food base (beech) + 1 bowl
+ 1 cooler + 1 cover with card, hinged

set de 4: 1 bol + 1 base madera + 1 acumulador de frío
+ 1 tapa con bisagra y porta etiqueta

set de 4: 1 base en bois + 1 accum. + 1 bol
+ 1 couvercle à charnière avec porte-étiquette

	Ø cm	↑ cm	ltr.
11817	22	14	2,5
11818	22	18	4,0

Ersatzschale / spare bowl / recambio bol / bol de rechange

	Ø cm	↑ cm
11846	22	8
11848	22	12

Schutzdeckel mit Löffelaussparung / cover / tapa / couvercle

	Ø cm
11878	23,5

Kühlakku / cooler / acumulador de frío / accumulateur de froid

	Ø cm	↑ cm
10777	15	2,5



Kühlschale Mini „TOP FRESH“

cool bowl mini
bol refrigerado MINI
bol réfrigéré MINI



4-teilig: 1 Edelstahlgefäß matt + 1 Kühlakku + 1 Schale + 1 klappbarer Deckel mit Beschriftungsschild

4 pcs. set: 1 column satin polished finish + 1 cooler + 1 bowl + 1 cover with card, hinged

set de 4: 1 base acabado efecto satinado + 1 acumulador de frío + 1 tapa con porta etiqueta + 1 bol

set de 4: 1 base inox mat satiné + 1 accum. de froid + 1 couvercle à charnière avec porte étiquette + 1 bol

	Ø cm	↑ cm	ltr.
11810	14	9,0	0,6
11815	14	11,5	1,0

Ersatzschale / spare bowl / recambio bol / bol de rechange

	Ø cm	↑ cm
11811	14	6,5
11816	14	9,0

Schutzdeckel mit Löffelaussparung / cover / tapa / couvercle

	Ø cm
11868	14,5

Kühlakku / cooler / acumulador de frío / accumulateur de froid

	Ø cm	↑ cm
10661	10,5	2



Kühlschale Maxi „TOP FRESH“

cool bowl maxi
bol refrigerado MAXI
bol réfrigéré MAXI



4-teilig: 1 Gefäß hochglanzpoliert + 1 Kühlakku + 1 Schale + 1 klappbarer Deckel mit Beschriftungsschild

4 pcs. set: 1 column mirror polished finish + 1 cooler + 1 bowl + 1 cover with card, hinged

set de 4: 1 base pulido acabado efecto espejo + 1 acumulador de frío + 1 tapa con porta etiqueta + 1 bol

set de 4: 1 base inox poli brillant + 1 accum. + 1 récipient + 1 couvercle à charnière avec porte-étiquette

	Ø cm	↑ cm	ltr.
11847	22	14	2,5
11849	22	18	4,0

Ersatzschale / spare bowl / recambio bol / bol de rechange

	Ø cm	↑ cm
11846	22	8
11848	22	12

Schutzdeckel mit Löffelaussparung / cover / tapa / couvercle

	Ø cm
11878	23,5

Kühlakku / cooler / acumulador de frío / accumulateur de froid

	Ø cm	↑ cm
10777	15	2,5



11845
2,5 ltr.

11875

Kühlschale Maxi „TOP FRESH“

cool bowl maxi
cuenco refrigerado MAXI
bol réfrigéré MAXI



4-teilig: 1 Gefäß hochglanzpoliert + 1 Kühlakku + 1 Glasschale
+ 1 klappbarer Deckel mit Beschriftungsschild

4 pcs. set: 1 column mirror polished finish + 1 cooler
+ 1 glass bowl + 1 cover with card, hinged

set de 4: 1 base pulido acabado efecto espejo
+ 1 acumulador de frío + 1 tapa con porta etiqueta + 1 bol vidrio

set de 4 : 1 base inox poli brillant + 1 accum.
+ 1 bol verre + 1 couvercle à charnière avec porte-étiquette

	Ø cm	↑ cm	ltr.
11845	23	14	2,5

Schale / bowl / cuenco / bol

	Ø cm	↑ cm	ltr.
11875	23	10,5	2,5

Schutzdeckel mit Löffelaussparung / cover / tapa / couvercle

	Ø cm
11878	23,5

Kühlakku / cooler / acumulador de frío / accumulateur de froid

	Ø cm	↑ cm
10777	15	2,5



83696

83705

83920

Schale „CASUAL MAXI“

bowl
cuenco
bol



	Ø cm	↑ cm	ltr.	Farbe / Colour
83696	10	4,5	0,15	White
83698	12	5,5	0,25	White
83700	14	6,5	0,50	White
83704	20	9,2	1,80	White
83702	23	10,5	2,50	White

	Ø cm	↑ cm	ltr.	Farbe / Colour
83697	10	4,5	0,15	Black
83699	12	5,5	0,25	Black
83701	14	6,5	0,50	Black
83705	20	9,2	1,80	Black
83703	23	10,5	2,50	Black

Deckel „FLOAT“ mit Löffelaussparung / cover, with notched for spoons / tapa, con espacio para la cuchara / couvercle, avec encoche pour la louche

	Ø cm	↑ cm	fits to
83920	20,5	1,3	83704, 83705



1,0 ltr. and 1,2 ltr.

Glaskaraffe

glass carafe
jarra de vidrio
carafe en verre



Deckel aus Edelstahl matt poliert
lid made of matt polished stainless steel
tapa de acero inoxidable pulido mate,
couvreclre en acier inox poli mat

	Ø cm	↑ cm	ltr.
10721	8	25	1,0
10722	8	32	1,2



Ausgießer für tropffreies Ausgießen
spout for drip-free pouring



0,8 ltr.

Glaskaraffe „ICEBLUE“

glass carafe
jarra de vidrio
carafe en verre

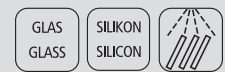

	Ø cm	↑ cm	ltr.
10723	8	30	0,8



inkl. Stopfen mit Silikondichtung
incl. stopper with silicone gasket



1,5 ltr.

Glaskaraffe

glass carafe
jarra de vidrio
carafe en verre



Deckel aus Edelstahl matt poliert, mit integriertem Auffangsieb für Kerne oder Eis
lid made of matt polished stainless steel, with integrated strainer for cores or ice
tapa de acero inoxidable pulido mate, con filtro integrado para los huesos o el hielo
couvreclre en acier inox poli mat, avec filtre intégré pour les pépins ou la glace

	Ø cm	↑ cm	ltr.
10792	10	26	1,5



Deckel mit Doppelfunktion
Lid with double function



1,6 ltr.

Glaskaraffe

glass carafe
jarra de vidrio
carafe en verre



	Ø cm	↑ cm	ltr.
10745	11	25,5	1,6

Buffet & Display



Glaskaraffe „LINES“

glass carafe
jarra de vidrio
carafe en verre

GLAS
GLASS

KORK
CORK



	Ø cm	↑ cm	ltr.
10738	8	27	0,9



Detailansicht
detail view „LINES“



inkl. Korkdeckel
incl. cork cover



Glaskaraffe „DOTS“

glass carafe
jarra de vidrio
carafe en verre

GLAS
GLASS

KORK
CORK



	Ø cm	↑ cm	ltr.
10739	8	27	0,9



Detailansicht
detail view „DOTS“



inkl. Korkdeckel
incl. cork cover



Glaskaraffe „WABE“

glass carafe
jarra de vidrio
carafe en verre

GLAS
GLASS



	Ø cm	↑ cm	ltr.
10741	8	28	0,8



HOLZ
WOOD

SILIKON
SILICON

inkl. Holzkorken mit Silikondichtung
incl. wooden cork with silicone gasket



Glaskaraffe „DIAMOND“

glass carafe
jarra de vidrio
carafe en verre

GLAS
GLASS



	Ø cm	↑ cm	ltr.
10742	8	28	0,8



HOLZ
WOOD

SILIKON
SILICON

inkl. Holzkorken mit Silikondichtung
incl. wooden cork with silicone gasket



Glaskaraffe „RINGS“

glass carafe
jarra de vidrio
carafe en verre



	Ø cm	↑ cm	ltr.
10743	8	28	0,8



HOLZ
WOOD

SILIKON
SILICON

inkl. Holzkorken mit Silikondichtung
incl. wooden cork with silicone gasket



Flasche „STRIPES“

bottle
botella
bouteille



	Ø cm	↑ cm	ltr.
10748	9	28,5	1



Flasche „STRIPES“

bottle
botella
bouteille



	Ø cm	↑ cm	ltr.
10749	9	28,5	1



Kühlkaraffe, 3-teilig „COOL“

cooling carafe, 3 pcs. set
jarra fría, set de 3
pichet rafraichisseur, set 3



1 Glaskaraffe mit Edelstahl-Ausgießer, öffnet und schließt selbstständig
+ 1 verchromter Fuß + 1 Kühlakku, werden bis zu 4 Stunden gekühlt
1 glass carafe with stainless steel pourer, open / closing autonomous
+ 1 chrome plated base + 1 cooling pack, up to 4 hours cooled beverages
1 botella de vidrio con vertedor inox y silicona, con autocierre
+ 1 base cromada + 1 placa de frío que mantiene las bebidas frescas hasta unas 4 horas
pichet en verre avec insert verseur inox et silicone, fermeture automatique
+ socle chromé + accumulateur de froid pour maintenir les boissons froides jusqu'à 4 heures

	Ø cm	↑ cm	ltr.
10762	16	27	1,4

Glasflasche / glass carafe / jarra de vidrio / pichet verre

	Ø cm	↑ cm
10761	16	26

Kühlakku rund, schwarz / cooler round, black / cooler / accumulateur de froid, noir

	Ø cm	↑ cm
10752	10,5	2

Buffet & Display



Glaskaraffe

glass carafe
jarra
pichet en verre



der Deckel öffnet sich beim Ausgießen automatisch
cover opens automatically while pouring
la tapa se abre automáticamente durante el vertido
le couvercle s'ouvre seul pendant le service, résistant à la chaleur

	Ø cm	↑ cm	ltr.
10766	9,5	29	1



Glaskaraffe

glass carafe
jarra
pichet verre



Deckel aus Edelstahl matt poliert
stainless steel cover
tapa de acero inoxidable
couvercle inox



Ausgießer für tropffreies ausgießen
spout for drip-free pouring

	Ø cm	↑ cm	ltr.
10764	9,5	27	1,5



Saft- / Wasserkanne

juice / water pitcher
jarra de zumo / agua
pichet à eau ou jus de fruit



mit Eiswasser-Röhre
with water ice tube
con tubo para hielo
avec tube à glaçons plongeant pour réfrigérer

	cm	↑ cm	ltr.
10769	19 x 13	27	2,8



Saftkanne

juice pitcher
jarra de zumo
pichet à jus de fruit



mit Eiswasser-Röhre
with water ice tube
con tubo para hielo
avec tube à glaçons plongeant pour réfrigérer

	Ø cm	↑ cm	ltr.
10770	18	29	3



Saftkanne
juice pitcher
jarra de zumo
pichet à jus de fruit



	Ø cm	↑ cm	ltr.
10775	12	26	2



Saftkanne
juice pitcher
jarra de zumo
pichet à jus de fruit



	Ø cm	↑ cm	ltr.
10776	14	29	2,5



Pitcher
pitcher
jarra
pichet



	Ø cm	↑ cm	ltr.
93105	13	21	1,5



Karaffe / Kanne
bottle
botella
bouteille



Schraubdeckel mit aromadichtem Verschluss
screwed lid, aroma-tight
tapón de rosca, impide la fuga de aromas
bouchon à visser, ne laisse pas passer les arômes

	Ø cm	↑ cm	ltr.	Farbe / Colour
10771	11	30	1,6	
10772	11	30	1,6	
10773	11	30	1,6	
10774	11	30	1,6	

Buffet & Display



Kühlbox „FROSTY“

bottle cooler
enfriador de botellas
rafraichisseur de bouteilles

mit herausnehmbarem Einsatz für 4 Flaschen

with removable insert for 4 bottles
con inserto extraíble para 4 botellas
avec insert amovible pour 4 bouteilles



Abb. ohne Einsatz
illustration without insert

	cm	↑ cm	ltr.	hole ø cm
93230	27 x 27	15	7,5	11



Wein- / Sektkühler

wine / champagne bowl
cubitera para vino y cava
seau à vin ou champagne

gehämmerte Oberfläche mit 2 seitlichen Eingriffen

hammered surface with 2 handles on the side
superficie martillada con 2 asas
surface martelée avec 2 poignées



	cm	↑ cm	ltr.	Farbe / Colour
36111	30 x 23,5	23	7	copper-look



Wein- / Sektkühler

wine / champagne bowl
cubitera para vino y cava
seau à vin ou champagne

gehämmerte Oberfläche mit 2 seitlichen Eingriffen

hammered surface with 2 handles on the side
superficie martillada con 2 asas
surface martelée avec 2 poignées



	cm	↑ cm	ltr.	Farbe / Colour
36112	30 x 23,5	23	7	gunmetal-look



Getränkewanne „TIN“

beverage tub
barreño botellines
bassine à glace

Metall verzinkt, mit Kunststoffeinsatz

galvanised metal, with plastic insert
metal galvanizado, con inserto de plástico
métal galvanisé, avec insert en plastique



	Ø cm	↑ cm	ltr.	Farbe
36100	40 x 28	22	11	copper-look
36101	40 x 28	22	11	black-metal-look



mit Kunststoffeinsatz
with plastic insert
con inserto de plástico
avec insert en plastique



Kreidestift zum Beschriften
chalk marker for writing
S. 312



10328

Milch- / Universalkanne

milk / water jug
jarra leche / agua
pichet à eau / lait



außen hochglanzpoliert, innen matt poliert
outside mirror polished finish, inside satin polished finish
exterior brillante, interior satinado
extérieur brillant, intérieur mat satiné

	Ø cm	↑ cm	ltr.
10328	8,0	10,0	0,35
10329	9,0	11,5	0,60
10330	10,5	13,0	0,80
10331	12,0	16,5	1,30
10332	13,5	18,0	2,00



10334

Milch-/Universalkanne „ANTIHAFT“

non stick jug
jarra antiadherente
pichet antiadhésif



PTFE-antihftbeschichtet, perfekt für die Herstellung von Milchschaum
PTFE coated, for baristas frothing hot milk
revestimiento PTFE, ideal para espume de leche
revêtement PTFE, idéal pour faire mousser le lait

	Ø cm	↑ cm	ltr.
10334	8,0	10,0	0,35
10335	9,0	11,5	0,6
10336	10,5	13,0	0,8



Teebrühsieb

snap mesh tea ball
infusor de té, pinza con malla
boule à thé avec pince



matt poliert, mit feinem Sieb, aufklappbar
satin polished finish, with fine mesh, hinged
acabado pulido efecto satinado, con malla fina, con bisagra
inox mat, maille fine, avec charnière

	Ø cm	→ cm
74750	4,5	15,5



0,3 ltr.

Teekanne „ASIA“

teapot
tetera
théière



aus Gusseisen, innen emailliert, hält den Tee lange warm, kein nachbittern, ideal für zwei Tassen
made of cast iron, keeps the tea warm for a long time, no bitterness, ideal for two cups
hecho de hierro fundido, mantiene el té caliente durante mucho tiempo, sin amargar, ideal para dos tazas
en fonte, maintient le thé chaud pendant longtemps, pas d'amertume, idéal pour deux tasses

	cm	↑ cm	ltr.
10990	12,5 x 11	12,5	0,3

BEVERAGE DISPENSERS



Getränkespender „OLD FASHIONED“

beverage dispenser
dispensador de bebidas
distributeur de boissons



dicke, stabile Wände, weite Öffnung für große Zutaten, Gestell schwarz
thick, stable walls, a wide opening for large ingredients, black stand
tiene paredes gruesas y estables, amplia abertura para ingredientes grandes, soporte negro
des murs épais et stables, large ouverture pour de grands ingrédients, support noir

	Ø cm	↑ cm	ltr.	
10409	27	50,5	7	inkl. Gestell / incl. stand

Ersatz-Gestell zu Getränkenspender / stand for beverage dispenser / soporte de recambio para el dispensador de bebidas / support de remplacement pour le distributeur de boissons

	Ø cm	↑ cm	
10410	27	31,5	

Ersatz-Glas zu Getränkenspender ohne Zapfhahn / replacement glass for beverage dispenser without tap / cristal de recambio para el dispensador de bebidas sin grifo / vitre de rechange pour le distributeur de boissons sans robinet

	Ø cm	↑ cm	ltr.
10411	19	36,5	7

Ersatz-Zapfhahn zu Getränkenspender / replacement tap for beverage dispenser

10718



Getränkespender „ASIA“

beverage dispenser
dispensador de bebidas
distributeur de boissons



dicke, stabile Wände, weite Öffnung für große Zutaten, Fuß und Deckel aus Holz
thick, stable walls, a wide opening for large ingredients, wooden stand and lid
tiene paredes gruesas y estables, amplia abertura para ingredientes grandes, soporte y tapa de madera
des murs épais et stables, large ouverture pour de grands ingrédients, support et couvercle en bois

	Ø cm	↑ cm	ltr.	
10403	24,5	45,5	7	inkl. Gestell / incl. stand

Ersatz-Fuß zu Getränkenspender mit Anti-Rutsch-Füßchen / base to beverage dispenser with non slip feet / soporte de recambio para el dispensador de bebidas con pies antideslizantes / support de remplacement pour le distributeur de boissons avec pieds antidérapants

	Ø cm	↑ cm	
10404	24,5	15	

Ersatz-Deckel zu Getränkenspender / replacement lid for beverage dispenser / tapa de recambio para el dispensador de bebidas / couvercle de rechange pour le distributeur de boissons

	Ø cm	↑ cm	
10405	14,0	5	



7 ltr.

Getränkespender „ELEMENT“

beverage dispenser
dispensador de bebidas
distributeur de boissons



dicke, stabile Wände, weite Öffnung für große Zutaten, Fuß und Deckel aus Beton
thick, stable walls, a wide opening for large ingredients, stand and lid made of concrete
tiene paredes gruesas y estables, amplia abertura para ingredientes grandes, soporte y tapa de hormigón
des murs épais et stables, large ouverture pour de grands ingrédients, support et couvercle en béton

	Ø cm	↑ cm	litr.	
10400	22	45	7	inkl. Gestell / incl. stand

Ersatz-Fuß zu Getränkenspender mit Anti-Rutsch-Füßchen / base to beverage dispenser with non slip feet / soporte de recambio para el dispensador de bebidas con pies antideslizantes / support de remplacement pour le distributeur de boissons avec pieds antidérapants

	Ø cm	↑ cm
10401	22	17

Ersatz-Deckel zu Getränkenspender / replacement lid for beverage dispenser / tapa de recambio para el dispensador de bebidas / couvercle de rechange pour le distributeur de boissons

	Ø cm	↑ cm
10402	14	2,5



6 ltr.

Getränkespender „GINGER“

beverage dispenser
dispensador de bebidas
distributeur de boissons



weite Öffnung für große Zutaten, 1 Kühlakku im Standfuß
wide opening for large ingredients, 1 cooler in the base
amplia abertura para ingredientes grandes, 1 acumulador de frío en la base
large ouverture pour de grands ingrédients, 1 accumulateur de froid dans le socle

	Ø cm	↑ cm	litr.	
10406	20	49,5	6	inkl. Gestell / incl. stand

Ersatz-Fuß zu Getränkenspender mit Anti-Rutsch-Füßchen
base to beverage dispenser with non slip feet
soporte de recambio para el dispensador de bebidas con pies antideslizantes
support de remplacement pour le distributeur de boissons avec pieds antidérapants

	Ø cm	↑ cm
10407	18	13,5

Ersatz-Deckel zu Getränkenspender / replacement lid for beverage dispenser / tapa de recambio para el dispensador de bebidas / couvercle de rechange pour le distributeur de boissons

	Ø cm	↑ cm
10408	20	7,5

Kühlakku / cooler / acumulador de frío / accumulateur de froid

	Ø cm	↑ cm
10777	15	2,5

Behälter inkl. Zapfhahn / container incl. tap / recipiente con grifo / récipient avec robinet

	litr.
10703	6

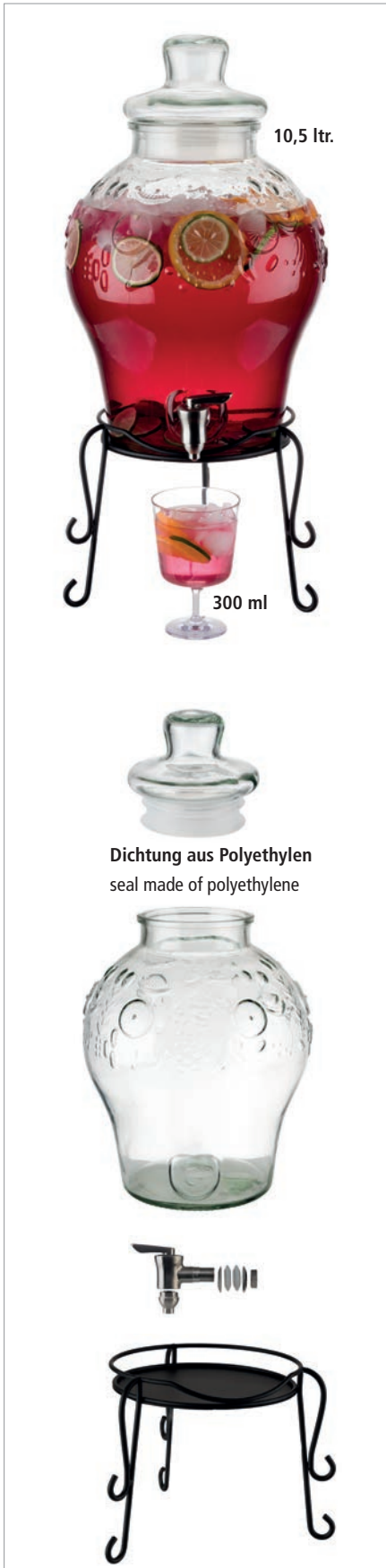

10,5 ltr.

300 ml

Dichtung aus Polyethylen
seal made of polyethylene

300 ml

Getränkespender „FRUITS“

beverage dispenser
dispensador de bebidas
distributeur de boissons



dicke, stabile Wände, weite Öffnung für große Zutaten, Gestell schwarz
thick, stable walls, a wide opening for large ingredients, black stand
tiene paredes gruesas y estables, amplia abertura para ingredientes grandes, soporte negro
des murs épais et stables, large ouverture pour de grands ingrédients, support noir

	Ø cm	↑ cm	ltr.	
10415	25	58	10,5	inkl. Gestell / incl. stand

Trinkglas „BEACH“

drinking glass / vaso / verre



	Ø cm	↑ cm	ltr.	VE
10505	8,5	13,5	0,3	48

Ersatzteile Getränkespender „FRUITS“

spare parts beverage dispenser
recambios dispensador de bebidas
pièces distributeur de boissons

Ersatz-Deckel zu Getränkespender „FRUITS“

replacement glass for beverage dispenser / cristal de recambio
para el dispensador de bebidas / vitre de rechange pour le
distributeur de boissons



	Ø cm	↑ cm
10418	14	12

Ersatz-Glas zu Getränkespender „FRUITS“ inkl. Deckel, ohne Zapfhahn

replacement glass for beverage dispenser without tap
cristal de recambio para el dispensador de bebidas sin grifo
vitre de rechange pour le distributeur de boissons sans robinet

	Ø cm	↑ cm	ltr.
10417	25	42	10,5

Ersatz-Zapfhahn zu Getränkespender

replacement tap for beverage dispenser
grifo de recambio para el dispensador de bebidas
robinet de rechange pour le distributeur de boissons



10718

Ersatz-Gestell zu Getränkespender

stand for beverage dispenser
soporte de recambio para el dispensador de bebidas
support de remplacement pour le distributeur de boissons



	Ø cm	↑ cm
10416	26	19

Trinkglas „OLD FASHIONED“

drinking cup
vaso
gobelet



	Ø cm	↑ cm	ltr.	VE
10520	7	12,5	0,3	6



4,5 ltr.

300 ml



Glas inkl. Zapfhahn



Getränkespender „FRESH WHITE“

beverage dispenser
dispensador de bebidas
distributeur de boissons

Behälter mit Edelstahlzapfhahn und Holzdeckel, stabiles Glas,
inkl. weißem Holzstandfuß und Kork-Untersetzer

container with stainless steel tap and wooden cover, solid glass,
incl. white wooden base and cork coaster

recipiente con grifo de acero inoxidable y tapa de madera, cristal sólido,
incl. pie de madera blanca y posavasos de corcho

réceptif avec robinet en acier inox et couvercle en bois, verre robuste,
incl. pied en bois blanc et soucoupes de liège

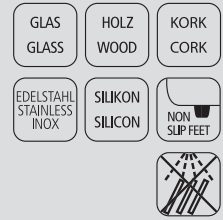

	cm	↑ cm	ltr.	
10420	23 x 23	56,5	4,5	inkl. Gestell / incl. stand

Trinkbecher „CRYSTAL“ drinking cup / vaso / gobelet



	Ø cm	↑ cm	ltr.	VE
10501	8	12,5	0,3	48

Ersatzteile Getränkenspender „FRESH WHITE“

spare parts beverage dispenser
recambios dispensador de bebidas
pièces distributeur de boissons

Ersatz-Deckel zu Getränkenspender „FRESH WHITE“

replacement lid for beverage dispenser
tapa de recambio para el dispensador de bebidas
couvercle de rechange pour le distributeur de boissons



	Ø cm	↑ cm	Farbe / Colour
10423	11,5	1,5	_____

Ersatz-Glas zu Getränkenspender „FRESH WHITE“, inkl. Zapfhahn

replacement glass for beverage dispenser with tap
cristal de recambio para el dispensador de bebidas con grifo
vitre de rechange pour le distributeur de boissons avec robinet



	Ø cm	↑ cm	ltr.
10422	15,5	42,0	4,5

Ersatz-Untersetzer aus Kork zu Getränkenspender „FRESH WHITE“

replacement cork coaster for beverage dispenser
posavasos de corcho de recambio para el dispensador de bebidas
soucoupes de liège de rechange pour le distributeur de boissons



	Ø cm	↑ cm
10424	16,5	1,5

Ersatz-Gestell zu Getränkenspender „FRESH WHITE“

stand for beverage dispenser
soporte de recambio para el dispensador de bebidas
support de remplacement pour le distributeur de boissons



	cm	↑ cm	Farbe / Colour
10421	23 x 23	14	_____



Getränkespender „FRESH WOOD“

beverage dispenser
dispensador de bebidas
distributeur de boissons

Behälter mit Edelstahlzapfhahn und Korkdeckel, stabiles Glas,
inkl. Holzstandfuß und Kork-Untersetzer

container with stainless steel tap and cork cover, solid glass,
incl. wooden base and cork coaster

recipiente con grifo de acero inoxidable y tapa de corcho, cristal sólido,
incl. pie de madera y posavasos de corcho

réceptif avec robinet en acier inox et couvercle de liège, verre robuste,
incl. pied en bois et soucoupes de liège

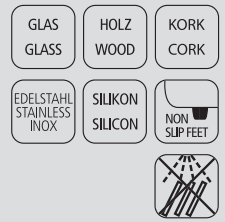

	cm	↑ cm	ltr.	
10430	23 x 23	56,5	4,5	inkl. Gestell / incl. stand

Trinkbecher „CRYSTAL“
drinking cup / vaso / gobelet



	Ø cm	↑ cm	ltr.	VE
10501	8	12,5	0,3	48

Tropfenschale
drip tray
aro anti-goteo
anneau coupe-gouttes



	Ø cm	↑ cm	Farbe / Colour
10851	9,5	1,5	

Ersatzteile Getränkspender „FRESH WOOD“

spare parts beverage dispenser
recambios dispensador de bebidas
pièces distributeur de boissons

Ersatz-Deckel zu Getränkspender „FRESH WOOD“
replacement lid for beverage dispenser
tapa de recambio para el dispensador de bebidas
couvercle de rechange pour le distributeur de boissons



	Ø cm	↑ cm	Farbe / Colour
10428	11,5	1,5	

Ersatz-Glas zu Getränkspender „FRESH WOOD“, inkl. Zapfhahn
replacement glass for beverage dispenser with tap
cristal de recambio para el dispensador de bebidas con grifo
vitre de rechange pour le distributeur de boissons avec robinet



	Ø cm	↑ cm	ltr.
10422	15,5	42,0	4,5

Ersatz-Untersetzer aus Kork zu Getränkspender „FRESH WOOD“
replacement cork coaster for beverage dispenser
posavasos de corcho de recambio para el dispensador de bebidas
soucoupes de liège de rechange pour le distributeur de boissons



	Ø cm	↑ cm
10424	16,5	1,5

Ersatz-Gestell zu Getränkspender „FRESH WOOD“
stand for beverage dispenser
soporte de recambio para el dispensador de bebidas
support de remplacement pour le distributeur de boissons



	cm	↑ cm	Farbe / Colour
10426	23 x 23	14	



7,5 ltr.

300 ml



7,5 ltr.

Glas inkl. Zapfhahn



Getränkespender „NORDIC WHITE“

beverage dispenser
dispensador de bebidas
distributeur de boissons

Behälter mit Edelstahlzapfhahn und Holzdeckel, stabiles Glas,
inkl. weißem Holzstandfuß und Kork-Untersetzer

container with stainless steel tap and wooden cover, solid glass,
incl. white wooden base and cork coaster

recipiente con grifo de acero inoxidable y tapa de madera, cristal sólido,
incl. pie de madera blanca y posavasos de corcho

réceptif avec robinet en acier inox et couvercle en bois, verre robuste,
incl. pied en bois blanc et soucoupes de liège

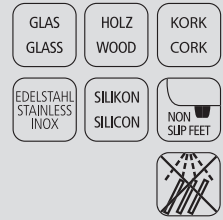

	cm	↑ cm	ltr.	
10425	23 x 23	60,5	7,5	inkl. Gestell / incl. stand

Trinkbecher „CRYSTAL“ drinking cup / vaso / gobelet



	Ø cm	↑ cm	ltr.	VE
10501	8	12,5	0,3	48

Tropfenschale drip tray aro anti-goteo anneau coupe-gouttes



	Ø cm	↑ cm	Farbe / Colour
10851	9,5	1,5	_____

Ersatzteile Getränkespender „NORDIC WHITE“

spare parts beverage dispenser
recambios dispensador de bebidas
pièces distributeur de boissons

Ersatz-Deckel zu Getränkespender „NORDIC WHITE“
replacement lid for beverage dispenser
tapa de recambio para el dispensador de bebidas
couvercle de rechange pour le distributeur de boissons avec robinet



	Ø cm	↑ cm	Farbe / Colour
10423	11,5	1,5	_____

Ersatz-Glas zu Getränkespender „NORDIC WHITE“, inkl. Zapfhahn
replacement glass for beverage dispenser with tap
cristal de recambio para el dispensador de bebidas con grifo
vitre de rechange pour le distributeur de boissons avec robinet



	Ø cm	↑ cm	ltr.
10427	17	46	7,5

Ersatz-Untersetzer aus Kork zu Getränkespender „NORDIC WHITE“
replacement cork coaster for beverage dispenser
posavasos de corcho de recambio para el dispensador de bebidas
soucoupes de liège de rechange pour le distributeur de boissons



	Ø cm	↑ cm
10424	16,5	1,5

Ersatz-Gestell zu Getränkespender „NORDIC WHITE“
stand for beverage dispenser
soporte de recambio para el dispensador de bebidas
support de remplacement pour le distributeur de boissons



	cm	↑ cm	Farbe / Colour
10421	23 x 23	14	_____



7,5 ltr.

300 ml

7,5 ltr.

Glas inkl. Zapfhahn

Getränkespender „NORDIC WOOD“

beverage dispenser
dispensador de bebidas
distributeur de boissons

Behälter mit Edelstahlzapfhahn und Korkdeckel, stabiles Glas, inkl. Holzstandfuß und Kork-Untersetzer

container with stainless steel tap and cork cover, solid glas, incl. wooden base and cork coaster

recipiente con grifo de acero inoxidable y tapa de corcho, cristal sólido, incl. pie de madera y posavasos de corcho

réipient avec robinet en acier inox et couvercle de liège, verre robuste, incl. pied en bois et soucoupes de liège

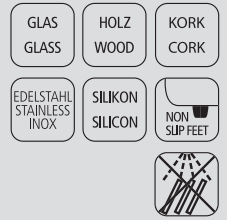

	cm	↑ cm	ltr.	
10435	23 x 23	60,5	7,5	inkl. Gestell / incl. stand

Trinkbecher „CRYSTAL“
drinking cup / vaso / gobelet



	Ø cm	↑ cm	ltr.	VE
10501	8	12,5	0,3	48

Ersatzteile Getränkspender „NORDIC WOOD“

parts beverage dispenser
recambios dispensador de bebidas
pièces distributeur de boissons

Ersatz-Deckel zu Getränkspender
replacement lid for beverage dispenser
tapa de recambio para el dispensador de bebidas
couvercle de rechange pour le distributeur de boissons



	Ø cm	↑ cm
10428	11,5	1,5

Ersatz-Glas zu Getränkspender „NORDIC WOOD“, inkl. Zapfhahn
replacement glass for beverage dispenser with tap
cristal de recambio para el dispensador de bebidas con grifo
vitre de rechange pour le distributeur de boissons avec robinet



	Ø cm	↑ cm	ltr.
10427	17	46	7,5

Ersatz-Untersetzer aus Kork zu Getränkspender „NORDIC WOOD“
replacement cork coaster for beverage dispenser
posavasos de corcho de recambio para el dispensador de bebidas
soucoupes de liège de rechange pour le distributeur de boissons



	Ø cm	↑ cm
10424	16,5	1,5

Ersatz-Gestell zu Getränkspender „NORDIC WOOD“
stand for beverage dispenser
soporte de recambio para el dispensador de bebidas
support de remplacement pour le distributeur de boissons



	cm	↑ cm	Farbe / Colour
10426	23 x 23	14	



Getränkespender
beverage dispenser
dispensador de bebidas
distributeur de boissons



dicke, stabile Wände, weite Öffnung für große Zutaten

thick, stable walls, a wide opening for large ingredients

tiene paredes gruesas y estables, amplia abertura para ingredientes grandes

des murs épais et stables, large ouverture pour de grands ingrédients

	Ø cm	↑ cm	ltr.
10855	20	30,5	7



Tropfenschale (2-tlg.)
drip tray
aros anti-goteo
anneaux coupe-gouttes



	Ø cm	↑ cm	Farbe / Colour
10851	9,5	1,5	
10853	9,5	1,5	



Trinkbecher „CRYSTAL“
drinking cups
vasos
gobelets

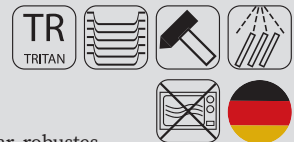

Kristallglas-Optik, vielseitig einsetzbar, robustes, unzerbrechliches Material, ideal in sensiblen Bereichen wie Pool, Spa, Beach und Wellness einzusetzen, BPA-frei

crystal-glass-look, can be used in versatile ways, a solide and unbreakable material, ideal to be used in pool, spa, beach and wellness areas, bpa-free

look de vidrio, se pueden utilizar de muchas maneras diferentes, material sólido e irrompible, ideal para el uso en áreas como piscina, spa, playa y bienestar, libre de BPA

look de verre de cristal, peuvent être utilisés de différentes façons, matériau robuste et incassable, idéal pour une utilisation dans des zones comme la piscine, le spa, la plage et le bien-être, sans BPA

	Ø cm	↑ cm	ltr.	VE
10500	7	9,5	0,15	48
10501	8	12,5	0,30	48
10502	9	15,5	0,50	48



12 ltr.

Kaffeedispenser „ROYAL“

coffee dispenser
dispensador de café
distributeur de café



hochglanzpoliert, für warme Getränke, stabil und standfest, inkl. 1 Brennpastenbehälter
mirror polished finish, for warm drinks, solid and stable, incl. 1 burner holder
acabado brillante para bebidas calientes, sólido y estable, incluye un calentador
brillant, pour boissons chaudes, avec 1 brûleur, robuste et stable

	cm	↑ cm	ltr.
11667	28 x 28	65	12



10,5 ltr.

Kaffeedispenser „HAPPY HOUR“

coffee dispenser
dispensador de café
distributeur de café



hochglanzpoliert, für warme Getränke, stabil und standfest, inkl. 1 Brennpastenbehälter
mirror polished finish, for warm drinks, solid and stable, incl. 1 burner holder
acabado pulido brillante para bebidas calientes, sólido y estable, incluye un calentador
brillant, pour boissons chaudes, avec 1 brûleur, robuste et stable

	cm	↑ cm	ltr.
11672	31 x 33,5	54,5	10,5

Hahn / tap / grifo / robinet

11671

Elektro-Heizelement / heating unit / resistencia / résistance

	cm	↑ cm
12287	21 x 20	6



Saftdispenser „TOP FRESH“

juice dispenser
dispensador de zumo
distributeur à jus de fruit



hochglanzpoliert, Kühlung durch 2 Kühlakkus von oben und unten
mirror polished finish, cooling with 2 cooling elements from the top and base

base inox brillante, con 2 acum. de frio, 1 arriba y 1 en la base

base inox poli brillant, 2 plaques de froid (1 dans le couvercle, 1 dans le socle)

	cm	↑ cm	ltr.
10800	21 x 32	43	4
10700	23 x 35	52	6



Saftdispenser DUO „TOP FRESH“

juice dispenser
dispensador de zumo
distributeur à jus de fruit



hochglanzpoliert, Kühlung durch 2 Kühlakkus von oben und unten

mirror polished finish, cooling with 2 cooling elements from the top and base

base inox brillante, con 2 acum. de frio, 1 arriba y 1 en la base

base inox poli brillant, 2 plaques de froid (1 dans le couvercle, 1 dans le socle)

	cm	↑ cm	ltr.
10720	42 x 32	52	2 x 6



Saft- und Milchdispenser MIX „TOP FRESH“

juice and milk dispenser
dispensador mixto zumo y leche
distributeur mixte à lait et à jus de fruit



6 Liter Saftbehälter, 5 Liter Milchkanne, Kühlung durch Kühlakkus von oben und unten

6 liters juice container, 5 liters milkcan, cooling with cooling elements from the top and base

recipiente de zumo 6 litros, recipiente de leche 5 litros, 2 enfriadores récipient à jus 6 l, récipient à lait 5 l, plaques de froid

	cm	↑ cm	ltr.
10760	42 x 35	52	6 + 5



Saftdispenser WOOD „TOP FRESH“

juice dispenser
dispensador de zumo
distributeur à jus de fruit



Buchen-Holz versiegelt, Kühlung durch 2 Kühlakkus von oben und unten (nur 10730)

beech wood, waterproof, cooling with 2 cooling elements from the top and base (only 10730)

madera de haya con tratamiento anti humedad, 2 acumuladores de frío, 1 en la base y 1 en la tapa (solamente 10730)

bois de hêtre traité anti-humidité, 2 plaques de froid, 1 dans le couvercle, 1 dans le socle (seulement 10730)

	cm	↑ cm	ltr.
10820	21 x 31	44	4
10730	23 x 35	52	6



1) Deckel / cover / tapa / couvercle	
für ltr. / for ltr. / para ltr. / pour ltr.	
10701	6
10801	4
2) Kühlakku / cooler / acumulador de frío / accumulateur de froid	
für ltr. / for ltr. / para ltr. / pour ltr.	
10777	4 / 6
3) Behälter inkl. Zapfhahn / container incl. tap recipiente con grifo / récipient avec robinet	
für ltr. / for ltr. / para ltr. / pour ltr.	
10703	6
10803	4
3) Behälter ohne Zapfhahn / container without tap recipiente sin grifo / récipient sans robinet	
für ltr. / for ltr. / para ltr. / pour ltr.	
10704	6
10804	4
4) Non-Drip Hahn / non-drip tap / grifo anti-goteo / robinet anti-goutte	
für ltr. / for ltr. / para ltr. / pour ltr.	
10707	6
10807	4
5) Dichtungsring / sealing ring / arandela / rondelle	
für ltr. / for ltr. / para ltr. / pour ltr.	
10608	4 / 6
6) Einsatz / insert / aro inox / cercle inox	
für ltr. / for ltr. / para ltr. / pour ltr.	
10708	6
10808	4
7) Standfuß 18/10 Edelstahl / column 18/10 stainless steel base inox 18/10 / socle inox 18/10	
für ltr. / for ltr. / para ltr. / pour ltr.	
10709	6
10809	4
8) Tropfgitter 18/10 Edelstahl / drip lattice 18/10 stainless steel rejilla recoge gotas 18/10 / grille ramasse-gouttes 18/10	
für ltr. / for ltr. / para ltr. / pour ltr.	
10712	6
10713	DUO
10812	4
9) Bodenplatte 18/10 Edelstahl / footing 18/10 stainless steel base de 18/10 acero / socle inox 18/10	
für ltr. / for ltr. / para ltr. / pour ltr.	
10710	6
10711	DUO / 6 + 6
10814	4
Zubehör / Reinigungsset - für die regelmäßige Reinigung	
1x Dichtung, 2x Dichtungsring (transparent), 1x Dichtungsring (s / w) 1x seal, 2x sealing ring (transparent), 1x sealing ring (b / w)	
für Zapfhahn 10707	
10714	
für Zapfhahn 10807	
10715	
für Zapfhahn 10907	
10716	
für Zapfhahn 10867	
10717	



Saftdispenser WOOD DUO „TOP FRESH“

juice dispenser
dispensador de zumo
distributeur à jus de fruit

HOLZ
WOOD

EDELSTAHL
STAINLESS
INOX
18/8



SAN
KUNSTSTOFF

**Buchen-Holz versiegelt,
Kühlung durch 2 Kühllakkus von oben und unten**

beech wood, waterproof, cooling with 2 cooling elements
from the top and base

madera de haya con tratamiento anti humedad, 2 acumuladores
de frio (1 en la base y 1 en la tapa)

bois de hêtre traité anti-humidité, 2 plaques de froid (1 dans le
couvercle, 1 dans le socle)

	cm	↑ cm	ltr.
10740	42 x 35	52	2 x 6



Saft- und Milchdispenser WOOD DUO „TOP FRESH“

juice and milk dispenser
dispensador de zumo
distributeur à jus de fruit

HOLZ
WOOD

EDELSTAHL
STAINLESS
INOX
18/8



SAN
KUNSTSTOFF

**6 Liter Saftbehälter, 5 Liter Milchkanne, Kühlung durch
Kühllakkus von oben und unten, Buchen-Holz versiegelt**

6 liters juice container, 5 liters milkcan, cooling with cooling
elements from the top and base, beech wood, waterproof

madera de haya con tratamiento anti humedad, acumuladores
de frio, enfriador en la base

bois de hêtre traité anti-humidité, plaques dans le socle

	cm	↑ cm	ltr.
10765	42 x 35	52	6 + 5



hot
price

9,5 ltr.

einklappbare FüÙe
foldable feet

Iso-Dispenser

insulated dispenser
dispensador isotérmico
distributeur de boisson isothermique

ABS
KUNSTSTOFF

EDELSTAHL
STAINLESS
INOX
18/8

für heiÙe und kalte Getrânke

for hot and cold drinks

para bebidas frías y calientes

pour boissons chaudes ou froides

	Ø cm	↑ cm	ltr.
10788	24	42	9,5

Hahn / tap / grifo / robinet

10789



7 ltr.

Getrânkespender

beverage dispenser
dispensador de bebidas
distributeur de boissons

GLAS
GLASS

EDELSTAHL
STAINLESS
INOX



dicke, stabile Wände, weite Öffnung für große Zutaten

thick, stable walls, a wide opening for large ingredients

tiene paredes gruesas y estables, amplia abertura para
ingredientes grandes

des murs épais et stables, large ouverture pour de grands ingrédients

	Ø cm	↑ cm	ltr.
10855	20	30,5	7

Buffet & Display



Saftdispenser „SUNDAY“

juice dispenser
dispensador de zumo
distributeur à jus de fruit



matt poliert, Kühlung durch 2 Kühlakkus von oben und unten

satin polished finish, cooling with 2 cooling elements from the top and base

acabado pulido brillante, 2 acum. de frío (1 en la base y 1 en la tapa)

inox mat, 2 accus. de froid (1 socle et 1 couvercle)

	cm	↑ cm	ltr.
10860	21 x 35	48	6



Saft- / Milchdispenser „SUNDAY“

juice and milk dispenser
dispensador mixto zumo y leche
distributeur mixte à lait et à jus de fruit



matt poliert, Behälter gefrostet, Kühlung durch 2 Kühlakkus von oben und unten

satin polished finish, canister frosted look, cooling with 2 cooling elements from the top and base

inox acabado pulido mate, 1 recipiente policarbonato aspecto glaseado, 2 enfriadores en la base y en la tapa

inox mat, récipient polycarbonate opaque, 2 accus. de froid dans le socle et dans le couvercle

	cm	↑ cm	ltr.
10865	21 x 35	48	6



Saftdispenser DUO „SUNDAY“

juice dispenser
dispensador de zumo doble
distributeur à jus de fruit double



matt poliert, Kühlung durch 4 Kühlakkus von oben und unten

satin polished finish, cooling with 4 cooling elements from the top and base

inox acabado pulido mate, 4 enfriadores en la base y en la tapa

inox mat, 4 accus. de froid (socle et couvercle)

	cm	↑ cm	ltr.
10862	35 x 45	48	2 x 6



Saft- / Milchdispenser DUO „SUNDAY“

juice and milk dispenser
dispensador mixto zumo y leche
distributeur mixte à lait et à jus de fruit



matt poliert, 1 Behälter gefrostet, 1 Behälter transparent, 4 Kühlakkus von oben und unten

satin polished finish, 1 canister frosted look, 1 canister transparent, cooling with 4 cooling elements from the top and base

inox mate, 1 recipiente opaco, 1 recipiente transparente, 4 enfriadores (base y tapa)

inox mat, 1 récipient opaque, 1 récipient transparent, 4 accus. de froid (socle et couvercle)

	cm	↑ cm	ltr.
10864	35 x 45	48	2 x 6

Saftbehälter transparent, ohne Zapfhahn / juice canister transparent, without tap / contenedor transparente sin grifo / récipient cylindrique sans le robinet

	Ø cm	↑ cm	ltr.
10806	22	26	6

Milchbehälter, gefrostet, ohne Zapfhahn / milk canister, frosted look, without tap / contenedor de leche, efecto glaseado, sin grifo / récipient cylindrique mat (idéal pour le lait) sans le robinet

	Ø cm	↑ cm	ltr.
10805	22	26	6

Hahn / tap / grifo / robinet

10867



Milchkanne „TOP FRESH“

milk dispenser
dispensador de leche
distributeur à lait



hochglanzpoliert, 1 Kühlakku im Standfuß, „original Milchkanne mit Henkel“
mirror polished finish, 1 cooler in base, original milkcan
inox brillante, 1 acumulador de frío en la base, recipiente „lechera“
inox poli brillant, 1 accum. de froid dans le socle, design „pot à lait“

	cm	↑ cm	ltr.
10830	21 x 32	39	3
10750	23 x 35	45	5

Milchkanne ohne Zapfhahn / milkcan without tapjarra de leche sin grifo / récipient à lait sans robinet

	Ø cm	↑ cm	ltr.
10833	16	22	3
10663	22	26	5



4 ltr. / 6 ltr.

Saftdispenser „BRIDGE“

juice dispenser
dispensador de zumo
distributeur à jus



Kühlung durch 2 Kühlakkus von oben und unten
cooling with 2 cooling elements from the top and base
2 acum. de frío 1 en la base y 1 en la tapa
2 plaques de froid 1 dans le couvercle, 1 dans le socle

	cm	↑ cm	ltr.	Farbe / Colour
10870	31,0 x 20	42	4	Orange
10871	35,5 x 22	50	6	Orange



inkl. 3 Magnetschilder: ORANGE, APPLE, GRAPEFRUIT
including 3 magnetic signs: ORANGE, APPLE, GRAPEFRUIT



4 ltr. / 6 ltr.

Saftdispenser „BRIDGE“

juice dispenser
dispensador de zumo
distributeur à jus



Kühlung durch 2 Kühlakkus von oben und unten
cooling with 2 cooling elements from the top and base
2 acum. de frío 1 en la base y 1 en la tapa
2 plaques de froid 1 dans le couvercle, 1 dans le socle

	cm	↑ cm	ltr.	Farbe / Colour
10872	31,0 x 20	42	4	Black
10873	35,5 x 22	50	6	Black



inkl. 3 Magnetschilder: ORANGE, APPLE, GRAPEFRUIT
including 3 magnetic signs: ORANGE, APPLE, GRAPEFRUIT

Buffet & Display



Milchkanne „TOP FRESH“

milk dispenser
dispensador de leche
distributeur à lait



inkl. Porzellanschild zum Beschriften, 1 Kühllakku im Fuß
incl. porcelain sign, 1 cooler in base
incluye cartelito en porcelana, 1 enfriador en la base
indicateur en porcelaine inclus, plaque de froid dans le socle

	cm	↑ cm	ltr.
10850	31 x 21	42	4



Milchkanne „TOP FRESH“

milk dispenser
dispensador de leche
distributeur à lait



Buchen-Holz versiegelt, inkl. Porzellanschild zum Beschriften, 1 Kühllakku im Fuß
beech wood, waterproof, incl. porcelain sign, 1 cooler in base
madera de haya, resistente al agua, incluye placa de porcelana, 1 enfriador en la base
socle bois hêtre traité, indicateur en porcelaine inclus, plaque de froid dans le socle

	cm	↑ cm	ltr.
10840	23 x 32,0	42	4
10757	27 x 38,5	45	8

Milchkanne Porzellan, ohne Zapfhahn / milkcan porcelain, without tap / jarra de leche sin grifo / récipient en porcelaine sans robinet

	Ø cm	↑ cm	ltr.
10825	18	25	4
10758	22	26	8

Deckel für 10840, 10850 / cover for 10840, 10850 / tapa para 10840, 10850 / couvercle pour 10840, 10850

10859

Deckel für 10757 / cover for 10757 / tapa para 10757 / couvercle pour 10757

10759

Schild und Kette / shield and chain / placa y cadena / indicateur porcelaine avec chaînette

10756

Zapfhahn / tap / grifo / robinet

10907



Milchkanne WOOD „TOP FRESH“

milk dispenser
dispensador de leche
distributeur à lait



Buchen-Holz versiegelt, 1 Kühllakku im Standfuß, „original Milchkanne mit Henkel“
beech wood, 1 cooler in base, original milkcan
madera de haya, 1 acumulador de frio en base
bois de hêtre, 1 plaque de froid dans le socle

	cm	↑ cm	ltr.
10835	21 x 32	39	3
10755	23 x 35	47	5



Saftdispenser „INOX STAR“

juice dispenser
dispensador de zumo
distributeur à jus de fruit



Edelstahl-Crasheisröhre herausnehmbar

stainless steel crash ice tube
con tubo inox refrigerante extraíble para hielo picado
avec tube inox réfrigérant amovible pour glace pilée

	cm	↑ cm	ltr.
10795	36 x 26	55	8



Saftdispenser DUO „INOX STAR“

juice dispenser
dispensador de zumo
distributeur à jus de fruit



Edelstahl-Crasheisröhre herausnehmbar

stainless steel crash ice tube
con tubo inox refrigerante extraíble para hielo picado
avec tubes inox réfrigérants amovibles pour glace pilée

	cm	↑ cm	ltr.
10810	36 x 52	55	2 x 8

Behälter / container / recipiente / récipient

	Ø cm	ltr.
10796	22	8

Deckel 18/10 Edelstahl hochglanzpoliert / cover 18/10 stainless steel mirror polished finish / tapa 18/10 inox pulido brillante / couvercle inox 18/10 poli brillant

10797

Crasheisröhre / crash ice tube / tubo para hielo picado / tube pour glace pilée

10798

Non-Drip Hahn / non-drip-tap / grifo anti-goteo / robinet anti-goutte

10799

Dichtungsring / sealing ring / arandela / rondelle

10793

Silikondichtung / sealing / junta / joint

10794

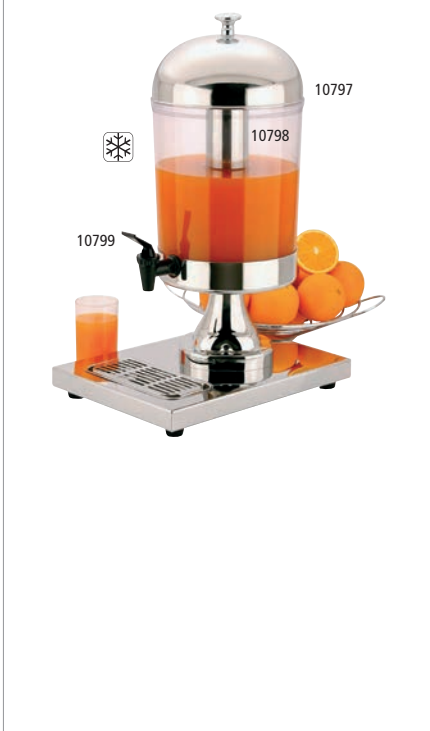

Buffet & Display



Pump-Isolierkanne „BUDGET“

air pot
jarra termo
bouteille isotherme



doppelwandig, Tragegriff, Dreh-Pumpknopf zur leichten Bedienung (close/open), Pumpmechanismus ist leicht zu entnehmen und zu reinigen, aufgeklappt passt die Kanne unter die gängigen Kaffeeautomaten, für heiße und kalte Getränke

double-walled, carrying handle, rotatable Push-Button for easy use (close/open), pump mechanism is easily removable for cleaning, with flipped-back lid, the air pot fits under a wide range of coffee makers, for hot and cold beverages

doble pared, con asa al lateral, tapa girable y a presión para uso fácil (close/open), el mecanismo a presión es fácil de retirar para limpiar, con la tapa abierta la jarra se puede usar con casi todas las cafeteras corrientes, para bebidas frías y calientes

double paroi, avec poignée, couvercle à visser et a pression pour facile usage (close/open), le mécanisme a pression est facile à retirer pour le nettoyage, avec la couvercle ouverte la bouteille se peut user avec toutes les machines à café courantes, pour boissons chaudes ou froides

	Ø cm	↑ cm	ltr.	Anzahl der Tassen
10915	13,5	32,5	2,2	17



Pump-Isolierkanne „PREMIUM“

air pot
jarra termo
bouteille isotherme



doppelwandig, Tragegriff, drehbarer Fuß, Pumpmechanismus und Füllstandsanzeige sind leicht zu reinigen mit 4 unterschiedlichen Inhaltsbeschriftungen für den Pumphebel (coffee, tea, hot water, decaf), aufgeklappt passt die Kanne unter die gängigen Kaffeeautomaten, für heiße und kalte Getränke

double-walled, carrying handle, pivotable feet, pump mechanism and fill level indicator is easily removable for cleaning, includes 4 different beverage signs (coffee, tea, hot water, decaf), with flipped-back lid, the air pot fits under a wide range of coffee makers, for hot and cold beverages

doble pared, con asa al lateral, pié girable, el mecanismo a presión y el indicador óptico del nivel son fácil de limpiar, con 4 etiquetas diferentes para la palanca (coffee, tea, hot water, decaf), con la tapa abierta la jarra se puede usar con casi todas las cafeteras corrientes, para bebidas frías y calientes

double paroi, avec poignée, pied pivotant, le mécanisme a pression et l'indicateur de niveau sont facile à retirer pour le nettoyage, avec 4 étiquettes différents pour la pompe (coffee, tea, hot water, decaf), avec la couvercle ouverte la bouteille se peut user avec toutes les machines à café courantes, pour boissons chaudes ou froides

	Ø cm	↑ cm	ltr.	Anzahl der Tassen
10916	15	37	3	24

Tropfenfänger für Pump-Isolierkanne / drip tray for air pot / recoge gotas para jarra termo / ramasse-gouttes pour bouteilles isotherme

	cm	↑ cm
10917	24 x 18,5	4



Isolierkanne „ECONOMY“

vacuum jug
jarra termo
bouteille isotherme



robuste Umhüllung mit Polypropylen-Kunststoff, Stabilglaseinsatz, Drehverschluss mit Drucktasten-Bedienung für heiße und kalte Getränke, 8 Tassen

double-walled with glass liner, screw cap with easy push-button pouring system, for hot and cold beverages, 8 cups

exterior de plástico polipropileno, interior aislante de vidrio, con tapa a rosca con cierre dosificador para bebidas frías y calientes, 8 tazas

extérieur en plastique polypropylène, intérieur avec plaque de verre, couvercle à visser, pour boissons chaudes ou froides, 8 tasses

	Ø cm	↑ cm	ltr.	Farbe / Colour
10913	16	20	1	White
10914	16	20	1	Black



Isolierkanne „CLASSIC“

vacuum jug
jarra termo
bouteille isotherme



doppelwandig, Einhandautomatik, Drehverschluss, für heiße und kalte Getränke
double-walled, easy push-button pouring system, screw cap, for hot and cold drinks
doble pared, se maneja con 1 mano, con tapa a rosca, para bebidas frías y calientes
double paroi, usage à 1 main, couvercle à visser, pour boissons chaudes ou froides

	Ø cm	↑ cm	ltr.	Anzahl der Tassen
10910	14	19	1,0	8
10911	14	22	1,5	12
10912	14	25	2,0	16



Isolierkanne „ADVANCED“

vacuum jug
jarra termo
bouteille isotherme

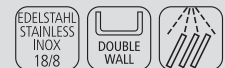

doppelwandig, spülmaschinenfest, Einhandautomatik, aufgeklappt passt die Kanne unter die gängigen Kaffeeautomaten, für heiße und kalte Getränke
double-walled, dishwasher-safe, easy pouring system, with flipped-back lid, the air pot fits under a wide range of coffee makers, for hot and cold beverages
doble pared, resistente al lavavajillas, se maneja con 1 mano, con la tapa abierta la jarra se puede usar con casi todas las cafeteras corrientes, para bebidas frías y calientes
double paroi, résistante au lave-vaisselle, usage à 1 main, avec la couvercle ouverte a bouteille se peut user avec toutes les machines à café courantes, pour boissons chaudes ou froides

	Ø cm	↑ cm	ltr.	Anzahl der Tassen
10921	10,5	13,0	0,3	2,5
10922	10,5	18,0	0,6	5,0
10923	13,0	19,5	1,0	8,0
10924	13,0	23,5	1,5	12,0

NEW ACACIA

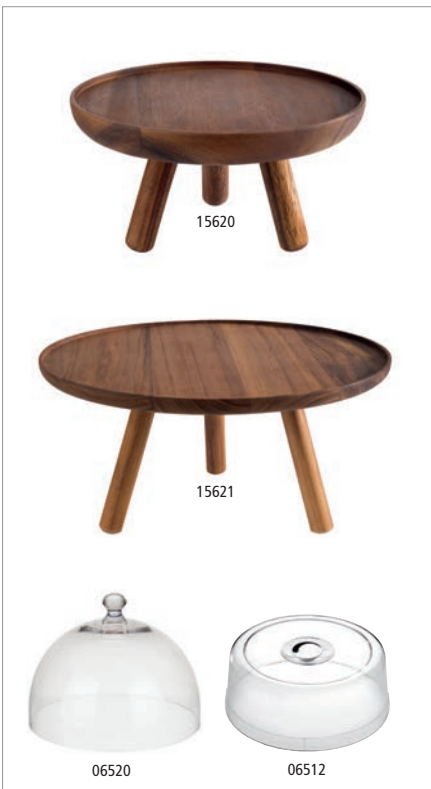

Buffetständer „ACACIA“

buffet stand
soporte para buffet
présentoir buffet



Akazienholz geölt / acacia wood oiled / mader de acacia aceitada / bois d'acacia huilé

	Ø cm	↑ cm
15620	20,0	10,5
15621	30,5	15,0
15622	30,5	20,0

Frischhalte- Haube / cover / campana / cloche



	Ø cm	↑ cm	fits to
06520	30	22	15621, 15622

Frischhalte- Haube / cover / campana / cloche



	Ø cm	↑ cm	fits to
06512	30	11,5	15621, 15622



Buffetständer „ACACIA“

buffet stand
soporte para buffet
présentoir buffet



Akazienholz geölt / acacia wood oiled / mader de acacia aceitada / bois d'acacia huilé

	cm	↑ cm	GN
15623	53 x 16,2	20	2/4

GN Abdeckhaube / GN cover / GN cubierta/ GN cloche



	cm	↑ cm	✱ mm	GN
11044	53 x 16,2	10,5	3	2/4

Buffetständer



Buffetständer „STAR“

buffet stand
soporte para buffet
présentoire buffet



Metall, mit schwarzer Antirutschbeschichtung
metal, with black anti-slide coating
metal, con revestimiento antideslizante negro
métal, avec revêtement antidérapant noir

	↑ cm
33260	8
33261	12
33262	18



Buffetständer „MULTI ROUND“

buffet stand
soporte para buffet
présentoir buffet



Metall, mit schwarzer Antirutschbeschichtung
metal, with black anti-slide coating
metal, con revestimiento antideslizante negro
métal, avec revêtement antidérapant noir

	Ø cm	↑ cm
33269	15,5 / 18	8
33270	15,5 / 18	10
33271	15,5 / 18	18

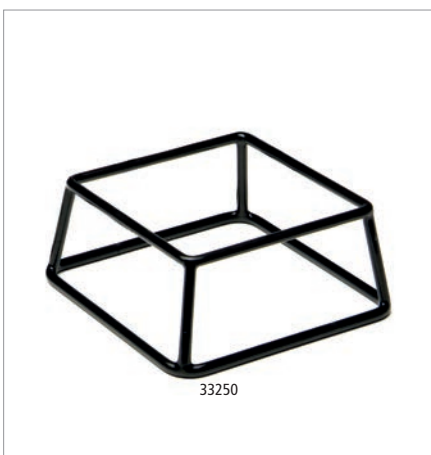

Buffetständer „MULTI“

buffet stand
soporte para buffet
présentoir buffet



Metall, mit schwarzer Antirutschbeschichtung
metal, with black anti-slide coating
metal, con revestimiento antideslizante negro
métal, avec revêtement antidérapant noir

	cm	↑ cm
33249	18 x 18	5
33250	18 x 18	8
33251	18 x 18	10
33252	18 x 18	18

Buffet & Display

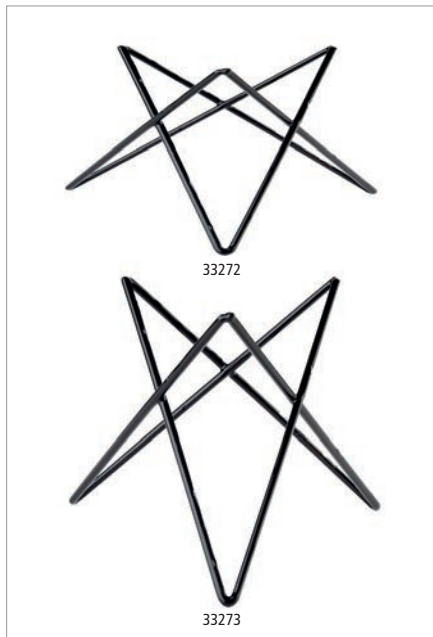

Buffetständer „PRISMA“

buffet stand
soporte para buffet
présentoir buffet



Metall, mit schwarzer Antirutschbeschichtung

metal, with black anti-slide coating
metal, con revestimiento antideslizante negro
métal, avec revêtement antidérapant noir

	Ø cm	↑ cm
33272	20	10,5
33273	20	20,0



Buffetständer „WOOD“

buffet stand
soporte para buffet
présentoir buffet



Akazienholz, liegend oder stehend, variable Nutzungsmöglichkeiten

acacia wood, usable by lying or standing, there are many possibilities to use
madera de acacia, se puede usar tumbado o de pie, hay diferentes opciones de utilizar
bois d'accacia, il y a différentes possibilités d'usage

	cm	↑ cm	Farbe / Colour
33280	20 x 20	17,5	
33281	20 x 20	17,5	



liegend oder stehend, variable Nutzungsmöglichkeiten
vertically or horizontally, there are variable usage possibilities



Buffetständer

buffet stand
expositor de buffet
présentoir buffet



Akazienholz

acacia wood
madera de acacia
bois d'accacia

	Ø cm	↑ cm
33255	15	10
33256	25	15

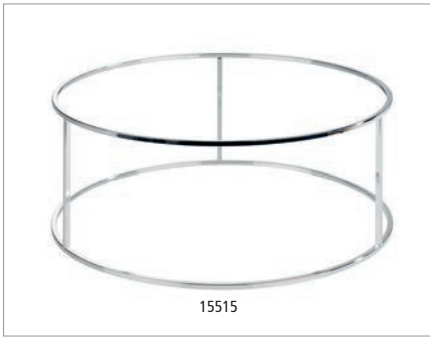

Buffetständer „ASIA PLUS“

buffet stand
soporte para buffet
présentoir buffet



	Ø cm	↑ cm	Farbe / Colour
15515	38,0	16,5	■
15516	38,0	27,0	■
15517	48,5	16,5	■
15518	48,5	27,0	■

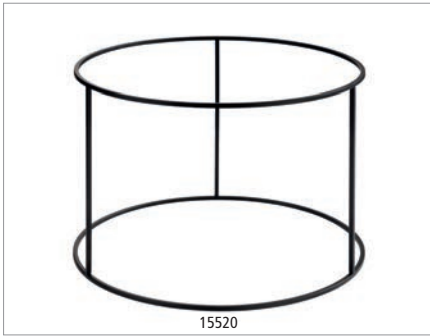

Buffetständer „ASIA PLUS“

buffet stand
soporte para buffet
présentoir buffet



	Ø cm	↑ cm	Farbe / Colour
15519	38,0	16,5	■
15520	38,0	27,0	■
15521	48,5	16,5	■
15522	48,5	27,0	■

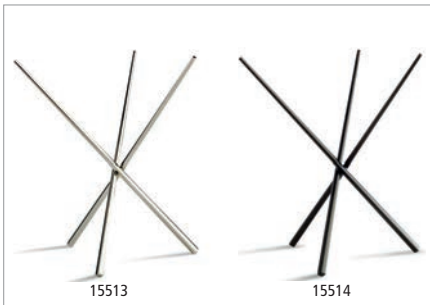

Buffetständer „ASIA PLUS“

buffet stand
soporte para buffet
présentoir buffet



	Ø cm	↑ cm	Farbe / Colour
15513	20,5 / 16,5	20	■
15514	20,5 / 16,5	20	■



Buffetständer „KING“

buffet stand
soporte para buffet
présentoir buffet



kein Verrutschen, Arme und Boden sind mit Antirutschflächen ausgestattet, schwere standsichere Qualität, Fuß dient als Löffelablage

the arms and base are equipped with non-slip surfaces, stable quality, base serves as spoon holder
anti-deslizante: revestimiento antideslizante en las puntas de los brazos y en la base, estable y alta calidad, la base sirve como reposacuchara

antiglisse: revêtement antidérapant sur les extrémités des 3 pieds et sur la base, robuste, stable et bonne qualité, la base sert de support pour les couverts

	Ø cm	↑ cm
03622	15	14
03623	15	21



Buffet-Tower

buffet tower
torre para buffet
tour carrée pour le buffet



3-stufig, Glas in Spiegeloptik, Holz Birke dunkelbraun, Lieferung demontiert
with beech wood pillar, tempered glass mirror surface, each in knock-down packing

3 pisos, vidrio templado, eje central de madera oscura, se entrega desmontado

3 étages, verre trempé, axe central carré en bois foncé, livré non-monté

	cm	↑ cm
12415	25 x 25	30,5



High Tea Rack

High Tea Rack
rack de te alto
étagère à thé avec anse supérieure



Holz dunkelbraun, Edelstahlgriff, 4 große Fächer 15 x 10 x 10 cm, 3 kleine Fächer 9,5 x 9,5 x 10 cm

rubber wood in dark brown, stainless handle, 4 big compartments 15 x 10 x 10 cm, 3 small compartments 9,5 x 9,5 x 10 cm

madera marrón oscura, mango de acero inoxidable, 4 compartimentos grandes 15 x 10 x 10 cm, 3 compartimentos pequeños 9,5 x 9,5 x 10 cm

bois marron foncé, poignée inox, 4 compartiment grand 15 x 10 x 10 cm, 3 compartiment petit 9,5 x 9,5 x 10 cm

	cm	↑ cm
33210	34 x 10	38

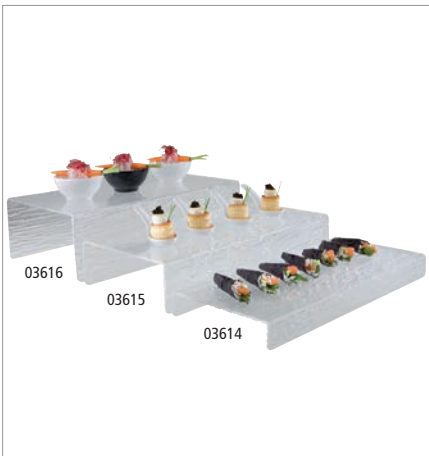

Stufen-Display

tier display
expositor en escalera
présentoir en escalier



mit Schieferstruktur

with slate structure
con relieve tipo pizarra
avec relief irrégulier type ardoise

	cm	↑ cm
03614	40 x 18	4
03615	40 x 20	8
03616	40 x 22	12



Stufen-Display, 3-tlg.

tier display, 3 pcs.
expositor en escalera, set de 3
présentoir en escalier, set de 3



3-teiliges Set: 03614 + 03615 + 03616

3 pcs. set: 03614 + 03615 + 03616

set de 3: 03614 + 03615 + 03616

set de 3: 03614 + 03615 + 03616

	cm	↑ cm
03617	40 x 18 / 40 x 20 / 40 x 22	4 / 8 / 12



Stufen-Display, 3-tlg.

tier display, 3 pcs.
expositor en escalera, set de 3
présentoir en escalier, set de 3



3-teiliges Set: 03618 + 03619 + 03620

3 pcs. set: 03618 + 03619 + 03620

set de 3: 03618 + 03619 + 03620

set de 3: 03618 + 03619 + 03620

	cm	↑ cm
03621	20 x 18 / 20 x 20 / 20 x 22	4 / 8 / 12

NEW



passende Akazienholzplatte
fitting acacia wood panels

33206



33207

Ø 25 cm, H: 1 cm



33207

Ø 25 cm, H: 1 cm



Gestell mit abgerundeten Füßen
frame with rounded feet

Buffetgestell „BIRDCAGE“

buffet stand
soporte para buffet
présentoir buffet

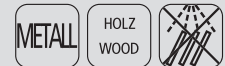

Gestell aus Metall schwarz, inkl. 2 Akazienholzplatten
black metal frame, incl. 2 acacia wood panels
soporte metálico negro, incl. 2 tableros de madera de acacia
support métallique noir, avec 2 panneaux en bois d'acacia

	Ø cm	↑ cm	
33206	26	54	2-stufig / 2-tier / 2 alturas / 2 niveaux

Ersatz-Holzplatte / spare wooden panel / tablero de madera de recambio / panneau en bois de rechange rechange

	Ø cm	↑ cm	
33207	25	1	



Ø 12,0 cm

Ø 20,5 cm

Ø 25,0 cm

Ø 30,5 cm

Buffetgestell „LIGHT HOUSE“

buffet stand
soporte para buffet
présentoir buffet



Gestell aus Metall schwarz, inkl. 4 Glasplatten
frame made of metal, incl. 4 glass plates
soporte metálico, incl. 4 placas de vidrio
support métallique, avec 4 plaques de verre

	Ø cm	↑ cm	
11660	33	62	4-stufig / 4-tier / 4 alturas / 4 niveaux

Ersatz-Glasplatten / spare glass / fuente de recambio vidrio / plat de rechange en verre

	Ø cm		
11653	12 / 20,5 / 25,0 / 30,5	bestehend aus 4 Glasplatten	4er Set / 4 pcs. set / set de 4 / set de 4

Buffet & Display

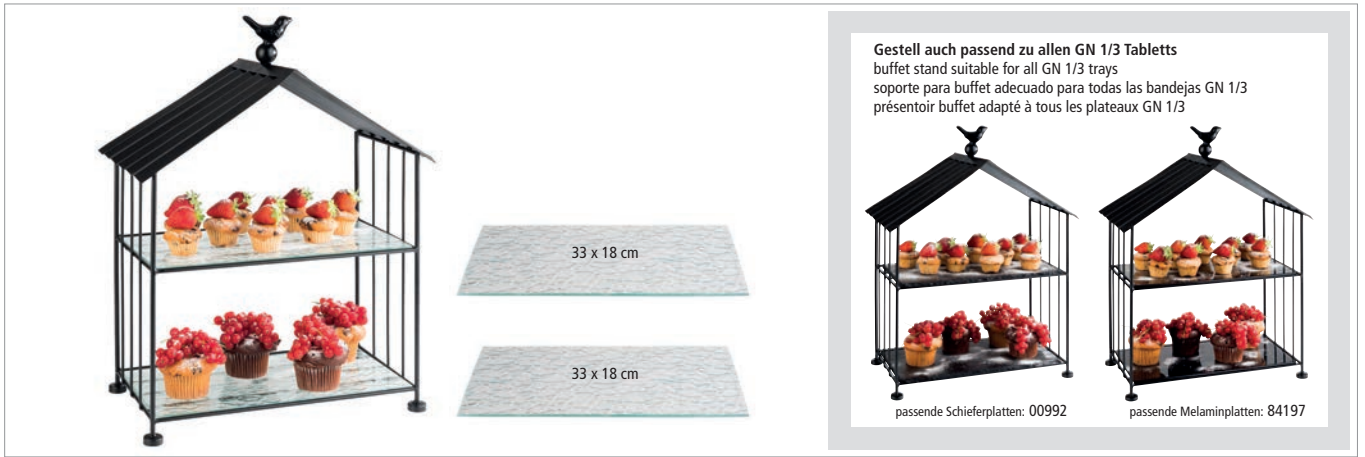

Buffetgestell „BIRD“

buffet stand
soporte para buffet
présentoir buffet

Gestell aus Metall schwarz, inkl. 2 Glasplatten je 33 x 18 cm
frame made of metal, incl. 2 glass plates, each 33 x 18 cm
soporte metálico, incl. 2 placas de vidrio, cada una 33 x 18 cm
support métallique, avec 2 plaques de verre, chacun 33 x 18 cm



	cm	↑ cm	fits to GN	
11661	37,5 x 21	50	1/3-trays	2-stufig / 2-tier / 2 alturas / 2 niveaux

Ersatz-Glasplatten / spare glass / fuente de recambio vidrio / plat de rechange en verre

	cm			
11654	33 x 18		bestehend aus 2 Glasplatten	2er Set / 2 pcs. set / set de 2 / set de 2



Buffetgestell „TRIANGLE“

buffet stand
expositor de buffet
présentoir buffet



	cm	↑ cm	
13966	53 x 21	50	Ahorn / maple



Buffetgestell „TRIANGLE“

buffet stand
expositor de buffet
présentoir buffet



	cm	↑ cm	
14966	53 x 21	50	Wenge / wenge

NEW Buffetbrücke



Präsentationsmöglichkeit / presentation opportunity



Buffetbrücke
buffet bridge
puente de buffet
pont de buffet



Buffetbrücke aus Akazienholz
buffet bridge from acacia wood
puente de buffet de madera de acacia
pont de buffet en bois d'acacia

	cm	↑ cm
33285	45 x 17	22
33286	70 x 17	22



Lieferung erfolgt demontiert
delivery disassembled
se entrega desmontada
livraison démontée



Buffettisch MINI „VINTAGE“
buffet stand
soporte para buffet
présentoir buffet



	cm	↑ cm	fits to
11634	40 x 21,5	15	GN 1/3 trays



Buffetgestell
buffet stand
soporte para buffet
présentoir buffet



3-stufig, geeignet für runde und rechteckige Körbe, platzsparend zusammenklappbar
3-tier, usable for round and rectangular baskets, can be pushed together for place saving
3 alturas, apto para cestas redondas y rectangulares, se puede plegar para ahorrar espacio
3 hauteurs, pour corbeilles rondes ou rectang, la structure s'ouvre ou se ferme pour réduire l'encombrement

	cm	↑ cm
33232	59 x 30,5	59

Tisch- und Buffetkorb, rund „ECONOMIC“ / buffet basket, round / cesta de bufé redonda / corbeille de buffet ronde

	Ø cm	↑ cm	Farbe / Colour
40144	39	10	

Lieferung ohne Körbe
delivery without baskets

BUFFETDISPLAY



Buffetgestell, 3-tlg.

buffet stand, 3 pcs.
expositor de buffet, set de 3
présentoir buffet, set de 3



3-teilig:

1. Fach 40 x 23 cm x H 33 cm;
2. Fach 40 x 20,5 cm x H 20 cm;
3. Fach 40 x 18 cm x H 9 cm

3 pcs. set: 40 x 23 cm x H 33 cm; 40 x 20,5 cm x H 20 cm; 40 x 18 cm x H 9 cm
set de 3: 40 x 23 cm x H 33 cm; 40 x 20,5 cm x H 20 cm; 40 x 18 cm x H 9 cm
set de 3: 40 x 23 cm x H 33 cm; 40 x 20,5 cm x H 20 cm; 40 x 18 cm x H 9 cm

	cm	↑ cm	Farbe / Colour	
11606	40 x 23	33		Wenge

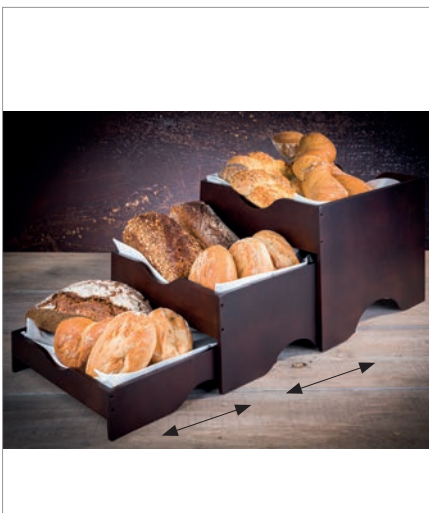

Buffetgestell, 3-tlg.

buffet stand, 3 pcs.
expositor de buffet, set de 3
présentoir buffet, set de 3



3-teilig:

1. Fach 40 x 40 cm x H 33 cm;
2. Fach 40 x 37 cm x H 20 cm;
3. Fach 40 x 34 cm x H 9 cm

3 pcs. set: 40 x 40 cm x H 33 cm; 40 x 37 cm x H 20 cm; 40 x 34 cm x H 9 cm
set de 3: 40 x 40 cm x H 33 cm; 40 x 37 cm x H 20 cm; 40 x 34 cm x H 9 cm
set de 3: 40 x 40 cm x H 33 cm; 40 x 37 cm x H 20 cm; 40 x 34 cm x H 9 cm

	cm	↑ cm	Farbe / Colour	
11607	40 x 40	33		Wenge



Etagère „ROYAL“

etagère
expositor
présentoir



5-teilig: 3 Edelstahl-Schalen + 2 Gestelle, einfach übereinanderstellen, einzeln nutzbar

5 pcs. set: 3 bowls + 2 frames, easy to assemble, single usable

set de 5: 3 bols + 2 soportes, fácil de montar

set de 5: 3 bols + 2 supports, montage facile

	Ø cm	↑ cm
24336	24 / 33 / 42	43,5

Schale / bowl / fuente / plateau

	Ø cm	↑ cm	litr.
24330	24	3	0,6
24331	33	4	1,3
24332	42	5	2,5

Gestell einzeln / stand alone / pie soporte / pied seul

	Ø cm	↑ cm
24338	18	19
24339	24	20



Etagère „ROYAL“

etagère
estante
présentoir



3-teilig: 2 Edelstahl-Schalen + 1 Gestell, einfach übereinanderstellen, einzeln nutzbar

3 pcs. set: 2 bowls + 1 frame, easy to assemble, single usable

set de 3: 2 bols + 1 soporte, fácil de montar

set de 3: 2 bols + 1 support, montage facile

	Ø cm	↑ cm
24335	33 / 42	25
24334	24 / 33	22

Schale / bowl / fuente / plateau

	Ø cm	↑ cm	litr.
24330	24	3	0,6
24331	33	4	1,3
24332	42	5	2,5

Gestell einzeln / stand alone / pie soporte / pied seul

	Ø cm	↑ cm
24338	18	19
24339	24	20



Etagère

etagère
frutero
corbeille à fruits



ergonomischer Griff, stehend auf schwarzen Antirutsch-Füßen

ergonomic handle, anti-slip-feets

asa ergonómica, pies antideslizantes color negro

anse ergonomique, pieds antidérapants noirs

	cm	↑ cm
30325	30 x 30	35,5

NEW ROMANTIC

*Eyecatcher-
Guarantee*



33204



33201



33203

Serviergestell „ROMANTIC“

serving stand
soporte platos
présentoir à assiettes

EDELSTAHL
STAINLESS
INOX

für 3 Teller max. Ø 17,5 cm, innerer Ring Ø 10 cm, Lieferung ohne Teller
for 3 plates max. Ø 17,5 cm, circle inside Ø 10 cm, delivery without dishes
para 3 platos máx. Ø 17,5 cm, aro interior Ø 10 cm, se entrega sin platos
pour 3 assiettes Ø 17,5 cm maxi., anneau intérieur Ø 10 cm, livré sans assiettes

	cm	↑ cm	Farbe / Colour	
33200	22,5 x 16	32		weiß / white
33202	22,5 x 16	32		schwarz / black
33204	22,5 x 16	32		antik-kupfer / antique-copper

für 3 Teller max. Ø 27 cm, innerer Ring Ø 16 cm, Lieferung ohne Teller
for 3 plates max. Ø 27 cm, circle inside Ø 16 cm, delivery without dishes
para 3 platos máx. Ø 27 cm, aro interior Ø 16 cm, se entrega sin platos
pour 3 assiettes Ø 27 cm maxi., anneau intérieur Ø 16 cm, livré sans assiettes

	Ø cm	↑ cm	Farbe / Colour	
33201	30	54		weiß / white
33203	30	54		schwarz / black
33205	30	54		antik-kupfer / antique-copper



Serviergestell

serving stand
soporte platos
présentoir à assiettes



für 4 Teller (max. Ø 31 cm), platzsparend zusammendrehbar, Lieferung ohne Teller
for 4 plates (max. Ø 31 cm), can be pushed together for place saving, without dishes
para 4 platos (max. Ø 31 cm) se puede plegar para ahorrar espacio, se sirve sin platos
pour 4 assiettes (maxi Ø 31 cm), peut se refermer pour réduire l'encombrement, livré sans assiettes

	Ø cm	↑ cm
33225	34	37



Serviergestell

serving stand
soporte platos
présentoir à assiettes



für 2 Teller max. Ø 27 cm, innerer Ring Ø 18 cm, Lieferung ohne Teller
for 2 plates max. Ø 27 cm, circle inside Ø 18 cm, without dishes
para 2 platos Ø 27 cm, interior aro Ø 18 cm, se entrega sin platos
pour 2 assiettes maxi Ø 27 cm, cercle Ø int. 18 cm, livré sans assiettes

	cm	↑ cm
33214	33 x 23,5	30



Serviergestell

serving stand
soporte platos
présentoir à assiettes



für 3 Teller max. Ø 17 cm, innerer Ring Ø 10,5 cm
for 3 plates max. Ø 17 cm, circle inside Ø 10,5 cm
para 3 platos Ø 17 cm, interior aro Ø 10,5 cm
pour 3 assiettes maxi Ø 17 cm, cercle Ø int. 10,5 cm

	cm	↑ cm
33216	22,5 x 16,5	25,5



Serviergestell

serving stand
soporte platos
présentoir à assiettes



für 3 Teller max. Ø 27 cm, innerer Ring Ø 18 cm
for 3 plates max. Ø 27 cm, circle inside Ø 18 cm
para 3 platos Ø 27 cm, interior aro Ø 18 cm
pour 3 assiettes maxi Ø 27 cm, cercle Ø int. 18 cm

	cm	↑ cm
33217	33 x 24	43

Buffet & Display

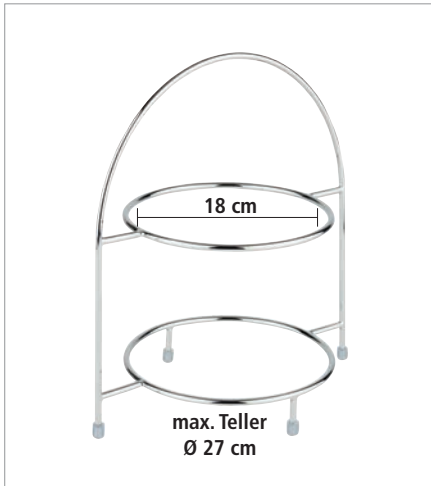

Serviergestell

serving stand
soporte platos
présentoir à assiettes



für 2 Teller max. Ø 27 cm, innerer Ring Ø 18 cm
for 2 plates max. Ø 27 cm, circle inside Ø 18 cm
para 2 platos Ø 27 cm, interior aro Ø 18 cm
pour 2 assiettes maxi Ø 27 cm, cercle Ø int. 18 cm

	cm	↑ cm	Farbe / Colour
33219	29 x 19,5	30	



Serviergestell

serving stand
soporte platos
présentoir à assiettes



für 3 Teller max. Ø 17 cm, innerer Ring Ø 10,5 cm
for 3 plates max. Ø 17 cm, circle inside Ø 10,5 cm
para 3 platos Ø 17 cm, interior aro Ø 10,5 cm
pour 3 assiettes maxi Ø 17 cm, cercle Ø int. 10,5 cm

	cm	↑ cm	Farbe / Colour
33215	18,5 x 15,5	26	chrome
33211	18,5 x 15,5	26	copper



Serviergestell

serving stand
soporte platos
présentoir à assiettes



für 3 Teller max. Ø 27 cm, innerer Ring Ø 18 cm
for 3 plates max. Ø 27 cm, circle inside Ø 18 cm
para 3 platos Ø 27 cm, interior aro Ø 18 cm
pour 3 assiettes maxi Ø 27 cm, cercle Ø int. 18 cm

	cm	↑ cm	Farbe / Colour
33220	29 x 19,5	43	chrome
33212	29 x 19,5	43	copper



Etagère

etagère
frutero
présentoir à fruits



hochglanzpoliert, Edelstahl-Schale herausnehmbar
mirror polished finish, bowl removable
acabado brillante, bandeja inferior suelta
effet brillant, bol inférieur amovible

	Ø cm	↑ cm
33235	27,5	32
33240	32,0	53



Servier- und Tortenplatte „ACACIA MINI“

cake stand
porta pasteles
présentoir à gâteaux

Akazienholz geölt
acacia wood oiled
madera de acacia aceitada
bois d'acacia huilé



	Ø cm	↑ cm
33290	9,5	7
33291	13,0	9



Servier- und Tortenplatte „ACACIA“

cake stand
porta pasteles
présentoir à gâteaux

Akazienholz geölt
acacia wood oiled
madera de acacia aceitada
bois d'acacia huilé



	Ø cm	↑ cm
33292	24,0	8
33293	24,0	16
33294	33,0	8
33295	33,0	16
33296	38,5	8
33297	38,5	16



Frischhalte- Haube / cover / campana / cloche



	Ø cm	↑ cm	fits to
06519	21	17	33292, 33293
06520	30	22	33294, 33295
06521	36	27	33296, 33297

Buffet & Display



Serviergestell

serving stand
expositor
présentoir



3-stufig für quadratische Teller / Platten in 3 verschiedenen Größen:
z.B. 83407 + 83406 + 83405, Lieferung ohne Teller/Platten

3-tier for square dishes / plates in 3 different sizes: e.g. 83407 + 83406 + 83405,
delivery without dishes / plates

3 alturas para platos cuadrados fuentes en 3 diferentes medidas p.e. 83407 + 83406 + 83405,
se entrega sin platos/ fuentes

3 niveaux pour assiettes ou plats carrés de différentes dimensions, ex. 83407 + 83406 + 83405,
livré sans assiettes

	cm	↑ cm
33231	37,5 x 37,5	50



Etagère „CASUAL“

etagère
expositor de bombones o bocaditos
présentoir à mignardises



inklusive Edelstahl-Schild, beschriftbar

including sign

placa incluida, sin inscripción

étiquette incluse, sans inscription

	Ø cm	↑ cm	
34248	31 - 41 - 51	55	3-stufig / 3-tier 3 niveles / 3 étages
34247	31 - 41	35	2-stufig / 2-tier 2 niveles / 2 étages



Etagère „FINESSE“

etagère
frutero
étagère



vergoldeter Messing-Kugelgriff, einfache Montage

gold plated knob, easy to assemble

botón dorado, fácil de montar

bouton doré, montage facile

	Ø cm	↑ cm	
33248	48 / 38 / 32	50	3-stufig / 3-tier 3 alturas / 3 niveaux
33238	38 / 32	30	2-stufig / 2-tier 2 alturas / 2 niveaux



3-stufige Etagère

3-tier tray
bandeja con tres alturas
étagère carré 3 hauteurs



Naturschiefer, Akazienholz

natural slate tray, wood akazie

bandeja de pizarra natural, madera de acacia

plateau ardoise naturelle, bois d'acacia

	Ø cm	↑ cm	mm
00960	30 / 25 / 20	34	6 - 9



2-stufige Etagère

2 tier tray
bandeja dos alturas
plat carré 2 hauteurs

Naturschiefer
natural slate tray
bandeja de pizarra natural
plateau ardoise naturelle



	Ø cm	↑ cm	* mm
00989	25 / 20	24	6 - 9



Brezel- oder Wurstständer

pretzel-/ sausage stand
soporte para embutidos
support à bretzel ou à saucissons

Verkaufsständer Buchen-Holz versiegelt, bestens geeignet für die Präsentation von Brezeln, Würstchen, etc., Fuß Ø 22 cm

beech wood, ideal to present pretzels, sausages, etc.
madera de haya, ideal para presentar fiambres, salchichones etc.
en hêtre, idéal pour bretzels ou saucissons, etc.



	Ø cm	↑ cm
79553	28	50

Hygieneschutz für Brezelständer / hygienic cover / cubierta higiénica antialiento / pare-haleine

	cm	↑ cm
11557	20 x 20 x 20	50
11558	15 x 20 x 15	50



Serviergestell, 2-stufig

servicing stand, 2-tier
soporte platos, 2 alturas
présentoir, 2 hauteurs

3 tlg. Set, 1 Gestell aus Akazienholz, 2 Schieferplatten, zusammenklappbar

3 pcs. set, 1 stand acacia wood, 2 slate tray, foldable

set de 3: 1 soporte madera de acacia, 2 bandeja de pizarra, fácil de plegar

set de 3: 1 présentoir au pour tous les seaux à FRAMES



zusammenklappbar
foldable

	cm	↑ cm
00958	36,5	34 x 26,5



Serviergestell „FLEXIBEL“

servicing stand
expositor
présentoir

3-stufig „beweglich / drehbar“, platzsparend zerlegbar

3 tier, flexible frame, space saving

3 alturas, marco flexible, ahorra espacio

3 hauteurs, cadre souple, gagne de la place



	cm	↑ cm
33243	45,5 x 32	21,5

Tablett „PURE COLOR“ / tray / bandeja / plateau

	cm	↑ cm	Farbe / Colour
83403	35,5 x 18	3	_____



Serviergestell „S-PURE“

serving stand
soporte buffet
support buffet



für 3 Tablett quadratisch 83407 oder 83418

for 3 trays square 83407 or 83418

para 3 bandejas cuadradas 83407 o 83418

pour 3 plats carrés 83407 ou 83418

	cm	↑ cm
33226	29 x 17	41



Serviergestell „M-PURE“

serving stand
soporte buffet
support buffet



für 3 Tablett quadratisch 83406 oder 83407

for 3 trays square 83406 or 83407

para 3 bandejas cuadradas 83406 o 83407

pour 3 plats carrés 83406 o 83407

	cm	↑ cm
33227	33 x 21	44



Serviergestell „L-PURE“

serving stand
soporte buffet
support buffet



für 3 Tablett rechteckig 83417

for 3 trays rectangular 83417

para 3 bandejas rectangulares 83417

pour 3 plats rectangulaires 83417

	cm	↑ cm
33228	37 x 21	44



GN Serviergestell „XL-PURE“

GN serving stand
GN soporte buffet
GN support buffet



passend für Tablett GN 1/1, GN 1/2, GN 1/3, GN 2/4

suitable for tray GN 1/1, GN 1/2, GN 1/3, GN 2/4

aptas para bandejas GN 1/1, GN 1/2, GN 1/3, GN 2/4

convient pour les plats GN 1/1, GN 1/2, GN 1/3, GN 2/4

	cm	↑ cm
33222	63 x 27	44,5



Buffetgestell „FLOAT SMALL“

buffet stand
soporte buffet
support buffet



Metall verchromt, für 3 Schalen Nr. 83916, 83917
metal chrome plated, for 3 bowls no. 83916, 83917
metal cromado, para 3 cuencos N° 83916, 83917
métal chromé, pour 3 coupelles 83916, 83917

	cm	↑ cm
33241	55,5 x 19	15,5

Schale „FLOAT“ / bowl / cuenco / bol

	cm	↑ cm	Farbe / Colour
83916	19 x 19	9,5	White
83917	19 x 19	9,5	Black



Buffetgestell „FLOAT BIG“

buffet stand
soporte buffet
support buffet



Metall verchromt, für 3 Schalen Nr. 83914, 83915, für 1 Schale Nr. 83918, 83919
metal chrome plated, for 3 bowls no. 83914, 83915, for 1 bowl no. 83918, 83919
metal cromado, para 3 cuencos N° 83914, 83915, para 1 cuenco N° 83918, 83919
métal chromé, pour 3 coupelles 83914, 83915 ou 1 bol 83918, 83919

	cm	↑ cm
33242	39 x 39	17

Schale „FLOAT“ / bowl / cuenco / bol

	cm	↑ cm	Farbe / Colour
83914	12,5 x 12,5	6,0	White
83918	25,0 x 25,0	12,0	White
83915	12,5 x 12,5	6,0	Black
83919	25,0 x 25,0	12,0	Black

Buffetleiter GN



Buffetleiter „LITTLE GN 1/3“

buffet ladder
dispensador en escalera
présentoir buffet en escalier



4-teilig: 1 Leiter-Gestell, 3 GN 1/3 Rahmen
4 pcs.: 1 ladder, 3 single rings GN 1/3
4 pz: 1 soporte escalera, 3 aros sencillos GN 1/3
4 pc: 1 support escalier, 3 cercles simples GN 1/3

	cm	↑ cm	fits to
11526	31,5 x 32	48	baskets / pans GN 1/3



Buffetleiter „LITTLE GN 1/2“

buffet ladder
dispensador en escalera
présentoir buffet en escalier



4-teilig: 1 Leiter-Gestell, 3 GN 1/2 Rahmen
4 pcs.: 1 ladder, 3 single rings GN 1/2
4 pz: 1 soporte escalera, 3 aros sencillos GN 1/2
4 pc: 1 support escalier, 3 cercles simples GN 1/2

	cm	↑ cm	fits to
11527	31,5 x 41,5	48	baskets / pans GN 1/2

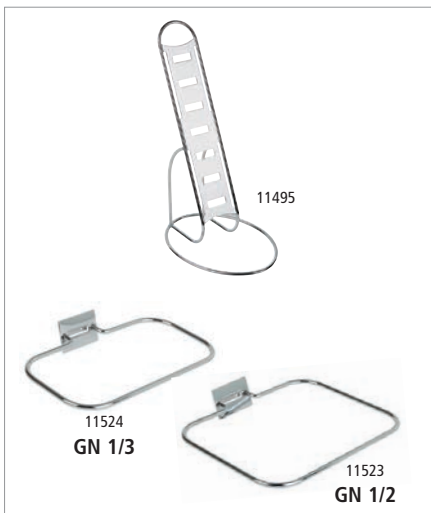

Einzelteile / spare parts / piezas sueltas / pièces détachées

Leitergestell / frame / marco solo en escalera / échelle support

11495

Einzelring GN 1/3 / single ring GN 1/3 / aro sencillo GN 1/3 / cercle simple GN 1/3

11524

Einzelring GN 1/2 / single ring GN 1/2 / aro sencillo GN 1/2 / cercle simple GN 1/2

11523



Buffetleiter „BIG GN 1/2“
buffet ladder
dispensador en escalera
présentoir buffet en escalier



5-teilig: 1 Leiter-Gestell, 4 GN 1/2 Rahmen
5 pcs.: 1 ladder, 4 single rings GN 1/2
5 pz: 1 soporte escalera, 4 aros sencillos GN 1/2
5 pc: 1 support escalier, 4 cercles simples GN 1/2

	cm	↑ cm	fits to
11528	31,5 x 56	66	baskets / pans GN 1/2



Buffetleiter „BIG GN 1/1“
buffet ladder
dispensador en escalera
présentoir buffet en escalier



4-teilig: 1 Leiter-Gestell, 3 GN 1/1 Rahmen
4 pcs.: 1 ladder, 3 single rings GN 1/1
4 pz: 1 soporte escalera, 3 aros sencillos GN 1/1
4 pc: 1 support escalier, 3 cercles simples GN 1/1

	cm	↑ cm	fits to
11529	52 x 59	66	baskets / pans GN 1/1

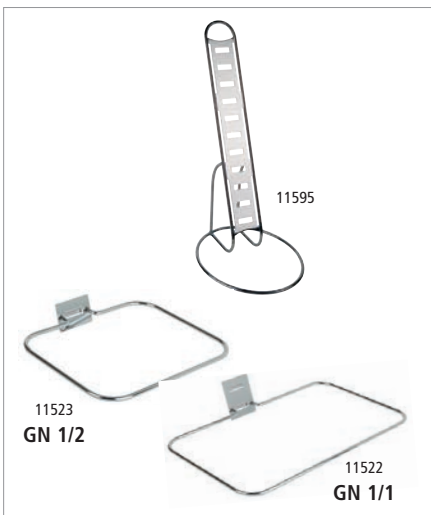

Einzelteile / spare parts / piezas sueltas / pièces détachées

Leitergestell / frame / marco solo en escalera / échelle support

11595

Einzelring GN 1/2 / single ring GN 1/2 / aro sencillo GN 1/2 / cercle simple GN 1/2

11523

Einzelring GN 1/1 / single ring GN 1/1 / aro sencillo GN 1/1 / cercle simple GN 1/1

11522

Buffet & Display



Buffetleiter „BIG“

buffet ladder
dispensador en escalera
présentoir buffet en escalier



12-teiliges Set: 4 Glasschalen Ø 23 cm 2,5 Liter, 4 klappbare Schutzdeckel mit Beschriftungsfenster, 1 Leiter, 1 Doppelring, 2 Einzelringe, einfach und individuell zusammensetzbar

12 pcs. set: 4 glass bowls Ø 23 cm 2.5 litres, 4 hinged covers with card for inscription, 1 ladder, 1 double ring, 2 single rings, easy to fix and individual to use

set de 12: 4 boles vidrio Ø 23 cm 2,5 l, 4 tapas abatibles con ventana para etiqueta, 1 soporte escalera, 1 aro doble, 2 aros sencillos, fácil de montar, posible usar individualmente

set de 12: 4 bols verre Ø 23 cm 2,5 l, 4 couvercles à charnière et fenêtre p/ étiquette, 1 support escalier, 1 cercle double, 2 cercles simples, montage facile, utilisable individuellement

	cm	↑ cm
11598	39 x 31	66



Buffetleiter „BIG“

buffet ladder
dispensador en escalera
Présentoir buffet en escalier



11-teiliges Set: 6 Glasschalen Ø 23 cm 2,5 Liter, 1 Leiter, 2 Doppelringe, 2 Einzelringe, einfach und individuell zusammensetzbar

11 pcs. set: 6 glass bowls Ø 23 cm 2.5 litres, 1 ladder, 2 double rings, 2 single rings, easy and individual to use

set de 11: 6 boles vidrio Ø 23 cm 2,5 l, 1 soporte escalera, 2 aros dobles, 2 aros sencillos, fácil montar, se puede usar individualmente

set de 11: 6 bols verre Ø 23 cm 2,5 l, 1 support escalier, 2 cercles double, 2 cercles simples, montage facile, utilisable individuellement

	cm	↑ cm
11599	39 x 31	66

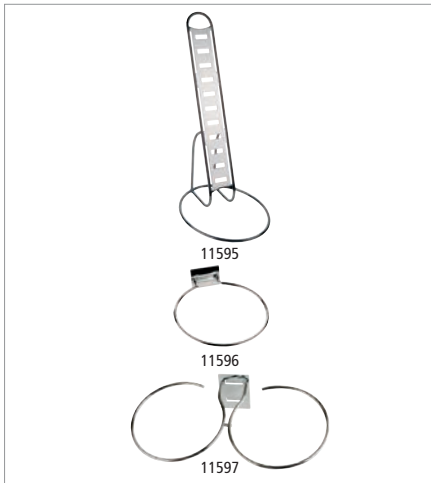

Einzelteile / spare parts / piezas sueltas / pièces détachées

Leitergestell / frame / marco solo en escalera / échelle support

11595

Einzelring / single ring / aro sencillo / cercle simple

11596

Doppelring / double ring / aro doble / cercle double

11597



Schale

bowl
cuenco
bol



	Ø cm	↑ cm	ltr.
11875	23	10,5	2,5



Schutzdeckel mit Löffelaussparung

cover
tapa
couvercle



	Ø cm
11878	23,5



jede Schale /
each bowl
ca. 0,5 ltr.

Buffetleiter „LITTLE“

buffet ladder
dispensador en escalera
présentoir buffet en escalier



12-teiliges Set: 4 Glasschalen Ø 14 cm 0,5 Liter, 4 klappbare Schutzdeckel mit Beschriftungsfenster, 1 Leiter, 1 Doppelring, 2 Einzelringe, einfach und individuell zusammensetzbar

12 pcs. set: 4 glass bowls Ø 14 cm 0.5 litres, 4 hinged covers with card for inscription, 1 ladder, 1 double ring, 2 single rings, easy and individual to use

set de 12: 4 boles vidrio Ø 14 cm 0,5 l, 4 tapas abatibles con ventana para etiqueta, 1 soporte escalera, 1 aro doble, 2 aros sencillos, fácil montaje, se puede usar individualmente

set de 12: 4 bols verre Ø 14 cm 0,5 l, 4 couvercles à charnière et fenêtre p/ étiquette, 1 support escalier, 1 cercle double, 2 cercles simples, montage facile, utilisable individuellement

	cm	↑ cm
11498	30 x 30	48

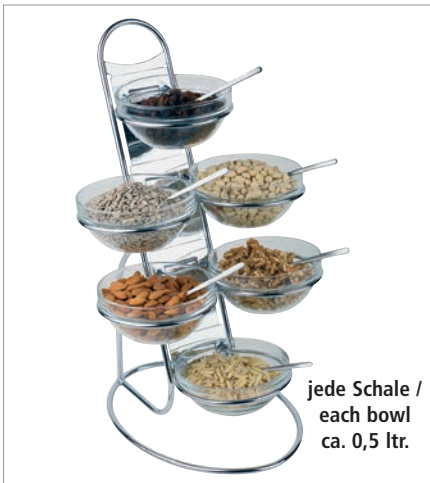

jede Schale /
each bowl
ca. 0,5 ltr.

Buffetleiter „LITTLE“

buffet ladder
dispensador en escalera
Présentoir buffet en escalier



11-teiliges Set: 6 Glasschalen Ø 14 cm 0,5 Liter, 1 Leiter, 2 Doppelringe, 2 Einzelringe, einfach und individuell zusammensetzbar

11 pcs. set: 6 glass bowls Ø 14 cm 0.5 litres, 1 ladder, 2 double rings, 2 single rings, easy and individual to use

set de 11: 6 boles vidrio Ø 14 cm 0,5 l, 1 soporte escalera, 2 aros dobles, 2 aros sencillos, fácil montaje, se puede usar individualmente

set de 11: 6 bols verre Ø 14 cm 0,5 l, 1 support escalier, 1 cercle double, 2 cercles simples, montage facile, utilisable individuellement

	cm	↑ cm
11499	30 x 30	48

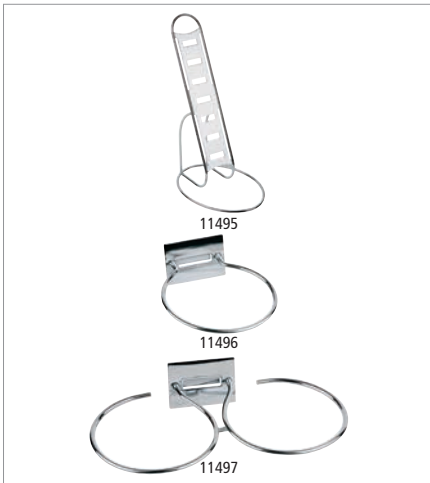

Einzelteile / spare parts / piezas sueltas / pièces détachées

Leitergestell / frame / marco solo en escalera / échelle support

11495

Einzelring / single ring / aro sencillo / cercle simple

11496

Doppelring / double ring / aro sencillo / cercle double

11497



0,5 ltr.

Schale

bowl
cuenco
bol



	Ø cm	↑ cm	ltr.	pcs.
11865	14	6,5	0,5	6



Schutzdeckel mit Löffelaussparung

cover
tapa
couvercle



	Ø cm
11868	14,5

Buffet & Display



Buffetgestell „SUNDAY“

buffet stand
expositor bufé
présentoir buffet



7-teiliges Set: 3 Glasschalen Ø 23 cm (2,5 Liter), 3 klappbare Schutzdeckel, 1 Gestell

7 pcs. set: 3 glass bowls Ø 23 cm (2,5 litres), 3 hinged covers, 1 stand

set de 7: 3 boles vidrio Ø 23 cm (2,5 l), 3 tapas con bisagra, 1 soporte

set de 7: 3 bols verre Ø 23 cm (2,5 l), 3 couvercles à charnière, 1 support

	cm	↑ cm
11795	61 x 24	35



Buffetständer „BIG“

buffet stand
expositor de buffet
présentoir buffet



7-teiliges Set: 3 Glasschalen Ø 23 cm 2,5 Liter, 3 klappbare Schutzdeckel, 1 Ständer

7 pcs. set: 3 glass bowls Ø 23 cm 2.5 litres, 3 hinged covers, 1 stand

set de 7: 3 boles vidrio Ø 23 cm, 2,5 l, 3 tapas con bisagra, 1 soporte

set de 7: 3 bols verre Ø 23 cm 2,5 l, 3 couvercles à charnière, 1 support

	cm	↑ cm
11892	50 x 50	18



Buffetständer „LITTLE“

buffet stand
expositor de buffet
présentoir buffet



7-teiliges Set: 3 Glasschalen Ø 14 cm 0,5 Liter, 3 klappbare Schutzdeckel, 1 Ständer

7 pcs. set: 3 glass bowls Ø 14 cm 0,5 l, 3 hinged covers, 1 stand

set de 7: 3 boles vidrio Ø 14 cm, 0,5 l, 3 tapas con bisagra, 1 soporte

set de 7: 3 bols verre Ø 14 cm 0,5 l, 3 couvercles à charnière, 1 support

	cm	↑ cm
11893	30 x 30	14



Besteckständer „TRIPLE TOWER“

cutlery basket
cesta para cubiertos
égouttoir à couverts



4-teiliges Set: 1 Gestell + 3 Köcher

4 pcs. set: 1 frame + 3 baskets

set de 4: 1 estructura + 3 cubiertos

set de 4: 1 structure + 3 corbeilles

	cm	↑ cm	Farbe / Colour
11466	18 x 26	43	White
11467	18 x 26	43	Black



variable Nutzungsmöglichkeiten
variable usage possibilities



Vitrine / Thekenaufsatz

showcase
vitrina de mostrador
vitrine de comptoir



rutschfest, aus einem Teil gefertigt
antislip, monoblock produced
plástico transparente, fabricado en 1 pieza
transparente, plastique monoblock (injecté)

	cm	↑ cm
11888	63,5 x 25	25



Snackpresenter

snackpresenter
dispensador de bocadillos
présentoir à sandwiches



mit Safrille und Griffmulde, passend für Vitrine 11888
with recessed grip, suitable for showcase 11888
asa moldeada, apto para la vitrina 11888
anse moulée, apte pour vitrine 11888

	cm	↑ cm	
11887	29 x 19	6,5	3 Mulden / 3 compartments 3 compartimentos / 3 compartments
11889	60 x 19	7,5	6 Mulden / 6 compartments 6 compartimentos / 6 compartments

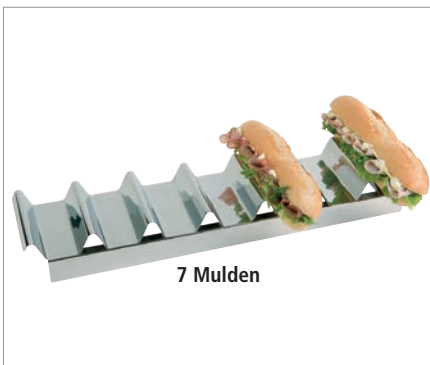

Snackpresenter

snackpresenter
dispensador de bocadillos
présentoir à sandwiches



hochglanzpoliert, mit Griffmulde, für 7 Baguettes
mirror polished finish, with recessed grip, for 7 baguettes
inox pulido brillante, ideal para hasta 7 bocadillos
inox poli brillant, parfait jusque maxi 7 sandwiches

	cm	↑ cm
11891	47,5 x 10,5	6

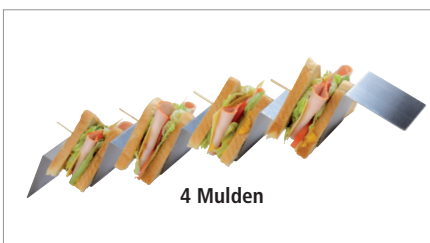

Snackpresenter

snackpresenter
dispensador de bocadillos
présentoir à sandwiches



	cm	↑ cm
11969	56 x 8	5,5

Brotstation

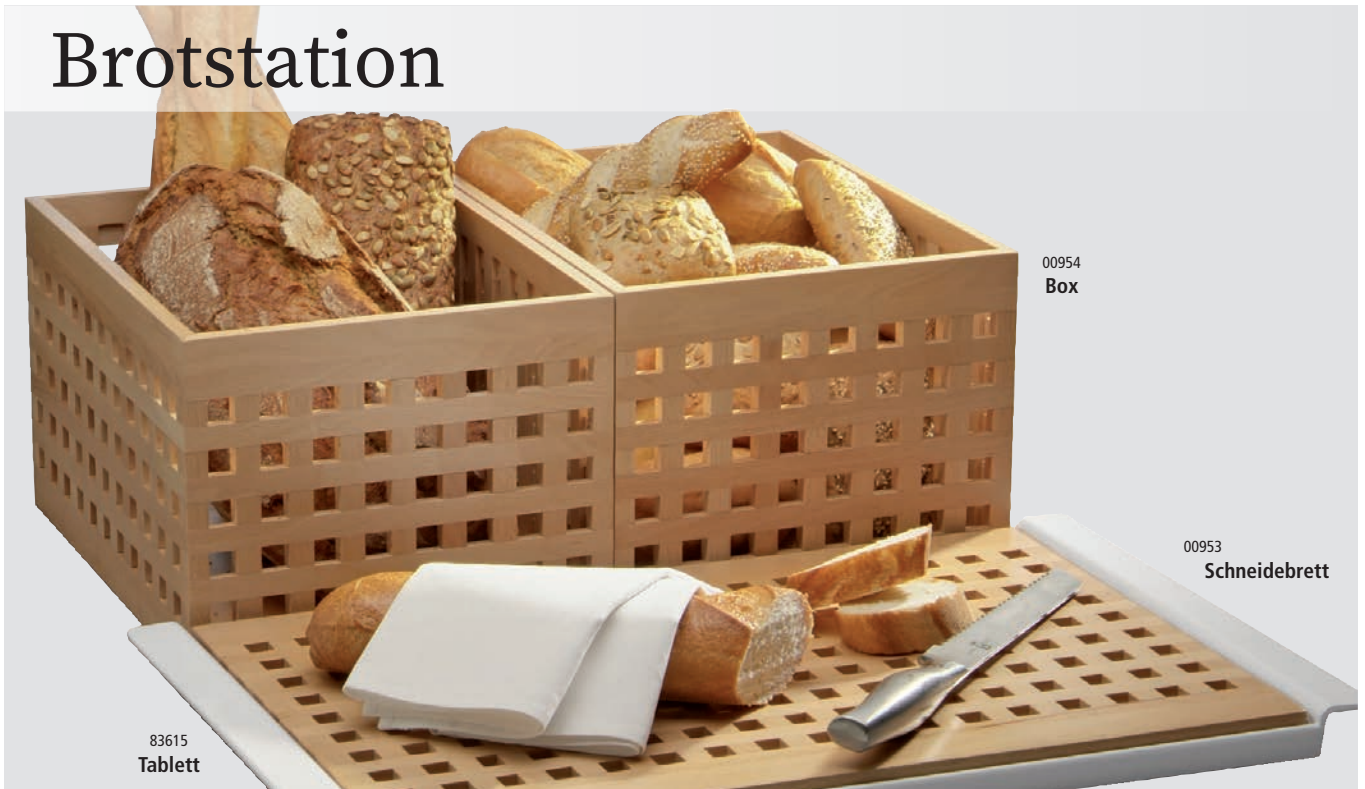

83615
Tablett

00954
Box

00953
Schneidebrett



Tablett „BROTSTATION“

tray
bandeja
plateau



Antirutsch-Füßchen
non-slip feet
pies antideslizantes
pieds antiglisse

	cm	↑ cm
83615	59,5 x 35,5	3,5

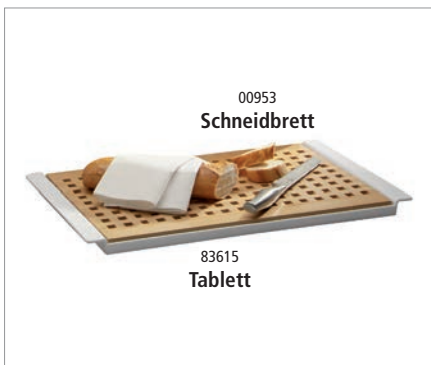

00953
Schneidebrett

83615
Tablett

Brotschneidebrett „BROTSTATION“

cutting board
tabla de corte
planche à découper



Buchen-Holz
beech
haya
hêtre

	cm	↑ cm
00953	52 x 34	2

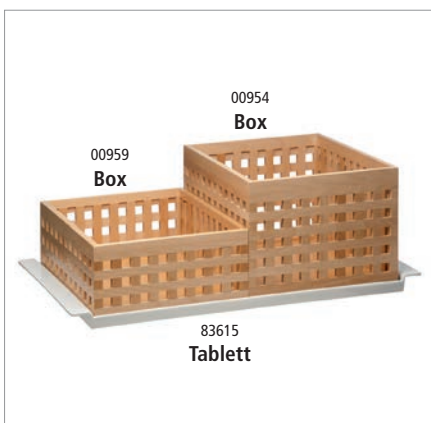

00959
Box

00954
Box

83615
Tablett

Box „BROTSTATION“

box
caja de pan para el buffet
boîte à pain pour le buffet



Buchen-Holz
beech
haya
hêtre

	cm	↑ cm
00959	34 x 26	12,5
00954	34 x 26	20,0



NEW

Buffetbrett „PROFI“
board
tabla para el buffet
planche découper buffet



	cm	↑ cm	
00806	58 x 37,5	4	



Brotschneidebrett „LETTER“
cutting board
tabla para cortar
planche à découper



	cm	↑ cm	
00886	48 x 34	3,5	



Brotschneidebrett „AKAZIA“
cutting board
tabla para cortar
planche à découper



	cm	↑ cm	GN
00883	47,5 x 32,0	2	
00884	53,0 x 32,5	2	1/1
00885	60,0 x 40,0	2	



praktisches Krümfach
practical crump shelf



Brotschneidebrett „RUBBERWOOD“
cutting board
tabla para cortar
planche à découper



	cm	↑ cm	GN
00955	47,5 x 32,0	2	
00956	53,0 x 32,5	2	1/1
00957	60,0 x 40,0	2	



Brotschneidebrett, 2-tlg.
cutting board, 2 pcs.
tabla para cortar, set de 2
planche à découper, set de 2



2-tlg. Set, GN 1/1 Behälter, 20 mm tief, dient als Krümfach
2 pcs. set, GN 1/1 pan 20 mm, bread crump shelf
set de 2: tabla de corte + bandeja inox GN 1/1 alt 20 mm (sirve para recoger las migas)
set de 2: planche à découper bois + plateau inox GN 1/1 Ht 20 mm (sert de ramassemies)

	cm	GN
00951	53 x 32,5	1/1

einzelnes Brett / separate board / tabla por separado / planche seule

	cm	GN
00952	53 x 32,5	1/1



12050
4,5 ltr.

12051
4,5 ltr.

Cerealienspender

cereal dispenser
dispensador de cereales
distributeur de céréales



Behälter herausnehmbar, portionieren durch einfaches Drehen
removable canister, easy to use, rotate the button to get the muesli
contenedor movable, fácil de usar, se gira el pomo para servir los cereales
réceptif amovible, usage facile en tournant le bouton

	cm	↑ cm	ltr.	Farbe / Colour
12050	24 x 17,5	49,5	4,5	White
12051	24 x 17,5	49,5	4,5	Black



12054
2 x 4,5 ltr.

12055
2 x 4,5 ltr.

Cerealienspender „DUO“

cereal dispenser
dispensador de cereales
distributeur de céréales



Behälter herausnehmbar, portionieren durch einfaches Drehen
removable canister, easy to use, rotate the button to get the muesli
contenedor movable, fácil de usar, se gira el pomo para servir los cereales
réceptif amovible, usage facile en tournant le bouton

	cm	↑ cm	ltr.	Farbe / Colour
12054	24 x 37,5	49,5	2 x 4,5	White
12055	24 x 37,5	49,5	2 x 4,5	Black





Buffetständer „GOOD MORNING“

buffet stand
expositor de buffet
présentoir de buffet



4-teiliges Set: Holzständer inkl. 3 Gläser mit luftdichtem Klappdeckel

4 pcs. set: wood stand included 3 glass with airtight cover

set de 4: soporte, 3 boles de cristal, cierre hermético

set de 4: présentoir, 3 bols en verre, fermeture hermétique

	cm	Farbe / Colour
13965	43 x 17	
14965	43 x 17	

Glas mit luftdichtem Klappdeckel / glass with airtight cover / cristal, cierre hermético / verre, fermeture hermétique

	cm	↑ cm	ltr.
82328	12 x 12	22	2



Cerealienspender „FRESH & EASY“

cereal dispenser
dispensador de cereales
distributeur de céréales



Behälter herausnehmbar, „Feierabend-Deckel“ für das aromadichte Lagern, portionieren durch einfaches Drehen

removable canister, special lid to keep the cereals fresh, easy to use, rotate the button to get the muesli

contenedor movable, tapa especial para mantener los cereales frescos, fácil de usar, se gira el pomo para servir los cereales

réceptif amovible, couvercle spécial pour conserver les céréales, usage facile en tournant le bouton

	cm	↑ cm	ltr.
11805	22 x 17,5	52	4,5



Cerealienspender Duo „FRESH & EASY“

cereal dispenser
dispensador de cereales
distributeur de céréales



Behälter herausnehmbar, „Feierabend-Deckel“ für das aromadichte Lagern, portionieren durch einfaches Drehen

removable canister, special lid to keep the cereals fresh, easy to use, rotate the button to get the muesli

contenedor movable, tapa especial para mantener los cereales frescos, fácil de usar, se gira el pomo para servir los cereales

réceptif amovible, couvercle spécial pour conserver les céréales, usage facile en tournant le bouton

	cm	↑ cm	ltr.
11807	22 x 35	52	2 x 4,5

Kunststoffbehälter / canister / contenedor / réceptif

	Ø cm	ltr.
11808	24	4,5



Cerealienspender „CLASSIC“

cereal dispenser
dispensador de cereales
distributeur de céréales



Portionieren durch einfaches Drehen, Behälter herausnehmbar

canister removable

contenedor movable

réceptif amovible

	cm	↑ cm	ltr.
11833	35 x 26,5	68	8



2 x 8 ltr.

Cerealispender „CLASSIC DUO“

cereal dispenser
dispensador de cereales
distributeur de céréales



Portionieren durch einfaches Drehen, Behälter herausnehmbar

canister removable
contenedor movable
récipient amovible

	cm	↑ cm	ltr.
11834	35 x 50	68	2 x 8



13987

14987

Cerealispender „BRIDGE“

cereal dispenser
dispensador de cereales
distributeur de céréales



Behälter herausnehmbar, „Feierabend-Deckel“ für das aromadichte Lagern, portionieren durch einfaches Drehen

removable canister, special lid to keep the cereals fresh, easy to use, rotate the button to get the muesli

contenedor movable, tapa especial para mantener los cereales frescos, fácil de usar, se gira el pomo para servir los cereales

récipient amovible, couvercle spécial pour conserver les céréales, usage facile en tournant le bouton

	cm	↑ cm	ltr.	Farbe / Colour
13987	21 x 20	55,5	4,5	Ahorn
14987	21 x 20	55,5	4,5	Wenge



Cerealispender „ROTATION“

cereal dispenser
dispensador de cereales
distributeur de céréales



matt poliert, drehbarer massiver Ständer, Behälter herausnehmbar, inkl. Frischhaltedeckel

satín polished finish, rotating food, canister removable, incl. airtight covers

pulido acabado satinado, giratorio, incluye tapas herméticas

mat satiné, rotatif, inclut couvercles hermétiques

	Ø cm	↑ cm	ltr.
11970	38	54	3 x 4,5

Kunststoffbehälter / canister / contenedor / récipient

11808



Cerealispender „ROTATION“

cereal dispenser
dispensador de cereales
distributeur de céréales



Buchen-Holz versiegelt, drehbarer massiver Ständer, Behälter herausnehmbar, inkl. Frischhaltedeckel

wood beech covered waterproof, rotating foot, canister removable, incl. airtight cover

tapa en madera de haya resistente al agua, pie giratorio, recipiente removable, incluye tapa hermética

couvercle en hêtre traitée contre l'humidité, pied rotatif, récipients démontables, inclut couvercles hermétiques

	Ø cm	↑ cm	ltr.
11975	38	54	3 x 4,5

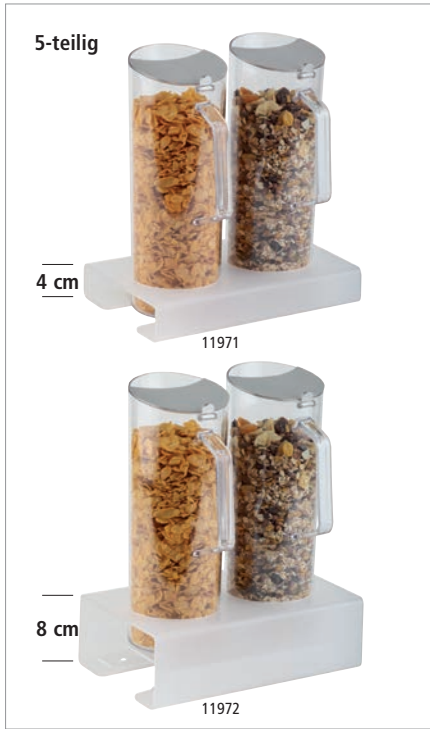

Cerealien-Bar

cereal-bar
barra para dispensador de cereales
bar à céréales



5-teiliges Set, mit Ständerhöhe 4 oder 8 cm: 1 Ständer aus Acryl gefrostet und rutschfest + 2 Karaffen mit schwenkbarem Edelstahl-Deckel + 2 luftdichte Frischhaltedeckel

5 pcs. set, with stand heights 4 or 8 cm: 1 stand acryl frosted and anti-slip + 2 pitchers with stainless steel flap lid + 2 airtight covers

set de 5: stands a diferentes alturas, 4 u 8 cm: 1 stand acryl + 2 jarras con tapa de solapa de acero inoxidable + 2 tapas herméticas adicionales

set de 5: supports à différentes hauteurs: 4 ou 8 cm - 1 support acrylique satiné antiglisse + 2 pichets à céréales avec couvercle à charnière inox + 2 couvercles hermétiques

	cm	↑ cm	ltr.
11971	26 x 17	28,5	2 x 1,5
11972	26 x 17	32,5	2 x 1,5



ideal für Stufenpräsentation
best for staged presentations



Cerealien-Bar

cereal-bar
barra para dispensador de cereales
bar à céréales



7-teiliges Set, mit Ständerhöhe 4 oder 8 cm: 1 Ständer aus Acryl gefrostet und rutschfest + 3 Karaffen mit schwenkbarem Edelstahl-Deckel + 3 luftdichte Frischhaltedeckel

7 pcs. set, with stand heights 4 or 8 cm: 1 stand acryl frosted and anti-slip + 3 pitchers with stainless steel flap lid + 3 airtight covers

set de 7: con stands a diferentes alturas, 4 u 8 cm: 1 stand acryl + 3 jarras con tapa de solapa de acero inoxidable + 3 tapas herméticas adicionales

set de 7: supports à différentes hauteurs: 4 ou 8 cm - 1 support acrylique satiné antiglisse + 3 pichets à céréales avec couvercle à charnière inox + 3 couvercles hermétiques

	cm	↑ cm	ltr.
11973	38 x 17	28,5	3 x 1,5
11974	38 x 17	32,5	3 x 1,5



ideal für Stufenpräsentation
best for staged presentations



Cerealienkaraffe

cereal pitcher
jarra de cereales
pichet à céréales



schwenkbarer Edelstahl-Deckel, inkl. luftdichtem Frischhaltedeckel

stainless steel flap lid, incl. 1 airtight cover

tapa de solapa de acero inoxidable, incluye otra tapa hermética

couvercle à charnière inox + couvercle hermétique

	Ø cm	↑ cm	ltr.
10778	10	28	1,5

Frishhaltedeckel / conservation lid / tapa de conservación / couvercle

10668

SERVICE TOWER



Service Tower

service tower
service tower
tour de service



Präsentations- und Spendersystem, bei minimalen Platzbedarf, optimale Wertschöpfung, zum Beispiel im Bereich der Besteckausgabe, Kaffeestationen, Speiseausgaben, Verkaufstheken, etc., Rückwand aus dunklem Holz oder Acryl gefrostet

Presentation and dispenser system, the products find their best creation of value at minimal need of space, for example in the range of coffeestations, food service, counters etc., backplane made of dark wood or acrylic frosted

sistema de presentación y dispensador, con el mínimo espacio conseguirá una excelente presentación de sus productos, por ejemplo en la zona del café, comidas, etc., trasera de madera oscura o de acrílico opaco mate

système de présentation et distribution, très élégant dans un espace minimum, idéal pour la zone café, coin repas, etc., paroi en bois foncé ou en acrylique mat

	cm	↑ cm	Farbe / Colour	
11431	26 x 18	43	■	2x Schütte, tief + 1x Schütte, flach 2 deep ones + 1 flat one 2 rampas hondas + 1 plana / 2 rampas profundes + 1 plates
11432	26 x 18	43	■	3x Schütte, tief / 3 bowls, deep ones 3 rampas hondas / 3 rampas profundes
11422	26 x 18	57,5	■	4x Schütte, tief / 4 bowls, deep ones 4 rampas hondas / 4 rampas profundes

	cm	↑ cm	Farbe / Colour	
11433	26 x 18	43	■	2x Schütte, tief + 1x Schütte, flach / 2 deep ones + 1 flat one / 2 rampas hondas + 1 plana / 2 rampas profundes + 1 plate
11434	26 x 18	43	■	3x Schütte, tief / 3 bowls, deep ones 3 rampas hondas / 3 rampas profundes
11424	26 x 18	57,5	■	4x Schütte, tief / 4 bowls, deep ones 4 rampas hondas / 4 rampas profundes



Basisfuss / base / pie de la base / pied de la base

11435

Rückwand Holz / backplane made of wood / trasera de madera / arrière bois

	cm	
11436	44,5 x 24	für 3 Schütten
11426	60,0 x 24	für 4 Schütten

Rückwand Acryl / backplane made of acrylic / trasera acrílica / arrière acrylique

	cm	
11437	44,5 x 24	für 3 Schütten
11427	60,0 x 24	für 4 Schütten

Schütte, tief / bowl, deep / rampa, honda / rampe profonde

	cm	↑ cm
11438	22 x 14	7 / 5

Schütte, flach / bowl / rampa plana / rampe plate

	cm	↑ cm
11439	22 x 13	3 / 1

MULTI RACK



Multi Rack

multi rack
dispensador en escalera
support multiple



2-stufig, 3-teilig: 1 Gestell matt poliert + 2 Schütten aus transparent gefrostetem Kunststoff, je ca. 1 Liter

2-tier, 3 pcs. set: 1 frame satin polished finish + 2 bowls frosted plastic, approx. 1 liter
2 alturas - set de 3: 1 soporte inox mate satinado + 2 bols plástico glaseado, aprox. 1 litro
2 niveaux - set de 3: 1 support satiné + 2 bols plastique mat, approx. 1 litre

	cm	↑ cm
11442	19 x 24	28



Multi Rack

multi rack
dispensador en escalera
support multiple



3-stufig, 4-teilig: 1 Gestell matt poliert + 3 Schütten aus transparent gefrostetem Kunststoff, je ca. 1 Liter

3-tier, 4 pcs. set: 1 frame satin polished finish, + 3 bowls frosted plastic, approx. 1 liter
3 alturas, set de 4: 1 estructura inox satinado, + 3 bols de plástico glaseado, aprox. 1 litro
3 niveaux - set de 4: 1 structure inox poli satin, + 3 bols plastique mat, approx. 1 litre

	cm	↑ cm
11444	19 x 24	41



Multi Rack

multi rack
dispensador en escalera
support multiple



3-stufig, 4-teilig: 1 Gestell matt poliert + 1 Schütte aus transparent gefrostetem Kunststoff, ca. 1 Liter + 2 Rutschen aus transparent gefrostetem Kunststoff

3-tier, 4 pcs. set: 1 frame satin polished finish + 1 bowl frosted plastic, approx. 1 liter + 2 slides frosted plastic
3 alturas, set de 4: 1 soporte inox satinado + 1 bol de plástico glaseado, aprox. 1 litro + 2 bols con „tobogán“ en plástico glaseado
3 niveaux - set de 4: 1 structure inox poli satin + 1 bol plastique mat approx. 1 litre + 2 bols avec „toboggan“

	cm	↑ cm
11449	19 x 24	41



Multi Rack

multi rack
dispensador en escalera
support multiple



4-stufig, 5-teilig: 1 Gestell matt poliert + 4 Schütten aus transparent gefrostetem Kunststoff, je ca. 1 Liter

4-tier, 5 pcs. set: 1 frame satin polished finish + 4 bowls frosted plastic, approx. 1 liter
4 alturas, set de 5: 1 estructura inox satinado + 4 bols de plástico glaseado, aprox. 1 litro
4 niveaux - set de 5: 1 structure inox poli satin, 4 bols plastique mat, approx. 1 litre

	cm	↑ cm
11446	19 x 31	53



Multi Rack

multi rack
dispensador en escalera
support multiple



4-stufig, 5-teilig: 1 Gestell matt poliert + 3 Schütten aus transparent gefrostetem Kunststoff, je ca. 1 Liter + 1 Rutsche aus transparent gefrostetem Kunststoff

4-tier, 5 pcs. set: 1 frame satin polished finish + 3 bowls frosted plastic, approx. 1 liter + 1 slide frosted plastic

4 alturas, set de 5 piezas: 1 estructura inox satinado + 3 bols de plástico glaseado, aprox. 1 litro + 1 bol con „tobogán“ de plástico efecto glaseado

4 niveaux - set de 5 éléments: 1 structure inox poli satin + 3 bols plastique mat approx. 1 litre + 1 bol avec „toboggan“

	cm	↑ cm
11451	19 x 31	53



Schütte

Ergänzung für alle Multi-Racks

supplement for all multi racks
suplemento para todos los dispensadores
compléments pour support Multi-Rack



11455	Schütte / canister / bol / bol	
-------	--------------------------------	--



Rutsche

Ergänzung für alle Multi-Racks

supplement for all multi racks
suplemento para todos los dispensadores
compléments pour support Multi-Rack



11456	Rutsche / slide / tobogan / toboggan	
-------	--------------------------------------	--

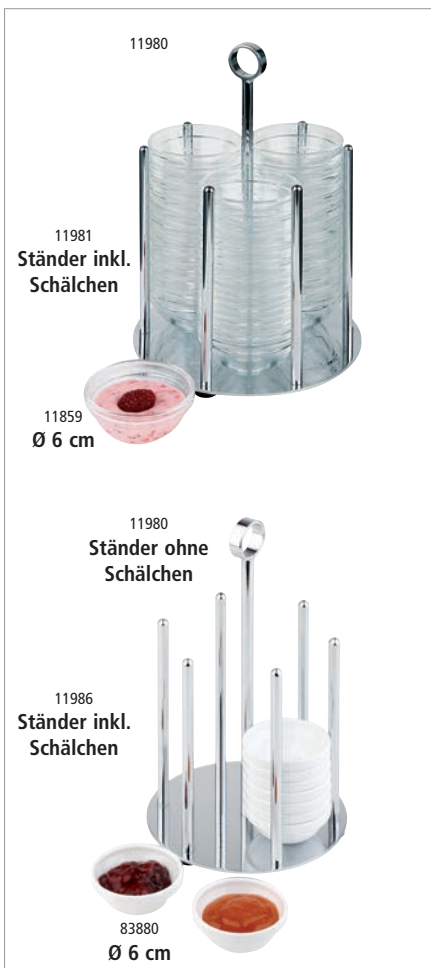

11980

11981
Ständer inkl.
Schälchen

11859
Ø 6 cm

11980
Ständer ohne
Schälchen

11986
Ständer inkl.
Schälchen

83880
Ø 6 cm

Schälchenspender „MINI“

bowl holder
rack dispensador para bols
porte-bols



geeignet für Schalen Ø 6 cm, bestückbar mit bis zu 36 Schalen

for bowls Ø 6 cm, suitable for 36 bowls

para bols de Ø 6 cm, apto para 36 bols

pour bols de Ø 6 cm, maxi 36 bols

	Ø cm	↑ cm	
11981	14	25,5	Ständer inkl. 36 Glasschalen, Ø 6 cm / frame with 36 bowls, Ø 6 cm soporte con 36 bols, Ø 6 cm / support livré avec 36 bols en verre Ø 6 cm
11986	14	25,5	Ständer inkl. 36 Melaminschalen, Ø 6 cm / frame with 36 melamine bowls, Ø 6 cm soporte con 36 bols de melamina Ø 6 cm / support avec 36 bols en mélamine Ø 6 cm

Schälchenspender „MINI“ / bowl holder / rack dispensador para bols / porte-bols

	Ø cm	↑ cm	
11980	14	25,5	Ständer ohne Schalen / frame without bowls soporte sin bols / support sans bols

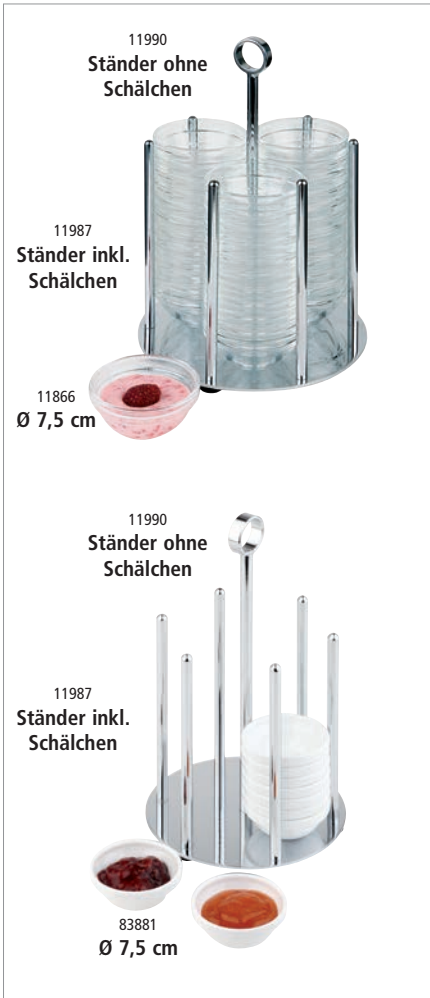

Schälchenspender „MEDIUM“

bowl holder
rack dispensador para bols
porte-bols



geeignet für Schalen Ø 7,5 cm, bestückbar mit bis zu 36 Schalen
for bowls Ø 7,5 cm, suitable for 36 bowls
para bols de Ø 7,5 cm, apto para 36 bols
pour bols de Ø 7,5 cm, maxi 36 bols

	Ø cm	↑ cm	
11991	17,5	25,5	Ständer inkl. 36 Glasschalen, Ø 7,5 cm / frame with 36 bowls, Ø 7,5 cm / soporte con 36 bols, Ø 7,5 cm / support livré avec 36 bols en verre Ø 7,5 cm
11987	17,5	22,5	Ständer inkl. 36 Melaminschalen, Ø 7,5 cm / frame with 36 melamine bowls, Ø 7,5 cm / soporte con 36 bols de melamina, Ø 7,5 cm / support avec 36 bols en mélamine Ø 7,5 cm

Schälchenspender „MEDIUM“ / bowl holder / rack dispensador para bols / porte-bols

	Ø cm	↑ cm	
11990	17,5	25,5	Ständer ohne Schalen / frame without bowls / soporte sin bols / support sans bols



Schälchen „CASUAL MINI“

bowl
cuenco
bol mini



	Ø cm	↑ cm	ltr.
83880	6,0	2,5	0,02
83881	7,5	3,5	0,05



Schale

bowl
cuenco
bol



	Ø cm	↑ cm	ltr.	pcs.
11859	6,0	2,5	0,05	36
11866	7,5	3,5	0,09	36

Buffet & Display



Vorratsglas „WOODY“

canister with lid
bote con tapa
pot en verre avec couvercle



Holzdeckel mit Silikondichtung
wooden lid with silicone gasket



Glasbehälter mit Holzdeckel, aromadichter Verschluss

glass container, aroma-tight screw cap

recipiente de cristal, tapa con cierre hermético para conservar el aroma

réipient en verre, couvercle avec fermeture hermétique pour conserver l'arôme

	cm	↑ cm	ltr.
82255	14 x 14	11,0	1,0
82256	14 x 14	17,0	2,0
82257	14 x 14	21,5	2,5



Vorratsglas „CLASSIC“

canister with lid
bote con tapa
pot en verre avec couvercle



inkl. Glasdeckel mit Dichtung. Somit bleibt Ihre Ware frisch

incl. glass lid with seal. Thus, your goods remain fresh

incl. tapa de vidrio con junta. Por lo tanto, sus productos permanecen frescos

y compris couvercle en verre avec joint. Ainsi, vos marchandises restent fraîches

	Ø cm	↑ cm	ltr.
82250	11,5	16,0	0,9
82251	14,0	21,5	2,0
82252	18,0	26,0	4,0
82253	20,0	30,0	6,0



2 ltr.

Vorratsglas mit luftdichtem Klappdeckel

glass with airtight cover
bote con cierre hermético
pot en verre avec fermeture hermétique



	cm	↑ cm	ltr.
82328	12 x 12	22	2



3 ltr.

inkl. Löffel

Vorratsglas

canister with lid
bote con tapa
pot en verre avec couvercle



Glaskugel mit Löffel, Schraubdeckel mit aromadichtem Verschluss, Edelstahl-Löffel mit magnetischem Silikongriff, 1 Stck.
tight cover, stainless steel spoon with magnetic silicone handle, 1 pc.
tapa a rosca con cierre hermético, cuchara de acero inoxidable con mango de silicona magnético, 1 pza
couvercle à vis avec fermeture hermétique, cuillère en acier inox avec manche de silicone aimanté, 1 pc.

	Ø cm	↑ cm	ltr.
00636	20	18	3



1 ltr.

Vorratsglas

canister with lid
bote con tapa
pot en verre avec couvercle



Glaskugel mit Schraubdeckel, aromadichtem Verschluss, 1 Stck.
glass ball, aroma-tight screw cap, 1 pc.
bote de cristal, tapa a rosca para conservar el aroma, 1 pza
pot en verre, couvercle à vis pour conserver l'arôme, 1 pc.

	cm	↑ cm	ltr.
00637	12,5 x 19	18	1

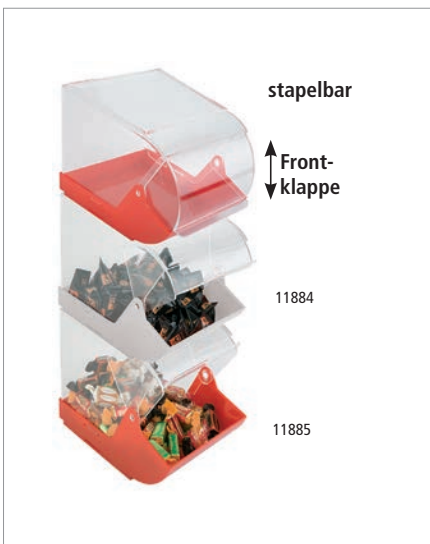

stapelbar

Frontklappe

11884

11885

Universalbox

box / sweetbox
caja dispensadora
boîte distributrice



ideal als Verkaufsbox, mit Frontdeckel
best to present sweets etc., all-purpose, with front lid
la perfecta solución para presentar golosinas, universal, con tapa frontal
la solution idéale pour les friandises et autres, universel, avec couvercle frontal

	cm	↑ cm	Farbe / Colour
11884	23 x 14,5	15	White
11885	23 x 14,5	15	Red

Buffet & Display



Hygieneschutz

hygienic cover
cubierta higiénica antialiento
pare-haleine



	cm	↑ cm
11556	82 x 42	45



Brötchenspender

roll dispenser
dispensador de panecillos
distributeur de petits pains



hygienisch und einfach zu reinigen, mit Krümelschale

hygienic and easy to clean, with crumb tray
higiénico y fácil de limpiar, con bandeja para migas
hygiénique et facile à laver, avec plat ramasse-miettes

	cm	↑ cm	
11572	32,5 x 27,5	42	für ca. 45 - 50 Brötchen / for approx. 45 - 50 rolls para 45-50 panecillos / pour 45-50 petits pains
11573	32,5 x 27,5	56	für ca. 65 - 70 Brötchen / for approx. 65 - 70 rolls para 65-70 panecillos / pour 65-70 petits pains

Deckel / Cover / tapa / couvercle seul

	cm	↑ cm
11562	33,5 x 21,5	4



Universalbox

universal box
caja dispensadora
boî distributrice



ideal für Zucker, Milch und Gebäck, 3 Fächer

best for sugar, milk and biscuits, 3 compartments
la perfecta solución para a azúcar, leche y galletas, 3 compartimentos
la solution idéale pour sucre, lait et biscuits, 3 compartiments

	cm	↑ cm
11886	41,5 x 20,5	16



Teebox / Multibox

tea caddy
caja para té
boîte à thés et infusions



3 Fächer für kuvertierte Teebeutel, 1 Fach für Zucker, Kekse, etc., Deckel aufklappbar

4 chambers
4 compartimentos
4 compartiments

	cm	↑ cm
11563	22 x 17	9



NEW

Teebox „VINTAGE“

tea-box
caja para té
boîte à thés et infusions



Holzbox mit Sichtfenster, 4 Kammern können mit je 30 kuvertierten Teebeuteln bestückt werden

wooden box with clear transparent window, 4 chambers for approx. 30 tea bags each
caja de madera clara con ventana transparente, 4 compartimentos, para aproximadamente 30 bolsas de té
en bois clair avec fenêtre, 4 compartiments, pour environ 30 sachets

	cm	↑ cm	Farbe / Colour
11570	32 x 20	10	■



NEW

Teebox „VINTAGE“

tea-box
caja para té
boîte à thés et infusions



Holzbox mit Sichtfenster, 4 Kammern können mit je 30 kuvertierten Teebeuteln bestückt werden

wooden box with clear transparent window, 4 chambers for approx. 30 tea bags each
caja de madera clara con ventana transparente, 4 compartimentos, para aproximadamente 30 bolsas de té
en bois clair avec fenêtre, 4 compartiments, pour environ 30 sachets

	cm	↑ cm	Farbe / Colour
11571	32 x 20	10	■



11575

11574

Teebox

tea-box
caja para té
boîte à thés et infusions



Holzbox mit Sichtfenster, mit Aufschrift „Tee“, 4 Kammern können mit je 30 kuvertierten Teebeuteln bestückt werden

wooden box with clear transparent window, with inscription „Tee“, 4 chambers for approx. 30 tea bags each
caja de madera clara con ventana transparente, con inscripción „Tee“, 4 compartimentos, para aproximadamente 30 bolsas de té
en bois clair avec fenêtre, marquée „TEE“, 4 compartiments, pour environ 30 sachets

	cm	↑ cm	Farbe / Colour
11575	33,5 x 20	9	■
11574	33,5 x 20	9	■

	cm	↑ cm	Farbe / Colour	
11576	33,5 x 20	9	■	ohne Aufschrift / without inscription sin inscripción / sans inscription



11775

11776

Teebox

tea-box
caja para té
boîte à thés et infusions



Holzbox mit Sichtfenster, mit Aufschrift „Tee“, 12 Kammern können mit je 12 kuvertierten Teebeuteln bestückt werden

wooden box with clear transparent window, with inscription „Tee“, 12 chambers for approx. 144 tea bags each
caja de madera clara con ventana transparente, con inscripción „Tee“, 12 compartimentos, para aproximadamente 144 bolsas de té
en bois clair avec fenêtre, marquée „TEE“, 12 compartiments, pour environ 144 sachets

	cm	↑ cm	Farbe / Colour
11775	31 x 28	9	■
11776	31 x 28	9	■

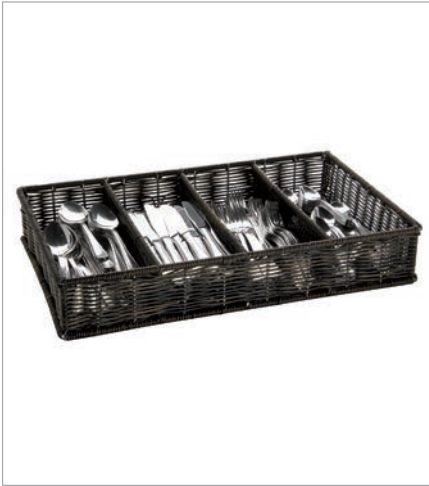

GN 1/1 Besteckbehälter

GN 1/1 dispenser GN
GN 1/1 dispensador de cubiertos
GN 1/1 bac à couverts



in Handarbeit geflochten, 4 Mulden, Kunststoff-Geflecht, Drahtgestell, braun-schwarz

wickerwork, 4 compartments, with reinforced chromed wire structure, brown-black

cesta trensada a mano, 4 compartimentos, de plástico, con bastidor cromado reforzado, marrón oscuro

corbeille tressée à main, 4 compartiments, en plastique, cadre acier chromé renforcé, couleur marron foncé

	cm	↑ cm	Farbe / Colour
11966	53 x 32,5	9	



GN 1/1 Besteckbehälter „BUFFET“

GN 1/1 cutlery dispenser
GN 1/1 dispensador de cubiertos
GN 1/1 bac à couverts



4 Mulden, Kunststoff-Geflecht, Drahtgestell, beige

4 troughs, wickerwork, wire, beige

4 huecos, trabajo de cestería

4 compartiments, plastique tressé, cadre acier chromé renforcé, couleur osier naturel

	cm	↑ cm	Farbe / Colour
11965	53 x 32,5	10	



GN 1/1 Besteckbehälter

GN 1/1 cutlery tray / box stand
GN 1/1 dispensador de cubiertos
GN 1/1 bac à couverts



	cm	↑ cm	Farbe / Colour
11955	53 x 32,5	10	



GN 1/1 Besteckkasten

cutlery box GN 1/1
GN 1/1 dispensador de cubiertos
GN 1/1 bac à couverts



	cm	↑ cm	Farbe / Colour
11960	53 x 32,5	10	





Besteckköcher
cutlery basket
cesta para cubiertos
corbeille à couverts



	Ø cm	↑ cm	
11998	9,7	13,7	Kunststoff weiß / white plastic plástico blanco / plastique blanc
11999	9,7	13,7	matt poliert / satin polished finish acero inoxidable / inox

11998
Köcher weiß
PE white

11999
Köcher Edelstahl
stainless steel



Besteckbehälter
cutlery basket
dispensador de cubiertos
présentoir à couverts



matt poliert
satin polished finish
inox mate (sin cubiertos)
inox mat

	cm	↑ cm	
11994	26,0 x 30 Ø 10	20	4 Löcher inkl. Köcher (Kunststoff) 4 holes incl. dispensers (plastic) 4 agujeros incl. dispensador plástico 4 places, avec 4 récipients (plastique)
11997	37,5 x 30 Ø 10	20	6 Löcher ohne Köcher 6 holes without dispensers 6 agujeros sin dispensador de plástico 6 places, sans récipients

11994

11997



Besteckbehälter
cutlery basket
recipiente para cubiertos
récipients pour couverts



4 Löcher inkl. 4 Edelstahl Köcher
4 holes incl. 4 stainless baskets
4 agujeros, incl. 4 cestas de acero
4 places, avec 4 corbeilles inox

	cm	↑ cm	Farbe / Colour
93321	27 x 27	15	



Besteckbehälter „ELEMENT“
cutlery bin
recipiente para cubiertos
récipients pour couverts



mit Abflussloch, mit Besteck Logo, Bodeneinlage aus Silikon zum Schonen des Bestecks, möbelschonende Unterseite
with drain hole, with cutlery logo, silicone floor insert for saving the cutlery, with non-scratching undersurface
con orificio de drenaje, con logotipo de cubertería, base de silicona para proteger la cubertería, con base anti rayaduras
avec trou de drainage, avec logo de coutellerie, insert de silicone pour protéger la coutellerie, avec revêtement antirayures

	Ø cm	↑ cm
00018	11	14



Besteckbehälter „ELEMENT“

cutlery bin
recipiente para cubiertos
récipients pour couverts



mit Abflussloch, mit weißem Logo, Bodeneinlage aus Silikon zum Schonen des Bestecks, möbelschonende Unterseite
with drain hole, with white logo, silicone floor inserts for saving the cutlery, with non-scratching undersurface
con orificio de drenaje, con logotipo blanco, base de silicona para proteger la cuberteria, con base anti rayaduras
avec trou de drainage, avec logo blanc, insert de silicone pour proteger la coutellerie, avec revêtement antirayures

	Ø cm	↑ cm	Logo
11935	12	14	fork
11936	12	14	knife
11937	12	14	spoon



Besteckbehälter „ACACIA“

cutlery bin
recipiente para cubiertos
récipients pour couverts



Akazienholz natur
acacia wood nature
madera de acacia natural
bois d'acacia naturelle

	cm	↑ cm	Logo
11939	14 x 14	15	fork / knife / spoon

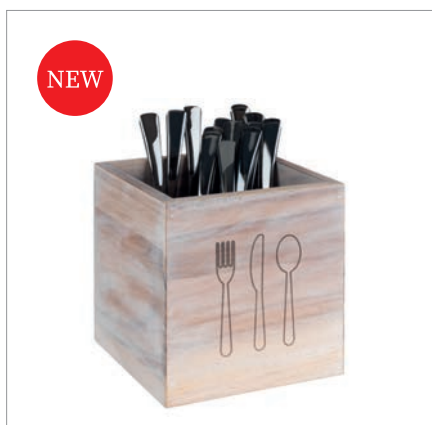

Besteckbehälter „VINTAGE“

cutlery bin
recipiente para cubiertos
récipients pour couverts



Akazienholz vintage weiß
acacia wood, vintage white
madera de acacia, blanca vintage
bois d'acacia, blanc vintage

	cm	↑ cm	Logo
11938	14 x 14	15	fork / knife / spoon



02039

Tischrestebehälter
table garage bin
papelera de sobremesa
poubelle de table



	Ø cm	↑ cm	ltr.	Farbe / Colour
02038	11	14	0,9	White
02039	11	14	0,9	Black



Tischrestebehälter „INTERNATIONAL“
table waste bin
papelera de sobremesa
poubelle de table



Deckel-Ring mit Dichtung, internationale Beschriftung
cover with sealing ring
tapa con junta, texto multi-idomas
couvercle avec joint, texte multilingue

	Ø cm	↑ cm	ltr.
83847	10	17,5	1



Tischrestebehälter
table garbage bin
papelera de sobremesa
poubelle de table



Behälter aus weiß lackiertem Metall, abnehmbarer Schwingdeckel
cover stainless steel bin metal, white, swing cover
tapa de acero inoxidable, recipiente chapa lacada blanca
couvercle inox basculant, récipient en acier laqué blanc

	Ø cm	↑ cm	ltr.
00291	12	17	1,2



Tischrestebehälter
table garbage bin
papelera de sobremesa
poubelle de table



Behälter aus weiß lackiertem Metall, Edelstahl-Lochdeckel
metall white, stainless cover with hole
tapa, acero inoxidable, con apertura
couvercle inox, avec ouverture centrale, récipient en acier laqué blanc

	Ø cm	↑ cm	ltr.
00292	12	15	1,2



Tischrestebehälter „SUNDAY“
table waste bin
papelera de sobremesa
poubelle de table



matt poliert, inkl. Deckel, fester Deckelsitz
satin polished finish, incl. cover, cover removeable
acero inoxidable mate, con tapa
inox mat, avec couvercle

	Ø cm	↑ cm	ltr.
00024	10	18	1,1



Tischrestebehälter

table garbage bin
papelera de sobremesa
poubelle de table



Behälter (innen Ø 9 cm) für Besteck, Servietten etc., vielseitig einsetzbar
bins (inner Ø 9 cm) for cutlery, napkins etc., versatile applicable
recipientes Ø 9 cm para cubiertos, servilletas etc.
récipients Ø 9 cm, pour couverts, serviettes,...

	Ø cm	↑ cm	ltr.
83999	13	14	1,2



Tischreste- / Besteckbehälter

table garbage bin / cutlery bin
papelera de sobremesa / recipiente para cubiertos
poubelle de table / récipients pour couverts



matt poliert, mit abnehmbaren Lochdeckel
satin polished finish, with removeable cover
acabado pulido satinado, con tapa desmontable
poli mat satiné, avec couvercle démontable ouvert au centre

	Ø cm	↑ cm	ltr.
00028	10	12	0,7



Tischrestebehälter

table garbage bin
papelera de sobremesa
poubelle de table



matt poliert, abnehmbarer Schwingdeckel, mit Bajonettverschluss „fester Deckelsitz“
satin polished finish, swing cover, cover removable
acabado satinado, tapa basculante desmontable
poli mat satiné, couvercle basculant démontable

	Ø cm	↑ cm	ltr.
00029	12	17	1,2
00027	10	13	0,7



Table Caddy „COUNTRY STYLE“

table barrel
caddy de mesa
caddy de table



cooler Country-Style, nicht für den direkten Kontakt mit Lebensmittel verwendbar
make for cool condiment and cutlery holders or even for food presentation, the mini barrels should not come into contact with food, they should be lined with our greaseproof paper
estilo campo, no aptos para el contacto directo con alimentos, sólo usando papel alimenticio
de style champêtre, pas de contact direct avec aliments, seulement en utilisant papier alimentaire

	Ø cm	↑ cm
11930	17,5	8,5
11931	11,5	14,0





Tischreste- / Besteckbehälter „TOP CHROME“

table waste bin / cutlery bin
 papelera de sobremesa / recipiente para cubiertos
 poubelle de table / récipients pour couverts



mit verchromten Rand
 with chrome plated ring
 con anillo cromado
 avec bord chromé

	Ø cm	↑ cm	ltr.	Farbe / Colour
00025	13	15	1	White
00026	13	15	1	Black



Tischreste- / Besteckbehälter „BASE CHROME“

table waste bin / cutlery bin
 papelera de sobremesa / recipiente para cubiertos
 poubelle de table / récipients pour couverts



mit verchromten Boden
 with chrome bottom
 con base cromada
 avec base chromée

	Ø cm	↑ cm	ltr.	Farbe / Colour
00019	13	15	1,3	White
00020	13	15	1,3	Black



Besteckständer „TRIPLE TOWER“

cutlery basket
 cesta para cubiertos
 égouttoir à couverts



4-teiliges Set: 1 Gestell + 3 Köcher
 4 pcs. set: 1 frame + 3 baskets
 set de 4: 1 estructura + 3 cubiertos
 set de 4: 1 structure + 3 corbeilles

	cm	↑ cm	Farbe / Colour
11466	18 x 26	43	White
11467	18 x 26	43	White

variable Nutzungsmöglichkeiten
 variable usage possibilities



Besteckköcher

cutlery basket
 cesta para cubiertos
 corbeille à couverts



Abtropflöcher
 drainer
 holes

	cm	↑ cm	Farbe / Colour
84535	12 x 12	16	White
84536	12 x 12	16	Black



Tischkrümelentferner

crumber
 recogemigas
 ramasse-miettes



matt poliert
 satin polished finish
 acabado mate, fácil de usar, mango hueco
 mat satiné, manche creux, simple à utiliser

	Ø cm	↑ cm	
00058	6,5 x 2,5	22	Hohlgriff / hollow handles
00581	19,0 x 4,5	1	geschliffene Edelstahlkante flat grinded stainless steel edge



hot price

Tischrestebehälter
table garbage bin
papelera de sobremesa
poubelle de table



	Ø cm	↑ cm	litr.
00311	14	15	1,2



hot price

Tischrestebehälter
table garbage bin
papelera de sobremesa
poubelle de table



Kunststoff weiß / Granit, abnehmbarer Schwingdeckel
white plastic, swing cover, cover removable
plástico blanco/granito, tapa basculante desmontable
plastique blanc/gris chiné, couvercle basculant démontable

	Ø cm	↑ cm	litr.
00031	12	18	1,4



matt poliert
satin polished finish

10 cm

13,5 cm

11921

11922

Besteckständer
cutlery basket
cesta para cubiertos
égouttoir à couverts



	Ø cm	↑ cm
11921	10	10,0
11922	12	13,5



Tischreste- / Besteckbehälter
table waste bin / cutlery bin
papelera de sobremesa / recipiente para cubiertos
poubelle de table / récipients pour couverts



mit verchromten Rand, inkl. herausnehmbarem Einteiler (4 Fächer)
with chrome plated ring, incl. divider (4 chambers)
con anillo cromado, incl. divisor extraíble (4 compartimentos)
avec bod chrome, incl. paroi de separation amovible (4 compartiments)

	cm	↑ cm
00016	14 x 14	16

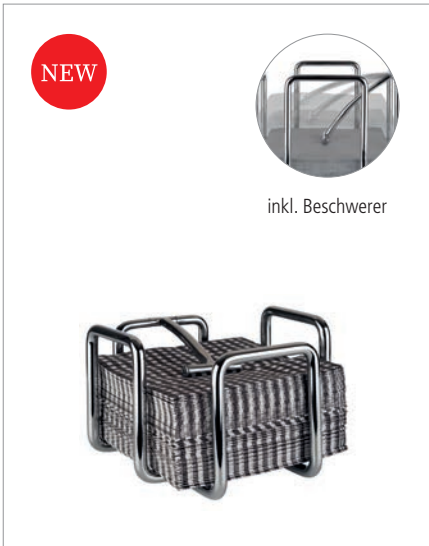

Serviettenhalter „HERO“

napkin holder
servilletero
porte-serviettes



für ca. 65 Cocktailservietten, inkl. Beschwerer
for approx. 65 cocktail napkins, incl. weight
para aprox. 65 servilletas cocktail, incl. barra de contrapeso
pour environ 65 serviettes cocktail, incl. barre de contrepoids

	cm	↑ cm	
11767	14,5 x 14,5	10	für 65 Servietten / for 65 napkins para 65 servilletas / pour 65 serviettes



Serviettenhalter „HERO“

napkin holder
servilletero
porte-serviettes



für ca. 95 Servietten 1/4 Falz, inkl. Beschwerer
for approx. 95 cocktail napkins, incl. weight
para aprox. 95 servilletas cocktail, incl. barra de contrapeso
pour environ 95 serviettes cocktail, incl. barre de contrepoids

	cm	↑ cm	
11768	18,5 x 18,5	14	für 95 Servietten / for 95 napkins para 95 servilletas / pour 95 serviettes



Serviettenhalter „PROFI“

napkin holder
servilletero
porte-serviettes



für 150 Servietten 1/4 Falz, inkl. Beschwerer, mit Antirutschfüßchen, absolut standfest
for 150 napkins 1/4 fold, incl. weight, non-slip feet, very stable
para 150 servilletas plegado 1/4, incl. barra de contrapeso, con pies antideslizantes, muy estable
pour 150 serviettes pliage 1/4, incl. barre de contrepoids, avec pieds antidérapants, très stable

	cm	↑ cm	
11766	18,5 x 18,5	18	für 150 Servietten / for 150 napkins para 150 servilletas / pour 150 serviettes



Serviettenhalter

napkin holder
servilletero
porte-serviettes



hochglanzpoliert, für Servietten mit 1/8 Falz, Füße mit rutsch- und kratzfester Gummierung
mirror polished finish, for napkins with 1/8 fold, rubber feet
pulido brillante, para servilletas plegado 1/8, con revestimiento de goma
poli miroir, pour serviettes pliage 1/8, avec revêtement en caoutchouc

	cm	↑ cm	
11720	10 x 11,5	18,5	



Serviettenhalter „ELEMENT“

napkin holder
servilletero
porte-serviettes



aus Beton, für ca. 50 Servietten, mit möbelschonender Unterseite
concrete, for approx. 50 napkins, with furniture-friendly underside
hormigón, para aprox. 50 servilletas, con base anti rayaduras
béton, pour environ 50 serviettes, avec revêtement antirayures

	cm	↑ cm	
11781	16 x 7,5	10	für 50 Servietten / for 50 napkins para 50 servilletas / pour 50 serviettes



Serviettenhalter „WIRE“

napkin holder
servilletero
porte-serviettes



für Servietten 1/4 Falz, inkl. Beschwerer
for napkins 1/4 fold, incl. weight
para servilletas plegado 1/4, incl. barra de contrapeso
pour serviettes pliage 1/4, incl. barre de contrepoids

	cm	↑ cm	
11763	19 x 19	6,5	für 50 Servietten / for 50 napkins para 50 servilletas / pour 50 serviettes
11765	19 x 19	19,0	für 150 Servietten / for 150 napkins para 150 servilletas / pour 150 serviettes



Serviettenhalter „BAR“

napkin holder
servilletero
porte-serviettes



für ca. 50 Cocktailservietten, inkl. Beschwerer
for approx. 50 cocktail napkins, incl. weight
para aprox. 50 servilletas cocktail, incl. barra de contrapeso
pour environ 50 serviettes cocktail, incl. barre de contrepoids

	cm	↑ cm	
11762	14 x 14	6,5	für 50 Servietten / for 50 napkins para 50 servilletas / pour 50 serviettes



Serviettenhalter

napkin holder
servilletero
porte-serviettes



matt poliert
satin polished finish
acabado satinado
mat satiné

	cm	↑ cm	
11730	17 x 17	5	



Serviettenhalter

napkin holder
servilletero
porte-serviettes



möbelschonende Unterseite, für ca. 30 Servietten, matt poliert
furniture-friendly underside, for approx. 30 napkins, satin polished finish
con base anti rayaduras, para aprox. 30 servilletas, pulido mate
avec revêtement antirayures, pour environ 30 serviettes, poli mat

	cm	↑ cm	
11780	15 x 4,5	12,5	für 30 Servietten / for 30 napkins para 30 servilletas / pour 30 serviettes



Serviettenhalter

napkin holder
servilletero
porte-serviettes



möbelschonende Unterseite, für ca. 20 Servietten, matt poliert
furniture-friendly underside, for approx. 20 napkins, satin polished finish
con base anti rayaduras, para aprox. 20 servilletas, pulido mate
avec revêtement antirayures, pour environ 20 serviettes, poli mat

	cm	↑ cm	
11778	17 x 3	7	für 20 Servietten / for 20 napkins para 20 servilletas / pour 20 serviettes



11631

Holzbox „VINTAGE“

woodbox
caja madera
base bois



Schubladenoptik, mit Knopf
drawer look, with knob
look cajón, con pomo
look tiroir, avec bouton

	cm	↑ cm	
11631	18,5 x 18,5	11	Innenmaß: 17 x 17 cm, mit Beschriftungsfach
11633	18,5 x 18,5	11	Innenmaß: 17 x 17 cm, mit Beschriftungsfach



11633





Buffet & Tableware Melamin

Tablets
Schalen
Teller
Fingerfood
Eierbecher

bandejas
cuencos
platos
finger food
hueveras

trays
bowls
plates
finger food
egg holders

plateaux
bols
assiettes
finger food
coquetiers

NEW HAPPY BUFFET

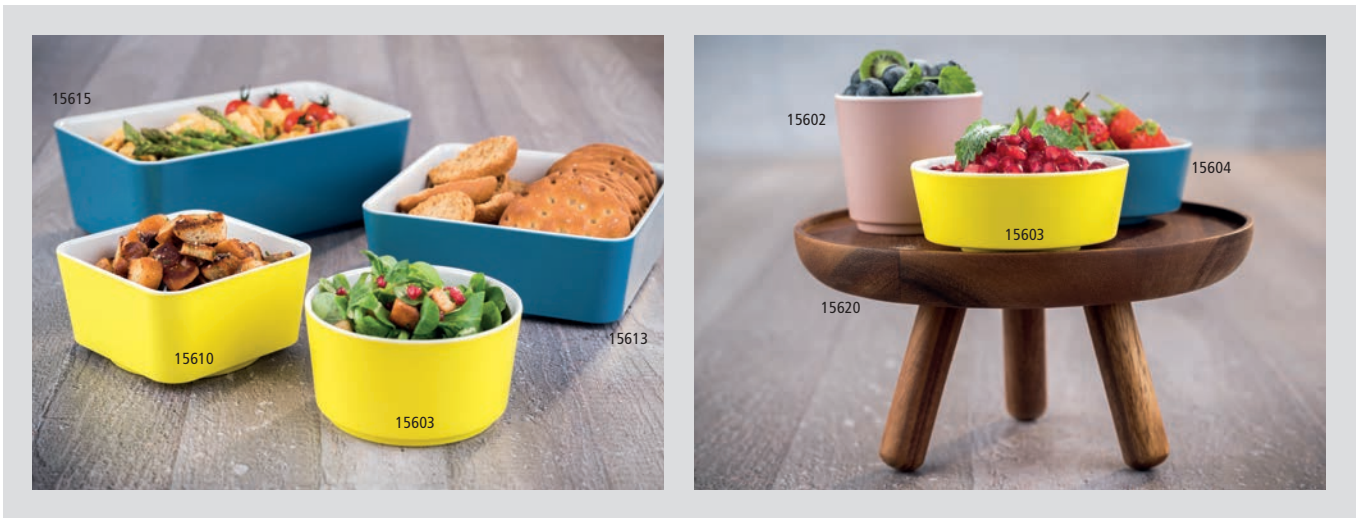

Schale „HAPPY BUFFET“

bowl, square
cuenco cuadrado
bol carré



	cm	↑ cm	ltr.	Farbe / Colour
15610	13 x 13	7	0,6	
15611	13 x 13	7	0,6	
15612	20 x 20	7	1,5	
15613	20 x 20	7	1,5	

Deckel „UNIVERSAL“ mit Löffelaussparung / cover with notched for spoons / tapa con espacio para la cuchara / couvercle avec encoche pour la louche

	cm	↑ cm	fits to
15345	20 x 20	1,5	15612, 15613



GN 1/4 Schale „HAPPY BUFFET“

GN 1/4 bowl
GN 1/4 cuenco
GN 1/4 bol



	cm	↑ cm	GN	ltr.	Farbe / Colour
15614	26,5 x 16,2	9	1/4	2,5	
15615	26,5 x 16,2	9	1/4	2,5	

Deckel „UNIVERSAL“ mit Löffelaussparung / cover with notched for spoons / tapa con espacio para la cuchara / couvercle avec encoche pour la louche

	cm	↑ cm	GN	fits to
15348	26,5 x 16,2	1,5	1/4	15614, 15615





Schale, rund „HAPPY BUFFET“

bowl, round
cuenco, redondo
bol rond



	Ø cm	↑ cm	litr.	Farbe / Colour
15600	6,5	6	0,15	
15601	6,5	6	0,15	
15602	6,5	6	0,15	
15603	9,0	4	0,15	
15604	9,0	4	0,15	
15605	9,0	4	0,15	
15606	13,0	7	0,60	
15607	13,0	7	0,60	
15608	20,0	7	1,50	
15609	20,0	7	1,50	



Deckel „UNIVERSAL“ mit Löffelaussparung / cover with notched for spoons / tapa con espacio para la cuchara / couvercle avec encoche pour la louche

	Ø cm	↑ cm	fits to
15341	20	1,5	15608, 15609



Buffetständer „ACACIA“

buffet stand
soporte para buffet
présentoir buffet



Akazienholz geölt / acacia wood oiled / madera de acacia aceitada / bois d'acacia huilé

	Ø cm	↑ cm
15620	20,0	10,5
15621	30,5	15,0
15622	30,5	20,0



Buffetständer „ACACIA“

buffet stand
soporte para buffet
présentoir buffet



Akazienholz geölt / acacia wood oiled / madera de acacia aceitada / bois d'acacia huilé

	cm	↑ cm	GN
15623	53 x 16,2	20	2/4

APS+

UNIVERSAL



⊕ Kompatibilität / compatibility / combinación / compatibilité

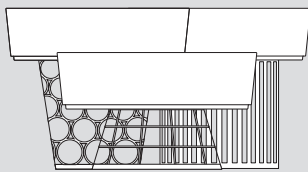

Baskets
risers

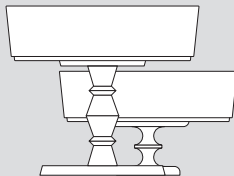

Wood
risers

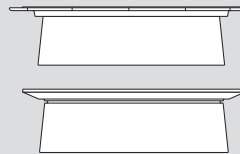

Bakery / Wood
plates

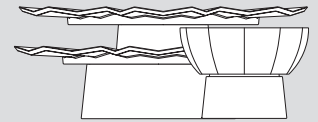

Lotus
bowls / plates



weiß; innen glänzend, außen matt
white; glossy on the inside, matt on the outside
blanco; interior brillante, exterior mate
blanc; intérieur brillant, extérieur mat



Holzdekor Ahorn & Farbe
maple wood decor & colour
textura de madera arce & color
aspect érable & couleur

bicolor
bicolour
bicolor
bicolore



Holzdekor Eiche dunkel & Farbe
oak wood decor & colour
textura de madera roble oscuro & color
aspect chêne foncé & couleur

bicolor
bicolour
bicolor
bicolore



Holzdekor Ahorn & cream

Holzdekor Eiche & cream

Holzdekor Ahorn & red

Holzdekor Eiche & red

Holzdekor Ahorn & green

Holzdekor Eiche & green

Holzdekor beige & cream

Holzdekor brown & cream



15116

GN 1/4 Schale „UNIVERSAL“

GN 1/4 bowl
GN 1/4 cuenco
GN 1/4 bol



	cm	↑ cm	GN	litr.	Farbe / Colour
15116	26,5 x 16,2	7	1/4	1,5	White
15117	26,5 x 16,2	9	1/4	2,5	White



15111

Schale, quadratisch „APS+“

bowl, square
cuenco cuadrado
bol carré



	cm	↑ cm	ltr.	Farbe / Colour
15110	6,5 x 6,5	6	0,15	_____
15111	9,0 x 9,0	4	0,15	_____
15112	13,0 x 13,0	7	0,60	_____



15115

Schale, quadratisch „APS+“

bowl, square
cuenco cuadrado
bol carré



	cm	↑ cm	ltr.	Farbe / Colour
15113	20,0 x 20,0	7	1,5	_____
15114	24,0 x 24,0	9	3,5	_____
15115	26,5 x 26,5	9	4,0	_____



15100

15102

Schale, rund „UNIVERSAL“

bowl, round
cuenco, redondo
bol rond



	Ø cm	↑ cm	ltr.	Farbe / Colour
15100	6,5	6	0,15	_____
15101	9,0	4	0,15	_____
15102	13,0	7	0,60	_____



15104

Schale, rund „UNIVERSAL“

bowl, round
cuenco, redondo
bol rond



	Ø cm	↑ cm	ltr.	Farbe / Colour
15103	16,0	12	1,5	_____
15104	16,0	15	2,5	_____



15106

15108

Schale, rund „UNIVERSAL“

bowl, round
cuenco, redondo
bol rond



	Ø cm	↑ cm	ltr.	Farbe / Colour
15105	20,0	7	1,5	_____
15106	24,0	9	2,7	_____
15108	32,5	9	4,0	_____

Buffet & Tableware Melamin



GN 1/4 Schale „APS+“

GN 1/4 bowl
GN 1/4 cuenco
GN 1/4 bol



	cm	↑ cm	GN	ltr.	Farbe / Colour
15219	26,5 x 16,2	7	1/4	1,5	
15220	26,5 x 16,2	9	1/4	2,5	
15234	26,5 x 16,2	7	1/4	1,5	
15235	26,5 x 16,2	9	1/4	2,5	



Schale, quadratisch „APS+“

bowl, square
bol cuadrado
plat creux carré



	cm	↑ cm		ltr.	Farbe / Colour
15215	13,0 x 13,0	7		0,6	
15216	20,0 x 20,0	7		1,5	
15217	24,0 x 24,0	9		3,5	
15218	26,5 x 26,5	9		4,0	
15232	20,0 x 20,0	7		1,5	
15233	26,5 x 26,5	9		4,0	



Schale, rund „APS+“

bowl, round
cuenco, redondo
bol rond



	Ø cm	↑ cm		ltr.	Farbe / Colour
15230	20,0	7		1,5	
15231	32,5	9		4,0	



Schale „APS+“

bowl
cuenco
bol



	Ø cm	↑ cm		ltr.	Farbe / Colour
15200	6,5	6		0,15	
15201	9,0	4		0,15	



Schale „APS+“

bowl
cuenco
bol



	cm	↑ cm		ltr.	Farbe / Colour
15204	6,5 x 6,5	6		0,15	
15205	9,0 x 9,0	4		0,15	

APS+

ANTI PASTI



Buffet & Tableware
Melamin

+ Kompatibilität / compatibility / combinación / compatibilité

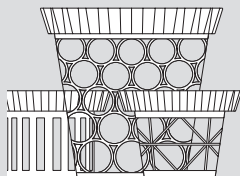

Baskets
risers

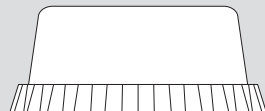

Cover
seal

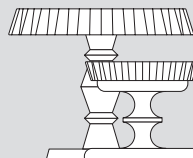

Wood
risers

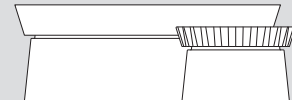

Bowls
risers



Schale „APS+ PLISSEE“

bowl
cuenco
bol



	Ø cm	↑ cm	Farbe / Colour
15142	35	4	White



Schale „APS+“

bowl
cuenco
bol



	Ø cm	↑ cm	Farbe / Colour
15135	14,5	2,5	White
15136	25,0	3,5	White
15137	35,0	4,0	White



Schale Water Lily „APS+“

leaf
fuente en forma de hoja
plat feuille



	Ø cm	↑ cm	litr.	Farbe / Colour
15165	8,5	4	0,10	White
15166	13,0	6	0,30	White
15167	20,0	7	1,25	White

0,10 ltr.
15165

1,25 ltr.
15167



✚ Kompatibilität / compatibility / combinación / compatibilit 

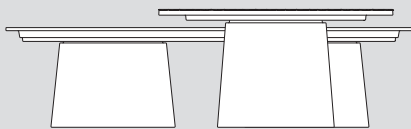

Bowls
risers

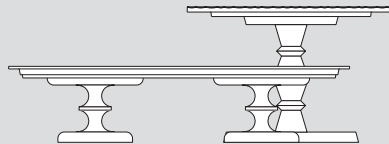

Wood
risers

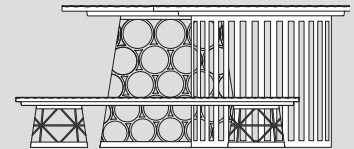

Baskets
risers



GN Tablett TILES „APS+“

GN tray
GN bandeja
GN plateau



	cm	↑ cm	GN	Farbe / Colour
15250	26,5 x 16,2	1,5	1/4	■
15251	32,5 x 17,5	1,5	1/3	■
15253	32,5 x 26,5	1,5	1/2	■
15252	53,0 x 16,2	1,5	2/4	■





GN Tablett TILES „APS+“

GN tray
GN bandeja
GN plateau



	cm	↑ cm	GN	Farbe / Colour
15225	26,5 x 16,2	1,5	1/4	
15226	32,5 x 17,5	1,5	1/3	
15228	32,5 x 26,5	1,5	1/2	
15227	53,0 x 16,2	1,5	2/4	



Korb / Ständer „BASKET“

basket / riser
cesta / soporte
corbeille / support



	Ø cm	↑ cm	Farbe / Colour
15320	10,5 / 8	8	
15324	10,5 / 8	8	
15322	10,5 / 8	8	

+ Kompatibilität / compatibility / combinación / compatibilité

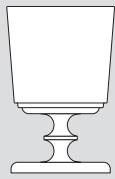

Universal
bowls

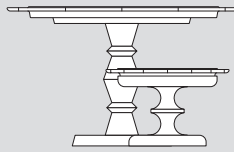

Tiles
plates

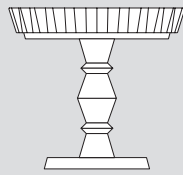

Antipasti
flat bowls

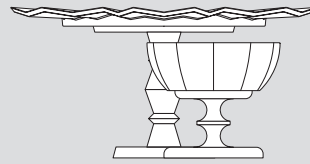

Lotus
plates / bowls

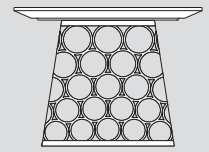

Baskets
risers



15300

Tablett WOOD „APS+“

tray
bandeja
plateau



	Ø cm	↑ cm	Farbe / Colour
15300	30,0	2	
15302	38,5	2	



15303

Tablett WOOD „APS+“

tray
bandeja
plateau



	Ø cm	↑ cm	Farbe / Colour
15301	30,0	2	
15303	38,5	2	



15310

Ständer WOOD „APS+“

stand
soporte
support



	Ø cm	↑ cm	Farbe / Colour
15310	15 / 11,5	10,5	
15311	15 / 11,5	10,5	



15313

Ständer WOOD „APS+“

stand
soporte
support



	Ø cm	↑ cm	Farbe / Colour
15312	21 / 15	20	
15313	21 / 15	20	



Frischhalte-Haube „APS+“

cover
campana
cloche bombée



glasklar, Griff verchromt, schwere, stabile Ausführung

transparent, chrome knob, heavy stable quality
transparente, asa cromada, alta estabilidad
transparente, anse chromée, très stable

	Ø cm	↑ cm	✱ mm	fits to
15350	16,5	10	3	15130
15351	20,5	10	3	15141, 15136, 15271, 15131



Frischhalte-Haube

cover
campana
cloche



	Ø cm	↑ cm	fits to
06512	30	11,5	15142, 15137, 15272, 15132
06517	33	12,5	15133, 15302, 15303



Rolltophaube

rolltop cover
campana abatible
cloche basculante



glasklarer Kunststoff, leichtgängig auf- und zuklappen 90°

solid quality, to be opened 90°
plástico transparente de alta calidad, apertura a 90°
plastique transparent résistant, ouverture 90°

	Ø cm	↑ cm	fits to
18388	38	20	15302, 15303



Haube

cover
campana
cloche



	Ø cm	↑ cm	fits to
06519 <small>new</small>	21	17	15312, 15313
06520	30	22	15300, 15301
06521 <small>new</small>	36	27	15302, 15303

ASIA+



Nahezu alle ASIA+ Produkte verfügen über ein System von Ringen und Radien und können dadurch stand- und rutschfest miteinander kombiniert werden. So können beispielsweise alle Schalen auch als Riser / Aufsteller für unterschiedlichste weitere ASIA+ Produkte verwendet werden.

Nearly all ASIA+ products feature a system of rings and radii that allow them to be combined with each other in a stable manner. For example, all bowls can be used as risers for a wide range of other ASIA+ products. The same applies to the baskets.

Casi todos los productos de ASIA+ disponen de un sistema de anillos y radios que permiten su combinación entre sí con una estabilidad perfecta. Así por ejemplo, todos los cuencos se pueden utilizar también como pedestales para los productos más diversos de ASIA+. Y lo mismo ocurre con las cestas.

Presque tous les produits ASIA+ sont munis d'un système d'anneaux et de rayons, ce qui permet de les combiner entre eux de façon stable. Ainsi, tous les bols et saladiers servent aussi de rehausseurs pour les produits ASIA+ les plus divers. Il en va de même des corbeilles.



Tablett tray

Schale bowl



15523 / 15525
Tablett / tray

15524 / 15526
Zwischenplatte



Tablett „ASIA PLUS“

tray
bandeja
plateau



	Ø cm	↑ cm	Farbe / Colour
15530	30,0	3	
15531	38,0	3	
15532	48,5	3	
15533	30,0	3	
15534	38,0	3	
15535	48,5	3	



Tablett / Platte „ASIA PLUS“

tray
bandeja
plateau



	Ø cm	↑ cm	
15523	38,0	2,5	einfach gefälzt / single seamed pliegue sencillo / plié une seule fois
15525	48,5	2,5	einfach gefälzt / single seamed pliegue sencillo / plié une seule fois



Zwischenplatte „ASIA PLUS“

intermediate plate
bandeja intermedia
plateau intermédiaire



	Ø cm	↑ cm	
15524	38,0	2,5	doppelt gefälzt / double seamed pliegue doble / plié en double
15526	48,5	2,5	doppelt gefälzt / double seamed pliegue doble / plié en double

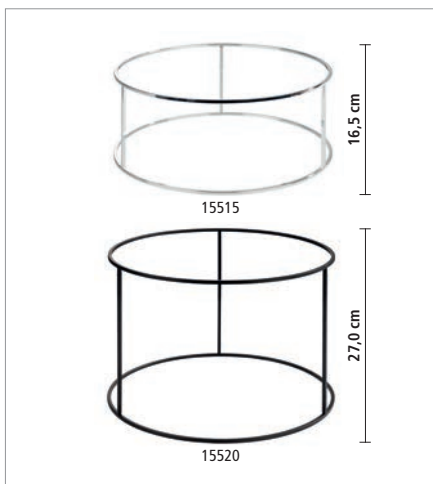

Buffetständer „ASIA PLUS“

buffet stand
soporte para buffet
présentoir buffet



	Ø cm	↑ cm	Farbe / Colour
15515	38,0	16,5	
15516	38,0	27,0	
15517	48,5	16,5	
15518	48,5	27,0	
15519	38,0	16,5	
15520	38,0	27,0	
15521	48,5	16,5	
15522	48,5	27,0	

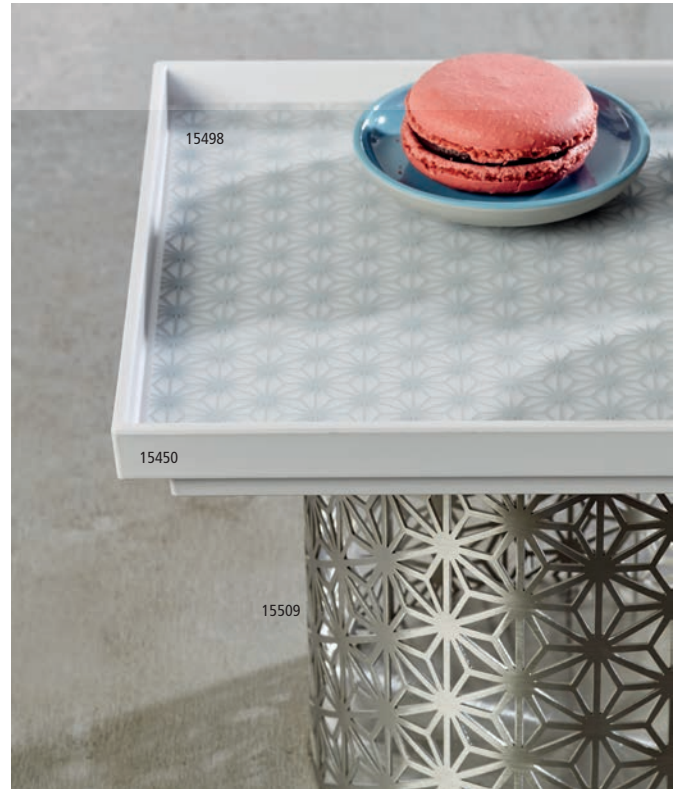

GN Tablett „ASIA PLUS“

GN tray
GN bandeja
GN plateau



	cm	↑ cm	GN	Farbe / Colour
15449	53,0 x 32,5	3	1/1	White
15450	32,5 x 26,5	3	1/2	White
15451	32,5 x 17,6	3	1/3	White
15452	26,5 x 16,2	3	1/4	White
15453	35,4 x 32,5	3	2/3	White
15454	53,0 x 16,2	3	2/4	White
15455	53,0 x 32,5	3	1/1	Black/Red
15456	32,5 x 26,5	3	1/2	Black/Red
15457	32,5 x 17,6	3	1/3	Black/Red
15458	26,5 x 16,2	3	1/4	Black/Red
15459	35,4 x 32,5	3	2/3	Black/Red
15460	53,0 x 16,2	3	2/4	Black/Red



Antirutschmatte „ASIA PLUS“

non slip mat
esterilla antideslizante
tapis antidérapant



	cm	fits to
15497	51 x 31,0	15449, 15455
15499	31 x 25,5	15450, 15456



Antirutschmatte „ASIA PLUS“

non slip mat
esterilla antideslizante
tapis antidérapant



	cm	fits to
15498	51 x 31,0	15449, 15455
15500	31 x 25,5	15450, 15456

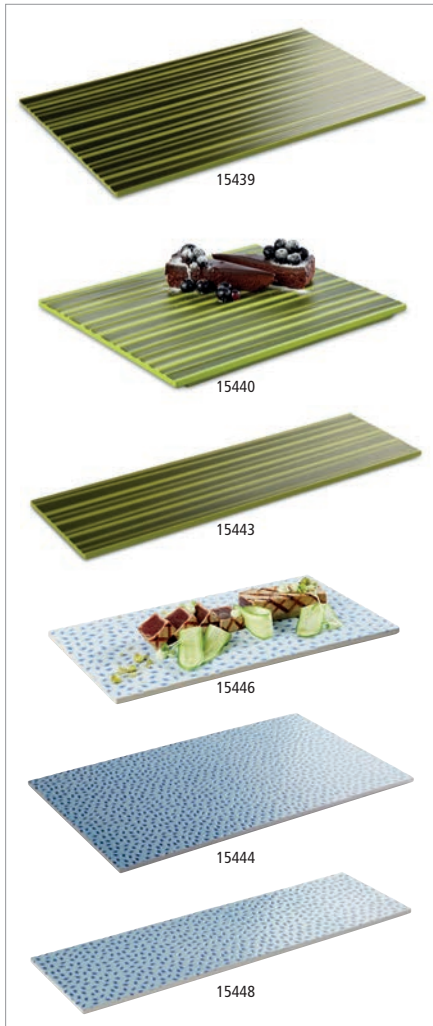

GN Tablett „ASIA PLUS“

GN tray
GN bandeja
GN plateau



	cm	↑ cm	GN	Farbe / Colour
15439	53,0 x 32,5	1,5	1/1	
15440	32,5 x 26,5	1,5	1/2	
15441	32,5 x 17,6	1,5	1/3	
15442	26,5 x 16,2	1,5	1/4	
15443	53,0 x 16,2	1,5	2/4	
15444	53,0 x 32,5	1,5	1/1	
15445	32,5 x 26,5	1,5	1/2	
15446	32,5 x 17,6	1,5	1/3	
15447	26,5 x 16,2	1,5	1/4	
15448	53,0 x 16,2	1,5	2/4	

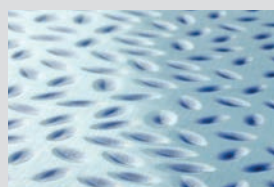
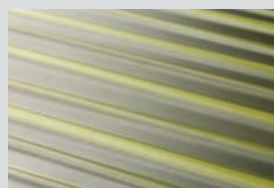

GN 1/1	GN 1/2	GN 1/4	GN 2/4
	GN 1/2	GN 1/4	
GN 1/3	GN 1/3	GN 1/3	



Schale „ASIA PLUS“

bowl
cuenco
bol



	Ø cm	↑ cm	ltr.	Farbe / Colour
15400	7,5	3,5	0,06	■ ■
15401	9,5	4,5	0,13	■ ■
15402	13,0	5,5	0,35	■ ■
15403	16,0	7,0	0,60	■ ■
15404	20,0	8,0	1,10	■ ■
15405	24,0	9,5	2,20	■ ■
15406	26,5	11,0	3,00	■ ■
15407	32,5	12,5	5,40	■ ■
15408	7,5	3,5	0,06	■ ■
15409	9,5	4,5	0,13	■ ■
15410	13,0	5,5	0,35	■ ■
15411	16,0	7,0	0,60	■ ■
15412	20,0	8,0	1,10	■ ■
15413	24,0	9,5	2,20	■ ■
15414	26,5	11,0	3,00	■ ■
15415	32,5	12,5	5,40	■ ■
15416	7,5	3,5	0,06	■ ■
15417	9,5	4,5	0,13	■ ■
15418	13,0	5,5	0,35	■ ■
15419	16,0	7,0	0,60	■ ■
15420	20,0	8,0	1,10	■ ■
15421	24,0	9,5	2,20	■ ■
15422	26,5	11,0	3,00	■ ■
15423	32,5	12,5	5,40	■ ■



Deckel „UNIVERSAL“ mit Löffelaussparung

cover with notched for spoons
tapa con espacio para la cuchara
couvercle avec encoche pour la louche



	Ø cm	↑ cm	fits to
15340	16,0	1,5	15403, 15411, 15419
15341	20,0	1,5	15404, 15412, 15420
15342	24,0	1,5	15405, 15413, 15421
15343	26,5	1,5	15406, 15414, 15422
15344	32,5	1,5	15407, 15415, 15423

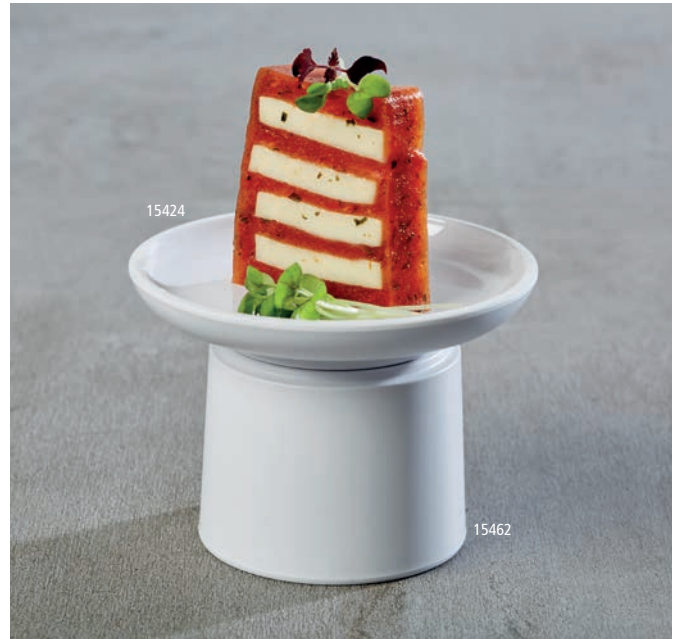

Teller „ASIA PLUS“
plate
plato
assiette



	Ø cm	↑ cm	Farbe / Colour
15424	11,0	2	
15425	16,0	2	
15426	19,5	2	
15427	24,0	2	
15428	28,0	2	

	Ø cm	↑ cm	Farbe / Colour
15429	11,0	2	
15430	16,0	2	
15431	19,5	2	
15432	24,0	2	
15433	28,0	2	

	Ø cm	↑ cm	Farbe / Colour
15434	11,0	2	
15435	16,0	2	
15436	19,5	2	
15437	24,0	2	
15438	28,0	2	







Bento Box „ASIA PLUS“



	Ø cm	↑ cm	ltr.	Farbe / Colour
15461	7,5	3,0	0,04	White
15462	7,5	6,5	0,13	White



	Ø cm	↑ cm	ltr.	Farbe / Colour
15467	7,5	3,0	0,04	Black/Red
15468	7,5	6,5	0,13	Black/Red



	cm	↑ cm	ltr.	Farbe / Colour
15473	7,5 x 7,5	3,0	0,05	White
15474	7,5 x 7,5	6,5	0,16	White
15479	15,5 x 15,5	3,0	0,19	White
15480	15,5 x 15,5	6,5	0,85	White



	cm	↑ cm	ltr.	Farbe / Colour
15485	7,5 x 7,5	3,0	0,05	Black/Red
15486	7,5 x 7,5	6,5	0,16	Black/Red
15491	15,5 x 15,5	3,0	0,19	Black/Red
15492	15,5 x 15,5	6,5	0,85	Black/Red



	cm	↑ cm	ltr.	Farbe / Colour
15475	15,5 x 7,5	3,0	0,10	White
15477	15,5 x 9,5	3,0	0,15	White
15476	15,5 x 7,5	6,5	0,40	White
15478	15,5 x 9,5	6,5	0,50	White
15483	25,0 x 15,5	3,0	0,30	White
15484	25,0 x 15,5	6,5	1,40	White



	cm	↑ cm	ltr.	Farbe / Colour
15487	15,5 x 7,5	3,0	0,10	Black/Red
15488	15,5 x 7,5	6,5	0,40	Black/Red
15489	15,5 x 9,5	3,0	0,15	Black/Red
15490	15,5 x 9,5	6,5	0,50	Black/Red
15495	25,0 x 15,5	3,0	0,30	Black/Red
15496	25,0 x 15,5	6,5	1,40	Black/Red



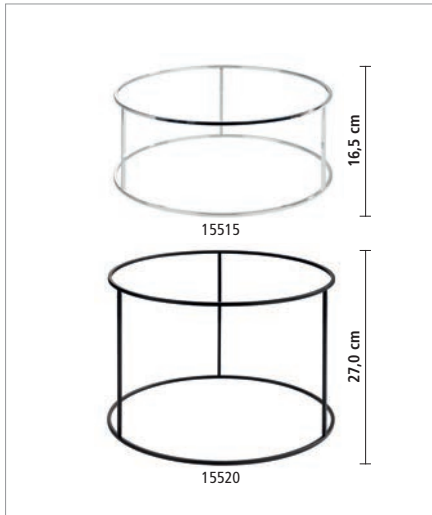

Buffetständer „ASIA PLUS“

buffet stand
soporte para buffet
présentoir buffet



	Ø cm	↑ cm	Farbe / Colour
15515	38,0	16,5	Grey
15516	38,0	27,0	Grey
15517	48,5	16,5	Grey
15518	48,5	27,0	Grey
15519	38,0	16,5	Black
15520	38,0	27,0	Black
15521	48,5	16,5	Black
15522	48,5	27,0	Black



GN Buffetständer „ASIA PLUS“

GN buffet stand
GN soporte para buffet
GN présentoir buffet



	cm	GN	Farbe / Colour
15501	53,0 x 32,5 / 53,0 x 16,2	1/1 / 2/4	Grey
15502	32,5 x 26,5 / 26,5 x 16,2	1/2 / 1/4	Grey
15503	32,5 x 17,5 / 35,4 x 32,5	1/3 / 2/3	Grey
15504	53,0 x 32,5 / 53,0 x 16,2	1/1 / 2/4	Black
15505	32,5 x 26,5 / 26,5 x 16,2	1/2 / 1/4	Black
15506	32,5 x 17,5 / 35,4 x 32,5	1/3 / 2/3	Black

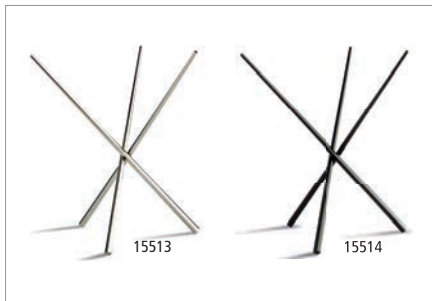

Buffetständer „ASIA PLUS“

buffet stand
soporte para buffet
présentoir buffet



	Ø cm	↑ cm	Farbe / Colour
15513	20,5 / 16,5	20	stainless steel
15514	20,5 / 16,5	20	Black



Buffetständer / -korb „ASIA PLUS“

buffet stand / basket
soporte para buffet / cestas
présentoir buffet / corbeilles



	Ø cm	↑ cm	Farbe / Colour
15507	15	10,5	Grey
15510	15	10,5	Black
	Ø cm	↑ cm	Farbe / Colour
15508	21	10,5	Grey
15511	21	10,5	Black
	Ø cm	↑ cm	Farbe / Colour
15509	21	20	Grey
15512	21	20	Black

NEW ACACIA

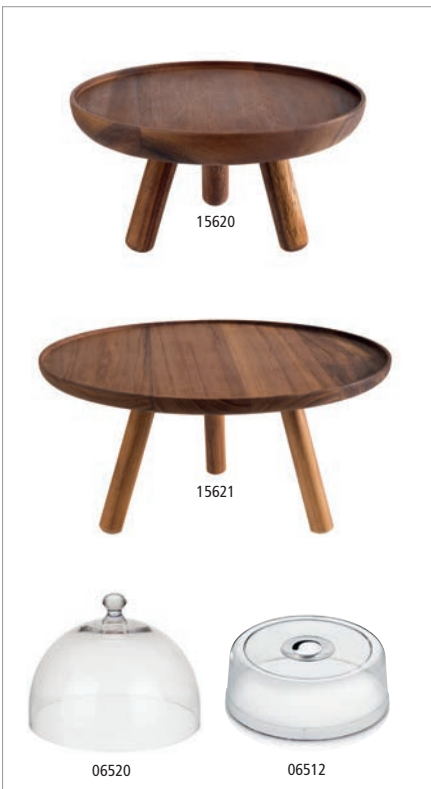

Buffetständer „ACACIA“

buffet stand
soporte para buffet
présentoir buffet



Akazienholz geölt / acacia wood oiled / mader de acacia aceitada / bois d'acacia huilé

	Ø cm	↑ cm
15620	20,0	10,5
15621	30,5	15,0
15622	30,5	20,0

Frischhalte- Haube / cover / campana / cloche



	Ø cm	↑ cm	fits to
06520	30	22	15621, 15622

Frischhalte- Haube / cover / campana / cloche



	Ø cm	↑ cm	fits to
06512	30	11,5	15621, 15622

Buffetständer „ACACIA“

buffet stand
soporte para buffet
présentoir buffet



Akazienholz geölt / acacia wood oiled / mader de acacia aceitada / bois d'acacia huilé

	cm	↑ cm	GN
15623	53 x 16,2	20	2/4

GN Abdeckhaube / GN cover / GN cubierta/ GN cloche



	cm	↑ cm	✱ mm	GN
11044	53 x 16,2	10,5	3	2/4



POKE BOWL - *super trendy*



Buffet & Tableware Melamin

Die Farben und Formen von Lebensmittel und die Art, wie sie in den BOWLS angerichtet werden, regen unsere Sinne und unseren Appetit an. Das ist auch schon das Geheimnis der Bowl - Gerichte, die zurzeit in großer Vielfalt, mit viel Fantasie und Liebe zum Detail zubereitet werden.

The colours and shapes of food and the way they are arranged in the BOWLS stimulate our senses and our appetite. This is the secret of the bowl dishes, which are currently prepared in great variety, with a lot of imagination and attention to detail.

Los colores y las formas de los alimentos y la manera de presentación en los CUENCOS estimulan nuestros sentidos y nuestro apetito. Ese es el secreto de los platos en cuenco, que actualmente se preparan en gran variedad, con mucha imaginación y atención a los detalles.

Les couleurs et les formes des aliments et la façon dont ils sont disposés dans les BOLS stimulent nos sens et notre appétit. C'est aussi le secret des plats du bol, qui sont actuellement préparés dans une grande variété, avec beaucoup d'imagination et d'attention au détail.



Schale „POKE BOWL“
bowl
cuenco
bol

MELAMINE MF icons

	Ø cm	↑ cm	ltr.	Farbe / Colour
85003	20	7	0,9	white
85005	20	7	0,9	coconut



Schale „POKE BOWL“
bowl
cuenco
bol

MELAMINE MF icons

	Ø cm	↑ cm	ltr.	Farbe / Colour
85000	16	9	1,1	white
85002	16	9	1,1	coconut



Schale „POKE BOWL“
bowl
cuenco
bol

MELAMINE MF icons

	Ø cm	↑ cm	ltr.	Farbe / Colour
85006	20	9	1,6	white
85008	20	9	1,6	coconut

BLUE OCEAN



Da geht die Sonne auf!
Maritime Aquatöne,
Farbverläufe und klassisches
Blau-Weiß erinnert an eine
griechische Taverne in der
Ägäis.

The sun is rising!
Maritime aqua tones,
gradients and classic blue
and white reminiscent of
a Greek tavern in the
Aegean Sea.

¡Está saliendo el sol! Los tonos marinos, los degradados de color, el clásico azul y blanco recuerdan a una taberna griega en el mar Egeo.

Le soleil se lève! Les tons maritimes, les dégradés de couleurs, le bleu et le blanc classiques, tout rappellent une taverne grecque de la mer Égée.

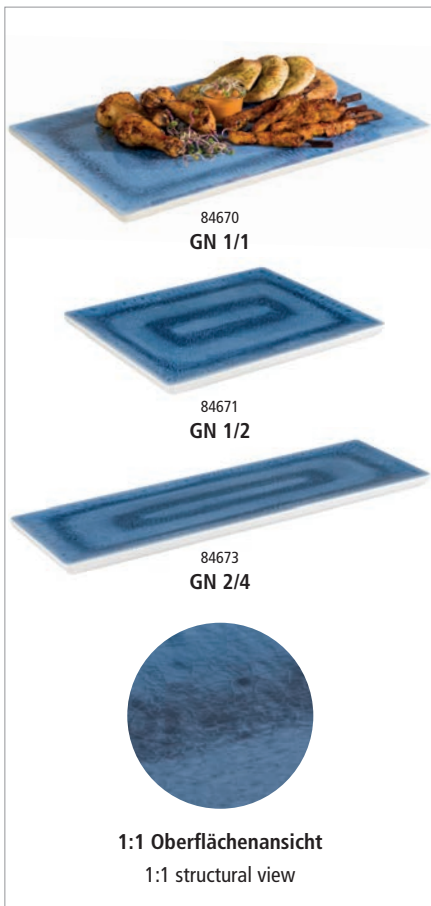

GN Tablett „BLUE OCEAN“

GN tray
GN bandeja
GN plateau



	cm	↑ cm	GN
84670	53,0 x 32,5	2	1/1
84671	32,5 x 26,5	2	1/2
84672	32,5 x 17,6	2	1/3
84673	53,0 x 16,2	2	2/4

GN 1/1	GN 1/2	GN 2/4	GN 1/3
	GN 1/2		GN 1/3
			GN 1/3

NEW

mit Antirutsch-
füßchen
with non-slip feet





Tablett „BLUE OCEAN“

tray
bandeja
plateau



	cm	↑ cm
84676	48 x 35,5	3

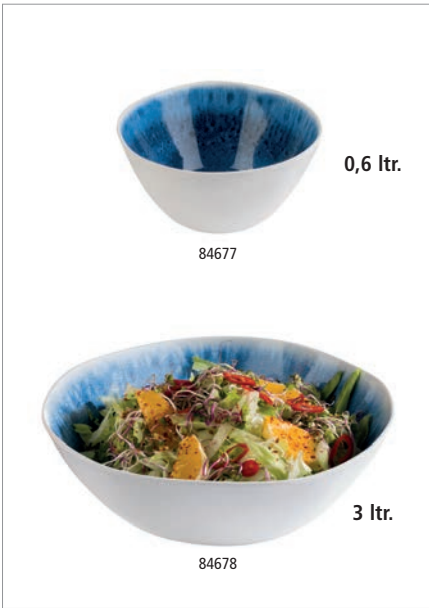

Schale „BLUE OCEAN“

bowl
cuenco
bol



	Ø cm	↑ cm	ltr.
84677	15	7,5	0,6

	Ø cm	↑ cm	ltr.
84678	30,5	9	3



Teller „BLUE OCEAN“

plate
plato
assiette



	Ø cm	↑ cm
84674	21,5	2
84675	26,5	2

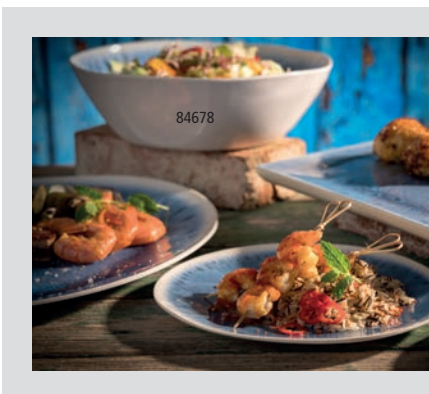

ARABESQUE



Beim Anblick der mediterranen Melamin Serie ARABESQUE bekommt man direkt Lust auf eine Tapas-Party. Mit seinem spanischen Charme und den wundervoll ausgearbeiteten Details holen Sie sich ein Stück Spanien auf Ihr Buffet.

When looking at the Mediterranean melamine series ARABESQUE, the longing for a tapas party resurfaces. With its Spanish charm and the beautifully crafted details, you get a slice of Spain on your buffet.

Al ver la serie mediterránea de melamina ARABESQUE, se obtiene un dicho antojo por una fiesta de tapas. Con su encanto español y los detalles bellamente elaborados, obtenga una rebanada de España en su buffet.

En regardant la série de mélamine méditerranéenne ARABESQUE, vous obtenez envie de préparer une fête de tapas. Avec son charme espagnol et les détails joliment ouvres, vous aurez une tranche d'Espagne sur votre buffet.



GN Tablett „ARABESQUE“

GN tray
GN bandeja
GN plateau



	cm	↑ cm	GN
84680	53,0 x 32,5	2	1/1
84681	32,5 x 26,5	2	1/2
84682	32,5 x 17,6	2	1/3
84683	53,0 x 16,2	2	2/4

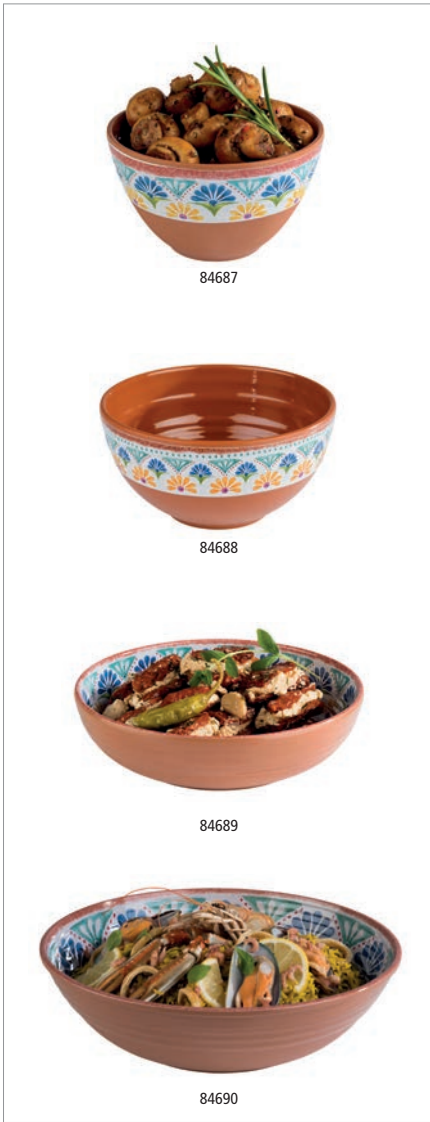

Schale „ARABESQUE“

bowl
cuenco
bol



	Ø cm	↑ cm	litr.
84687	10,0	6,0	0,2
84688	15,5	8,0	0,8
.....			
	Ø cm	↑ cm	litr.
84689	20,5	5,5	1,1
84690	31,0	9,0	3,0



1:1 Oberflächenansicht
1:1 structural view



Teller „ARABESQUE“

plate
plato
assiette



	cm	↑ cm
84686	38 x 15,5	2



Teller „ARABESQUE“

plate
plato
assiette



	Ø cm	↑ cm
84684	21,5	2
84685	26,5	2



Teller „BAMBOO“
plate
plato
assiette



	cm	↑ cm
84809	24 x 17	3,5



Schale „BAMBOO“
bowl
cuenco
bol



	cm	↑ cm	ltr.
84815	10,5 x 10,0	3,0	0,03
84816	17,5 x 15,5	5,5	0,2



Schale „BAMBOO“
bowl
cuenco
bol



	Ø cm	↑ cm	ltr.
84819	30,5	8,5	2



Schale „BAMBOO“
bowl
cuenco
bol



	cm	↑ cm	ltr.
84817	18,0 x 17,5	5,5	0,3
84818	23,0 x 22,0	7,0	0,7



Tablett „BAMBOO“

tray
bandeja
plateau



	cm	↑ cm
84803	10,0 x 10,0	2,0
84804	14,5 x 14,5	2,5
84805	31,0 x 10,5	2,0
84806	21,0 x 13,0	3,0
84807	24,5 x 15,5	3,0
84808	34,5 x 21,5	3,0



GN Tablett „BAMBOO“

tray
bandeja
plateau



	cm	↑ cm	GN
84800	53,0 x 32,5	2	1 / 1
84801	32,5 x 26,5	2	1/2
84802	32,5 x 17,6	2	1/3



Tablett „BAMBOO“

tray
bandeja
plateau



	cm	↑ cm
84811	24,5 x 15	3,5
84812	32,5 x 19	4,5



Tablett „BAMBOO“

tray
bandeja
plateau



	cm	↑ cm
84813	40 x 25,5	3,0
84814	53 x 34,0	3,5



Tablett „BAMBOO“

tray
bandeja
plateau



	cm	↑ cm
84810	34 x 13	3



NEW **LOOPS**

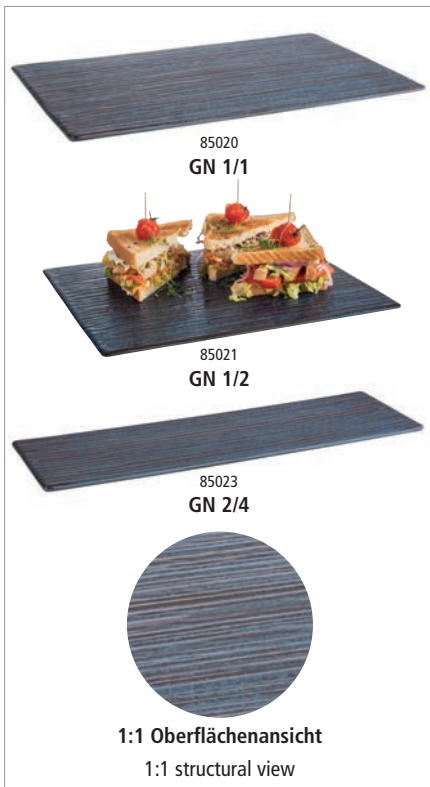

GN Tablett „LOOPS“

GN tray
GN bandeja
GN plateau



	cm	↑ cm	GN	Farbe / Colour
85020	53,0 x 32,5	1,5	1/1	
85021	32,5 x 26,5	1,5	1/2	
85022	32,5 x 17,6	1,5	1/3	
85023	53,0 x 16,2	1,5	2/4	



Tablett/Sushi board „LOOPS“

tray
bandeja
plateau



	cm	↑ cm
85025	23,5 x 13,5	1,5



Teller „LOOPS“

plate
plato
assiette



	Ø cm	↑ cm
85027	22	2
85028	27	2



Schale „LOOPS“

bowl
cuenco
bol



	cm	↑ cm
85024	34 x 15,5	4



Schale „LOOPS“

bowl
cuenco
bol



	Ø cm	↑ cm
85026	18	3



Schale „LOOPS“

bowl
cuenco
bol



	Ø cm	↑ cm	ltr.
85029	20,5	6,5	0,8
85030	31,0	8,0	2,0



Tablett „LOOPS“

tray
bandeja
plateau



	Ø cm	↑ cm
85031	32,0	3,5
85032	40,5	5,0



Torten- / Konditorplatte „LOOPS“

cake stand
soporte para pastel
présentoir à gâteaux



	Ø cm	↑ cm	passende Haube / suitable cover / campana adecuada / cloche appropriée
85033	21,5	2,5	06519 <small>NEW</small>
85034	30,5	3,5	06520, 06512, 06510
85035	37,5	4,0	06521 <small>NEW</small>



3 sizes available

HANOI



Die ansteigenden Schalenformen erzeugen eine asiatische Markt Optik und verleihen Ihrem Buffet durch die gewobene Oberflächenstruktur eine natürliche Authentizität.

The rising bowl forms create an Asian market look and give your buffet a natural authenticity through the woven surface structure.

La forma creciente de los cuencos crea un look de un mercado asiático y le dá a su buffet una autenticidad natural gracias a la estructura de la superficie tejida.

La forme croissante de bols crée un aspect visuel d'une marché asiatique et donne à votre buffet une authenticité naturelle à travers la structure de surface tissée.



Schale / Teller „HANOI“

bowl / plate
cuenco / plato
bol / assiette



	∅ cm	↑ cm
84725	25,5	3,0 / 6,5
84726	30,0	3,5 / 7,5
84727	35,5	4,0 / 9,0





AQUARIS

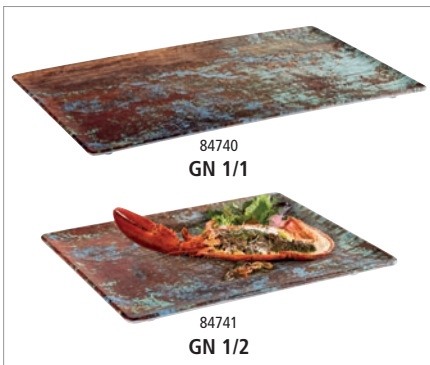

GN Tablett „AQUARIS“

GN tray
GN bandeja
GN plateau



	cm	↑ cm	GN	Farbe / Colour
84740	53,0 x 32,5	2	1/1	
84741	32,5 x 26,5	2	1/2	
84742	32,5 x 17,6	2	1/3	
84743	53,0 x 16,2	2	2/4	

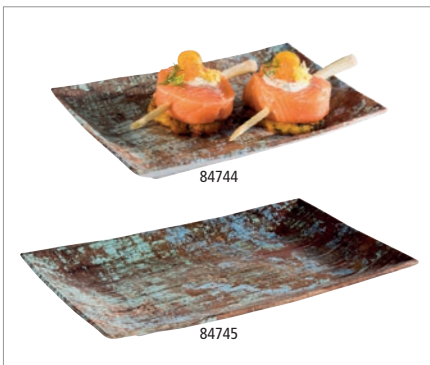

Tablett „AQUARIS“

tray
bandeja
plateau



	cm	↑ cm	Farbe / Colour
84744	21,0 x 13	3	
84745	34,5 x 22	3	

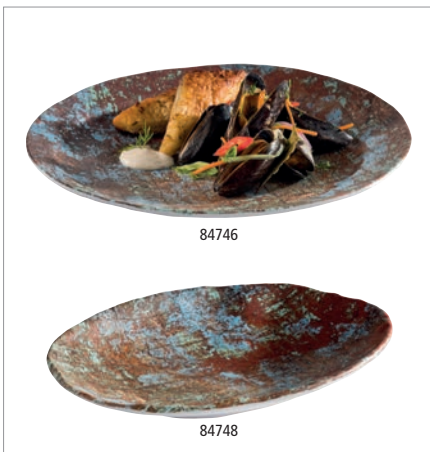

Teller „AQUARIS“

plate
plato
assiette



	Ø cm	↑ cm	Farbe / Colour
84746	26	3,5	
84747	35	3,0	

	cm	↑ cm	Farbe / Colour
84748	24,0 x 17	3,5	
84749	40,5 x 30	4,0	



Schale „COCONUT“

bowl
cuenco
bol



	∅ cm	↑ cm	ltr.	Farbe / Colour
84990	14	6,5	0,5	white/coconut
84991	24	9,5	2,2	white/coconut



1:1 Oberflächenansicht
1:1 structural view



Schale „ELEMENT LOOK“

bowl
cuenco
bol



	∅ cm	↑ cm	ltr.
84835	21,5	5,5 / 9,5	0,7
84836	26,0	7,0 / 12,5	1,45
84837	30,0	8,5 / 14,5	2,3



1,45 ltr.

84836



mit Antirutschfüßchen
with non-slip feet
con pies antideslizantes
avec pieds antidérapants



GN Tablett „IRON“
GN tray
GN bandeja
GN plateau

	cm	↑ cm	GN
84884	32,5 x 26,5	2	1/2
84885	26,5 x 16,2	2	1/4
84886	53,0 x 16,2	2	2/4



Schale „IRON“
GN bowl
GN cuenco
GN bol

	cm	↑ cm	GN	litr.
84880	32,5 x 26,5	8,5	1/2	3,5
84881	26,5 x 16,2	8,5	1/4	1,4
84882	53,0 x 16,2	8,5	2/4	3,2
84883	25,0 x 25,0	10,0	-	2,8





Teller „STONE ART“
plate
plato
assiette



	Ø cm	↑ cm
84510	19	2
84511	25	2
84512	30	2



Teller „STONE ART“
plate
plato
assiette



	Ø cm	↑ cm	litr.
84509	15,5	2,5	0,15
84514	20,0	4,5	0,60



Teller „STONE ART“
plate
plato
assiette



	Ø cm	↑ cm
84515	24,5	3,5



Teller „STONE ART“
plate
plato
assiette



	cm	↑ cm
84517	33 x 32,5	3



Schale „STONE ART“

bowl
cuenco
bol



	Ø cm	↑ cm	ltr.
84523	8	3	0,07



Schale „STONE ART“

bowl
cuenco
bol



	Ø cm	↑ cm	ltr.
84524	12	6	0,3



Schale „STONE ART“

bowl
cuenco
bol



	Ø cm	↑ cm	ltr.
84525	15	7,5	0,6



Schale „STONE ART“

bowl
cuenco
bol



	cm	↑ cm	ltr.
84526	23 x 19	6,5	0,6



Schale „STONE ART“

bowl
cuenco
bol



	cm	↑ cm	ltr.
84528	28,5 x 21	7,5	1,2



84529

Schale „STONE ART“

bowl
cuenco
bol



	cm	↑ cm	ltr.
84529	19 x 19	6,0	0,5
84530	24 x 24	6,5	1,1

Buffet & Tableware Melamin



GN Tablett „STONE ART“

GN tray
GN bandeja
GN plateau



	cm	↑ cm	GN
84519	53,0 x 32,5	1,5	1/1
84520	32,5 x 26,5	1,5	1/2
84522	53,0 x 16,2	1,5	2/4
84521	32,5 x 17,6	1,5	1/3



mit Antirutschfüßchen
with non-slip feet
con pies antideslizantes
avec pieds antidérapants



GN Abdeckhaube

GN cover
GN cubierta
GN cloche



passend für GN Tablett, glasklarer Kunststoff, nahezu unzerbrechlich
suitable for GN trays, clear plastic, nearly unbreakable
apto para bandejas GN, plástico transparente, muy resistente a la rotura
pour bacs et plateaux GN, plastique transparent, très résistant à la casse

	cm	↑ cm	✂ mm	GN
11043	32,5 x 17,6	10,5	3	1/3
11044	53,0 x 16,2	10,5	3	2/4

	cm	↑ cm	✂ mm	GN
11041	32,5 x 26,5	9,5	3	1/2
11042	53,0 x 32,5	9,5	3	1/1

AIKO



Schale „AIKO“

bowl
cuenco
bol



Steinoptik

appearance stoneware
su aspecto recuerda al gres
l'aspect de la mélamine rapelle le grès

	cm	↑ cm	ltr.	Farbe / Colour
84327	26,5 x 19,5	6	0,9	■



84331

Schale „AIKO“

bowl
cuenco
bol



Steinoptik

appearance stoneware
su aspecto recuerda al gres
l'aspect de la mélamine rapelle le grès

	Ø cm	↑ cm	ltr.	Farbe / Colour
84329	8,0	4	0,07	■
84331	11,5	6	0,20	■



84334

84337

Schale „AIKO“

bowl
cuenco
bol



Steinoptik

appearance stoneware
su aspecto recuerda al gres
l'aspect de la mélamine rapelle le grès

	Ø cm	↑ cm	ltr.	Farbe / Colour
84334	16,0	7	0,6	■
84336	20,5	8	1,2	■
	Ø cm	↑ cm	ltr.	Farbe / Colour
84335	16,0	7	0,6	■
84337	20,5	8	1,2	■



Betonoberflächen auf dem Buffet für den Kontakt mit Lebensmitteln? ELEMENT macht es möglich. Bestens geeignet im modernen und urbanen Ausstattungsumfeld.

Concrete surfaces on the buffet for food contact? ELEMENT makes it possible. Ideally suited for modern and urban environments.

¿Superficies de hormigón en el buffet y tener contacto con alimentos? ELEMENT lo hace posible. Ideal para ambientes modernos y urbanos.

Des surfaces en béton sur le buffet et destinées au contact alimentaire? ELEMENT le rend possible. Idéal pour les environnements modernes et urbains.



Schale „ELEMENT“

bowl
cuenco
bol



	cm	↑ cm	ltr.
84825	∅ 8,0	2,0	0,01
84826	10,5 x 10,0	3,0	0,02
84820	9,0 x 7,0	3,0	0,03
84821	10,5 x 10,5	3,0	0,04
84827	17,5 x 15,5	5,5	0,18



Tablett „ELEMENT“

tray
bandeja
plateau



	cm	↑ cm
84822	20 x 9,5	2,5



Tablett „ELEMENT“

tray
bandeja
plateau



	cm	↑ cm
84824	31 x 10,5	1,5



Tablett „ELEMENT“

tray
bandeja
plateau



	cm	↑ cm
84823	22,5 x 15	3



Schale „ELEMENT“

bowl
cuenco
bol



	Ø cm	↑ cm	ltr.
84828	16	7	0,5
84829	28	12	3,0



Schale „ELEMENT“

bowl
cuenco
bol



	cm	↑ cm	ltr.
84830	19 x 19	9	1,5
84831	25 x 25	12	3,8



GN Tablett „ELEMENT“

GN tray
GN bandeja
GN plateau



	cm	↑ cm	GN
84400	53,0 x 32,5	3,5	1/1
84401	32,5 x 26,5	3,5	1/2
84402	32,5 x 17,5	3,5	1/3
84403	26,5 x 16,2	3,5	1/4
84404	53,0 x 16,2	3,5	2/4

CROCKER



Servier- und Buffetartikel in Tonoptik, brauner Rand. Die Oberfläche ist innen und außen fein-matt, fühlt sich an wie Ton.

Serving and buffet items, an imitation of clay, with a brown border. The surface is inside and outside fine-matt. Feels like real clay.

Artículos de servicio y buffet, imitación barro y con borde marrón. La superficie de dentro y de fuera es de deslustre fino. Parece barro natural.

Pièces de service et pour le buffet imitation argile avec bord marron. La surface est à l'intérieur et à l'extérieur bien-matte.



Teller „CROCKER“

plate
plato
assiette



	cm	↑ cm	Farbe / Colour
84567	14 x 13	2,5	
84568	14 x 13	2,5	



Teller „CROCKER“

plate
plato
assiette



	Ø cm	↑ cm	ltr.	Farbe / Colour
84575	20,5	3	0,50	
84576	20,5	3	0,50	



Schale „CROCKER“

bowl
cuenco
bol



	Ø cm	↑ cm	ltr.	Farbe / Colour
84573	16,5	4	0,50	
84574	16,5	4	0,50	



84569
Ø 12,5 cm

84572
Ø 16,0 cm

84577
Ø 21,0 cm

Schale „CROCKER“

bowl
cuenco
bol



	Ø cm	↑ cm	ltr.	Farbe / Colour
84569	12,5	6	0,37	
84570	12,5	6	0,37	
84571	16,0	7	0,70	
84572	16,0	7	0,70	
84577	21,0	8	1,45	
84578	21,0	8	1,45	



84579

84581

Blattschale „CROCKER“

leaf
fuente en forma de hoja
plateau feuille



	cm	↑ cm	ltr.	Farbe / Colour
84579	30,5 x 10	7,5	0,17	
84580	30,5 x 10	7,5	0,17	
84581	42 x 14	9,5	0,65	
84582	42 x 14	9,5	0,65	

NEW FRIDA

FRIDA'S BREAKFAST



NEW FRIDA

FRIDA'S HEALTHY BUFFET

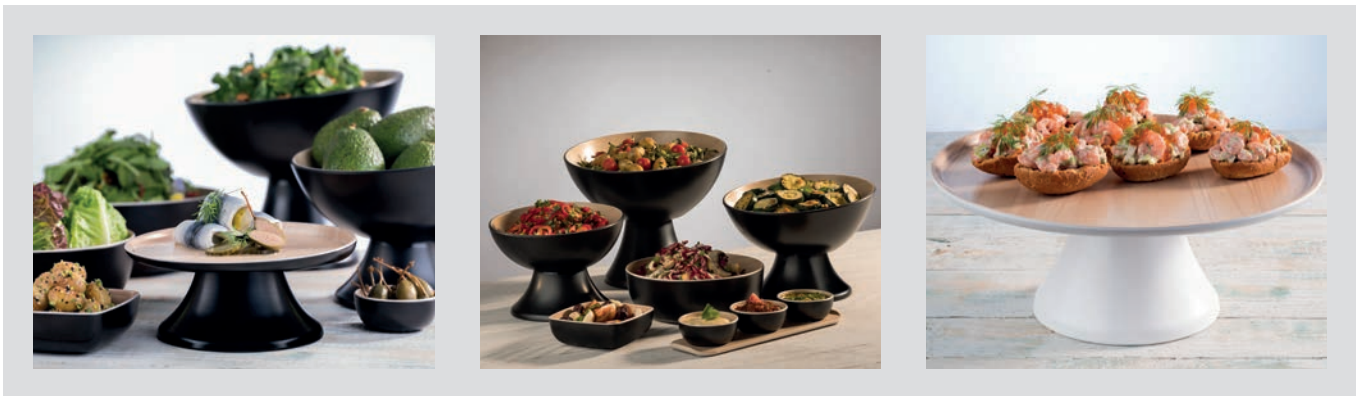

Buffet & Tableware Melamin



Schale „FRIDA LOCK“

bowl
cuenco
bol



Schalen lassen sich durch Drehmechanismus mit dem Ständer fest verbinden

bowls can be firmly connected to the stand by a turning mechanism

los cuencos se pueden conectar firmemente al soporte mediante un mecanismo giratorio

les bols peuvent être solidement reliés au présentoir au moyen d'un mécanisme rotatif

	Ø cm	↑ cm	ltr.	Farbe / Colour
84920	21,5	7/8,5	1,0	
84921	21,5	7/8,5	1,0	
84922	25,0	8/11	1,6	
84923	25,0	8/11	1,6	
84924	28,5	10/14	2,6	
84925	28,5	10/14	2,6	



Haube

cover
campana
cloche



	Ø cm	↑ cm	fits to
06519 NEW	21	17	84941, 84942
06520	30	22	84943, 84944
06521 NEW	36	27	84945, 84946

NEW



84941 Ø 22,5 cm



84944 Ø 31,5 cm



84945 Ø 38,0 cm

Tablett / Platte „FRIDA LOCK“

tray
bandeja
plateau



Tabletts lassen sich durch Drehmechanismus mit dem Ständer fest verbinden
trays can be firmly connected to the stand by a turning mechanism
las bandejas se pueden conectar firmemente al soporte mediante un mecanismo giratorio
les plateaux peuvent être solidement reliés au présentoir au moyen d'un mécanisme rotatif

	Ø cm	↑ cm	Farbe / Colour
84941	22,5	1,5/2,5	
84942	22,5	1,5/2,5	
84943	31,5	1,5/2,5	
84944	31,5	1,5/2,5	
84945	38,0	1,5/2,5	
84946	38,0	1,5/2,5	



NEW



84926



84927

Ständer „FRIDA LOCK“

stand
soporte
présentoir



	Ø cm	↑ cm	Farbe / Colour
84926	16,5	8	
84927	16,5	8	



NEW



84928



84929

Ständer „FRIDA LOCK“

stand
soporte
présentoir



	Ø cm	↑ cm	Farbe / Colour
84928	16,5	12	
84929	16,5	12	



FRIDA



Auf der kurzen und der langen Seite aufstellbar!
 Can stay on the short or long side!
 Se puede colocar por la parte corta o larga!
 Se peut installer sur le côté court ou long!

GN Buffetständer
 GN buffet stand
 GN soporte para buffet
 GN présentoir buffet



	cm	GN	Farbe / Colour
15504	53,0 x 32,5 / 53,0 x 16,2	1/1 / 2/4	■
15505	32,5 x 26,5 / 26,5 x 16,2	1/2 / 1/4	■



84601
GN 1/1



84602
GN 1/2



84603
GN 1/4



84604
GN 2/4

GN Tablett „FRIDA“
 GN tray
 GN bandeja
 GN plateau



	cm	↑ cm	GN
84601	53,0 x 32,5	2	1/1
84602	32,5 x 26,5	2	1/2
84603	26,5 x 16,2	2	1/4
84604	53,0 x 16,2	2	2/4



mit Antirutschfüßchen
 with non-slip feet
 con pies antideslizantes
 avec pieds antidérapants

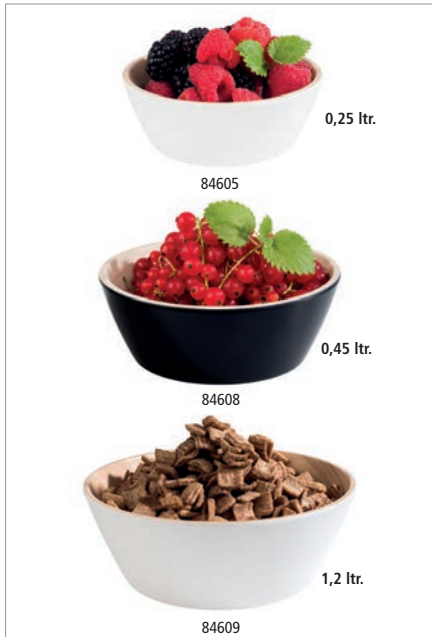

Schale „FRIDA“
bowl
cuenco
bol



	Ø cm	↑ cm	ltr.	Farbe / Colour
84605	12,5	4,5	0,25	White/Yellow
84606	12,5	4,5	0,25	Black/Yellow
84607	15,0	5,5	0,44	White/Yellow
84608	15,0	5,5	0,44	Black/Yellow
84609	20,0	7,5	1,20	White/Yellow
84610	20,0	7,5	1,20	Black/Yellow



Schale „FRIDA“
bowl
cuenco
bol



	Ø cm	↑ cm	ltr.	Farbe / Colour
84611	22,0	10,5	2,2	White/Yellow
84612	22,0	10,5	2,2	Black/Yellow
84613	26,5	10,5	3,4	White/Yellow
84614	26,5	10,5	3,4	Black/Yellow



mit Antirutschfüßchen
with non-slip feet
con pies antideslizantes
avec pieds antidérapants



Tablett „FRIDA“
tray
bandeja
plateau



	cm	↑ cm	Farbe / Colour
84650	21,5 x 10,0	2,0	White/Yellow
84651	21,5 x 10,0	2,0	Black/Yellow
84652	27,0 x 12,0	2,5	White/Yellow
84653	27,0 x 12,0	2,5	Black/Yellow
84654	36,0 x 16,5	3,0	White/Yellow
84655	36,0 x 16,5	3,0	Black/Yellow



Schale „FRIDA“
bowl
cuenco
bol



	cm	↑ cm	Farbe / Colour
84615	32 x 25	3,5	White/Yellow
84616	32 x 25	3,5	Black/Yellow



Schale „FRIDA“

bowl
cuenco
bol



	Ø cm	↑ cm	litr.	Farbe / Colour
84930	8,5	3,5	0,1	
84931	8,5	3,5	0,1	
84932	21,5	7,5	1,8	
84933	21,5	7,5	1,8	
84934	30,0	9,5	4,7	
84935	30,0	9,5	4,7	



Schale „FRIDA“

bowl
cuenco
bol



	cm	↑ cm	litr.	Farbe / Colour
84936	12,5 x 12,5	4,5	0,37	
84937	12,5 x 12,5	4,5	0,37	

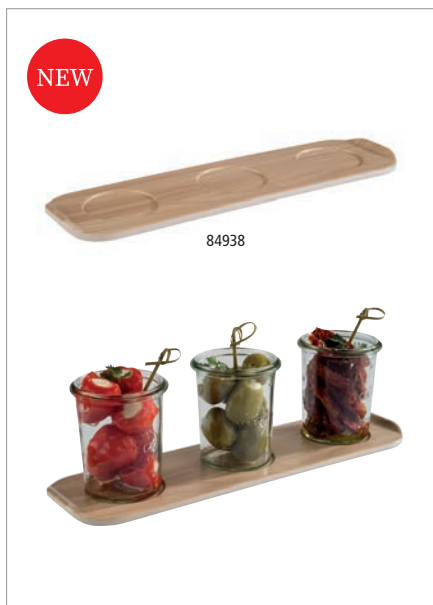

Tablett „FRIDA“

tray
bandeja
plateau



mit 3 Absätzen, Ø 5,4 cm
with 3 holes, Ø 5,4 cm
con 3 agujeros, Ø 5,4 cm
avec 3 trous, Ø 5,4 cm

	cm	↑ cm	Farbe / Colour
84938	30 x 8,5	1	

Anwendungsbeispiel mit Weck-Glas Nr. 82312
example of use with Weck-glasses no. 82312



Servierset „FRIDA“, 4-tlg.

serving set, 4 pcs. set
set de servicio, set de 4
set de service, set de 4



4-teiliges Set, bestehend aus 1 Tablett mit 3 Schalen

4 pcs set, consisting of 1 tray with 3 bowls
set de 4, compuesto por 1 bandeja con 3 cuencos
set de 4, composé d'un plateau avec 3 bols

	cm	↑ cm	Farbe / Colour
84939	30 x 8,5	4,5	
84940	30 x 8,5	4,5	



GN 1/9 Schale „FRIDA“

GN 1/9 bowl
GN 1/9 cuenco
GN 1/9 bol



	Ø cm	↑ cm	GN	ltr.	Farbe / Colour
84555	17,6 x 10,8	5,5	1/9	0,5	
84556	17,6 x 10,8	5,5	1/9	0,5	

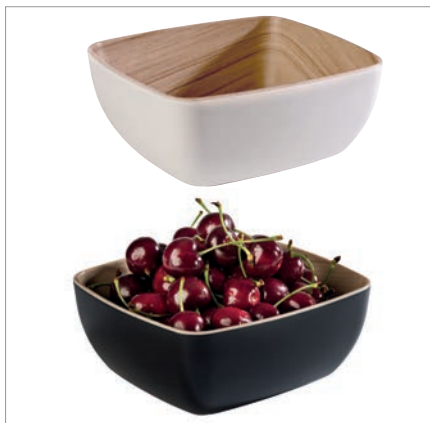

GN 1/6 Schale „FRIDA“

GN 1/6 bowl
GN 1/6 cuenco
GN 1/6 bol



	Ø cm	↑ cm	GN	ltr.	Farbe / Colour
84583	17,6 x 16,2	7,5	1/6	1,0	
84584	17,6 x 16,2	7,5	1/6	1,0	



GN 1/4 + 2/4 Schale „FRIDA“

GN 1/4 + 2/4 bowl
GN 1/4 + 2/4 cuenco
GN 1/4 + 2/4 bol



	Ø cm	↑ cm	GN	ltr.	Farbe / Colour
84586	26,5 x 16,2	7,5	1/4	1,8	
84587	26,5 x 16,2	7,5	1/4	1,8	
	Ø cm	↑ cm	GN	ltr.	Farbe / Colour
84564	53 x 16,2	7,5	2/4	3,65	
84565	53 x 16,2	7,5	2/4	3,65	



GN 1/2 Schale

GN 1/2 bowl
GN 1/2 cuenco
GN 1/2 bol



	Ø cm	↑ cm	GN	ltr.	Farbe / Colour
84589	32,5 x 26,5	7,5	1/2	4,0	
84590	32,5 x 26,5	7,5	1/2	4,0	

Buffet & Tableware Melamin



Schale „FRIDA“

bowl
cuenco
bol



	cm	↑ cm	ltr.	Farbe / Colour
84558	16,5 x 16,5	5,5	0,85	
84559	16,5 x 16,5	5,5	0,85	



Schale „FRIDA“

bowl
cuenco
bol



	cm	↑ cm	ltr.	Farbe / Colour
84561	25 x 25	7,5	2,65	
84562	25 x 25	7,5	2,65	



GN 1/4 Tablett „FRIDA“

GN 1/4 tray
GN 1/4 bandeja
GN 1/4 plateau



	cm	↑ cm	ltr.	Farbe / Colour
84595	26,5 x 16,2	3	1/4	
84596	26,5 x 16,2	3	1/4	



Tablett „FRIDA“

tray
bandeja
plateau



	cm	↑ cm	ltr.	Farbe / Colour
84598	35,5 x 26,0	3		
84599	35,5 x 26,0	3		



Schale „FRIDA“

bowl
cuenco
bol



	cm	↑ cm	ltr.	Farbe / Colour
84592	25 x 25	12	3,5	
84593	25 x 25	12	3,5	



Deckel „PURE“ mit Löffelaussparung / cover with notched for spoons / tapa con espacio para la cuchara / couvercle avec encoche pour la louche

	cm	↑ cm	fits to
83601	25 x 25	1,5	84561, 84562, 84592, 84593, 84594



Schale „FRIDA STONE“

bowl
cuenco
bol



	cm	↑ cm	ltr.	Farbe / Colour
84594	25 x 25	12	3,5	



84560

Schale „FRIDA STONE“

bowl
cuenco
bol



	Ø cm	↑ cm	GN	Farbe / Colour
84560	16,5 x 16,5	5,5	0,85	■
84563	25,0 x 25,0	7,5	2,65	■



84597

Tablett „FRIDA STONE“

tray
bandeja
plateau



	Ø cm	↑ cm	GN	Farbe / Colour
84597	26,5 x 16,2	3	1/4	■
84600	35,5 x 26,0	3	-	■



GN 1/9 Schale „FRIDA STONE“

GN 1/9 bowl
GN 1/9 cuenco
GN 1/9 bol



	cm	↑ cm	GN	litr.	Farbe / Colour
84557	17,6 x 10,8	5,5	1/9	0,5	■



GN 1/6 Schale „FRIDA STONE“

GN 1/6 bowl
GN 1/6 cuenco
GN 1/6 bol



	cm	↑ cm	GN	litr.	Farbe / Colour
84585	17,6 x 16,2	7,5	1/6	1,0	■



GN 1/4 Schale

GN 1/4 bowl
GN 1/4 cuenco
GN 1/4 bol



	cm	↑ cm	GN	litr.	Farbe / Colour
84588	26,5 x 16,2	7,5	1/4	1,8	■



GN 1/2 Schale „FRIDA STONE“

GN 1/2 bowl
GN 1/2 cuenco
GN 1/2 bol



	cm	↑ cm	GN	litr.	Farbe / Colour
84591	32,5 x 26,5	7,5	1/2	4,0	■



GN 2/4 Schale „FRIDA STONE“

GN 2/4 bowl
GN 2/4 cuenco
GN 2/4 bol



	cm	↑ cm	GN	litr.	Farbe / Colour
84566	53 x 16,2	7,5	2/4	3,65	■

FLOWER POT



Schale „FLOWER POT“

bowl
cuenco
bol



	Ø cm	↑ cm	ltr.	Farbe / Colour
84470	6	3,5	0,04	
84471	6	3,5	0,04	
84472	6	3,5	0,04	

	Ø cm	↑ cm	ltr.	Farbe / Colour
84473	9	8,5	0,30	
84474	9	8,5	0,30	
84475	9	8,5	0,30	

	Ø cm	↑ cm	ltr.	Farbe / Colour
84476	12	3,5	0,20	
84478	12	3,5	0,20	

	Ø cm	↑ cm	ltr.	Farbe / Colour
84479	13	15	1,00	
84481	13	15	1,00	

	Ø cm	↑ cm	ltr.	Farbe / Colour
84482	20	9	1,80	
84484	20	9	1,80	

Deckel „UNIVERSAL“ mit Löffelaussparung / cover with notched for spoons
tapa con espacio para la cuchara / couvercle avec encoche pour la cuillère

	Ø cm	↑ cm	fits to
15341	20	1,5	84482, 84483, 84484



Schale „GLAMOUR“
bowl
cuenco
bol



	∅ cm	↑ cm	ltr.
84365	8	3	0,05



Schale „GLAMOUR“
bowl
cuenco
bol



	∅ cm	↑ cm	ltr.
84366	12	5	0,25



Schale „GLAMOUR“
bowl
cuenco
bol



	∅ cm	↑ cm	ltr.
84367	15	8	0,70

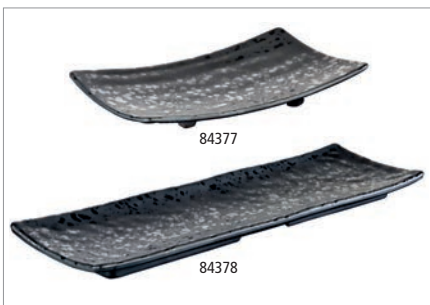

Tablett „GLAMOUR“
tray
bandeja
plateau



	cm	↑ cm
84377	22 x 12	3,0
84378	37 x 11	2,5



Tablett „GLAMOUR“
tray
bandeja
plateau



	cm	↑ cm
84380	25,0 x 15,5	1,5
84381	30,5 x 19,0	1,5



Tablett „GLAMOUR“
tray
bandeja
plateau



	cm	↑ cm
84379	30 x 11	3

OAK



Tablett „OAK“
tray
bandeja
plateau



	cm	↑ cm	→ cm
84431	17,5 x 14,5	1,5	Griff / handle 6,5
84432	22,0 x 12,0	2,0	Griff / handle 11,0



Tablett „OAK“
tray
bandeja
plateau



	cm	↑ cm
84433	20 x 20	2,5



Schale „OAK“
bowl
cuenco
bol



	cm	↑ cm
84434	11,5 x 7,0	2,5
84435	25,0 x 6,5	3,5



GN Tablett „OAK“
GN tray
GN bandeja
GN plateau



Eichenoptik
oak wood effect
imitación madera de roble
imitation chêne

	cm	↑ cm	GN
84720	53,0 x 32,5	1	1/1
84721	32,5 x 26,5	1	1/2
84722	32,5 x 17,6	1	1/3
84723	26,5 x 16,2	1	1/4
84724	53,0 x 16,2	1	2/4

OAK



Die Melaminplatten (Holzoptik Eiche) haben eine leichte Struktur und wirken optisch wie aus Holz gefertigt.

The melamine trays (superb oak wood effect) have a lightweight structure and look visually as made of wood.

Las bandejas de melamina (imitación madera de roble) tienen una estructura ligera y parecen estar hechas de madera.

Les plateaux de mélamine (imitation bois de chêne) ont une structure légère et donnent une impression visuelle de bois.



Tablett „OAK“

tray
bandeja
plateau



	∅ cm	↑ cm	→ cm
84177	30	1,5	Griff / handle 12



Tablett „OAK“

tray
bandeja
plateau



	cm	↑ cm	→ cm
84178	40 x 20	1,5	Griff / handle 13



Tablett „OAK“

tray
bandeja
plateau



	cm	↑ cm	→ cm
84179	48 x 20	1,5	Griff / handle 13

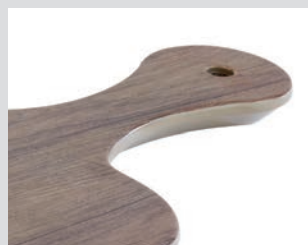



Die Melaminplatten (Holzoptik Eiche hell) haben eine leichte Struktur und wirken optisch wie aus Holz gefertigt.

The melamine trays (wood look light oak) have a lightweight structure and look visually as made of wood.

Las bandejas de melamina (imitación madera de roble claro) tienen una estructura ligera y parecen estar hechas de madera.

Les plateaux de mélamine (imitation bois de chêne clair) ont une structure légère et donnent une impression visuelle de bois.



Tablett „OAK LIGHT“

tray
bandeja
plateau



	∅ cm	↑ cm
84262	35	3
84263	44	3



Tablett „OAK LIGHT“

tray
bandeja
plateau



	cm	↑ cm
84264	44 x 25	1,5



Tablett „OAK LIGHT“

tray
bandeja
plateau



	cm	↑ cm
84265	65 x 26	3

OAK LIGHT GN



HOLZ OPTIK



84205
GN 1/1



84206
GN 1/2



84207
GN 1/3

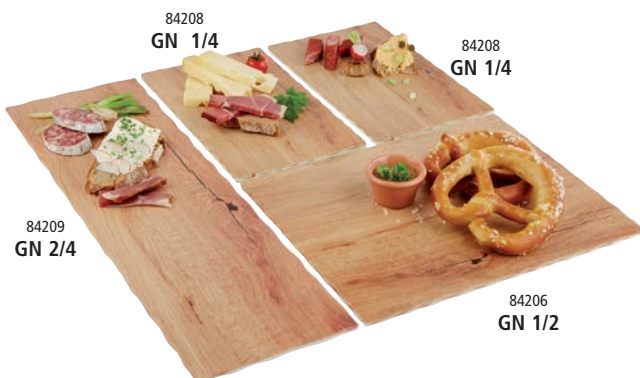

84208
GN 1/4

84208
GN 1/4

84209
GN 2/4

84206
GN 1/2

GN Tablett „OAK LIGHT“

GN tray
GN bandeja
GN plateau



	cm	↑ cm	GN
84205	53,0 x 32,5	1,5	1/1
84206	32,5 x 26,5	1,5	1/2
84207	32,5 x 17,6	1,5	1/3
84208	26,5 x 16,2	1,5	1/4
84209	53,0 x 16,2	1,5	2/4



Holzoptik Eiche hell

wood look oak light
aspecto madera, roble claro
aspect bois chêne clair



mit Antirutschfüßchen

with non-slip feet
con pies antideslizantes
avec pieds antidérapants

GN 1/1	GN 1/2	GN 1/4	GN 2/4
	GN 1/2	GN 1/4	
GN 1/3	GN 1/3	GN 1/3	

TIMBER

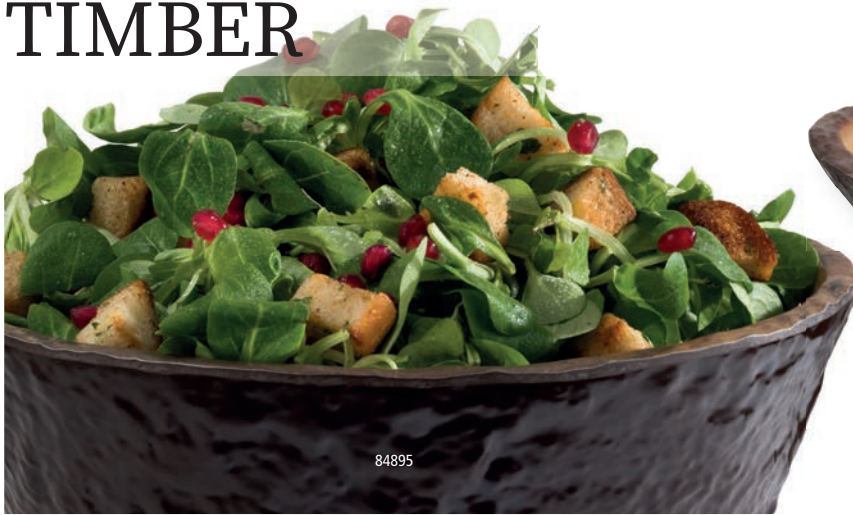

Die Melaminplatten (Holzoptik Fichte) haben eine leichte Struktur und wirken optisch wie aus Holz gefertigt.

The melamine trays (superb spruce wood effect – timber) have a lightweight structure and look visually as made of wood.

Las bandejas de melamina (imitación madera de picea) tienen una estructura ligera y parecen estar hechas de madera.

Les plateaux de mélamine (imitation bois d'épicéa) ont une structure légère et donnent une impression visuelle de bois.



Schale „TIMBER“

bowl
cuenco
bol



	cm	↑ cm	ltr.
84893	28 X 25	7,5	1,5
84894	43 X 24	7,5	2,0



Schale „TIMBER“

bowl
cuenco
bol



	Ø cm	↑ cm	ltr.
84895	25,5	15	3,0



Teller „TIMBER“

plate
plato
assiette



	Ø cm	↑ cm
84890	15	1,5



Teller „TIMBER“

plate
plato
assiette



	Ø cm	↑ cm
84891	21,5	2,5
84892	27,5	3,0



Tablett „TIMBER“

tray
bandeja
plateau



	Ø cm	↑ cm
84266	35	3
84267	44	3



Tablett „TIMBER“

tray
bandeja
plateau



	cm	↑ cm
84268	44 x 25	1,5



Tablett „TIMBER“

tray
bandeja
plateau



	cm	↑ cm
84269	65 x 26	3



Tablett „TIMBER“

tray
bandeja
plateau



	cm	↑ cm
84256	70 x 26	3

SLATE



Die schwarzen Melaminplatten überzeugen mit ihrem edlen und schlichten Schieferlook und einer rauhen Oberfläche.

The black melamine trays convince with their noble and simple slate look and a rough surface.

Las bandejas de melamina negras convencen por su aspecto de pizarra elegante y discreto y una superficie áspera.

Les plateaux en mélamine noirs convainquent grâce au aspect de l'ardoise élégant et discret et une surface rugueuse.



GN Tablett „SLATE“

GN tray
GN bandeja
GN plateau



	cm	↑ cm	GN
83955	53,0 x 32,5	1	1/1
83956	32,5 x 26,5	1	1/2
83957	32,5 x 17,6	1	1/3
83958	26,5 x 16,2	1	1/4
83971	53,0 x 16,2	1	2/4



GN Tablett „SLATE“

GN tray
GN bandeja
GN plateau



	cm	↑ cm	GN
83981	53 x 32,5	1,5	1/1



GN Tablett „SLATE“

GN tray
GN bandeja
GN plateau



massive Metallgriffe verchromt inkl. fest verschraubten 4 cm Distanzstücken
chrome plated handles, incl. mounted 4 cm distance pillars
asas cromadas, incluye distanciadores a 4 cm
poignées chromées, distance approx. 4 cm

	cm	↑ cm	GN
83980	53 x 32,5	6	1/1



Tablett „SLATE“

tray
bandeja
plateau



	cm	↑ cm
84960	28 x 17,5	2,5



Ø 2,5 cm

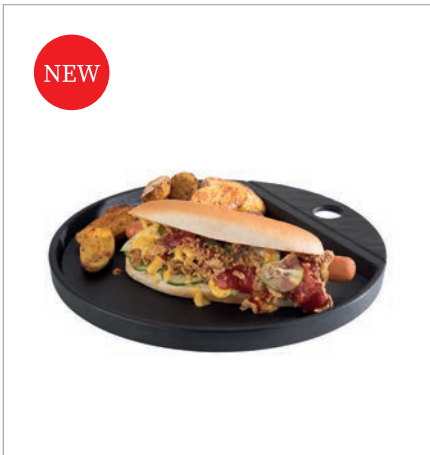

Tablett „SLATE“

tray
bandeja
plateau



	Ø cm	↑ cm
84961	28	2,5



Ø 2,5 cm



Tablett „SLATE“

tray
bandeja
plateau



	Ø cm	↑ cm
83992	30	1
83994	40	1



Schale „SLATE“

bowl
cuenco
bol



	cm	↑ cm	litr.
84244	19 x 19	9	1,5
84245	25 x 25	12	3,8

Deckel „PURE“ mit Löffelaussparung / cover with notched for spoons
tapa con espacio para la cuchara / couvercle avec encoche pour la louche

	cm	↑ cm	fits to
83600	19 x 19	1,5	84244
83601	25 x 25	1,5	84245

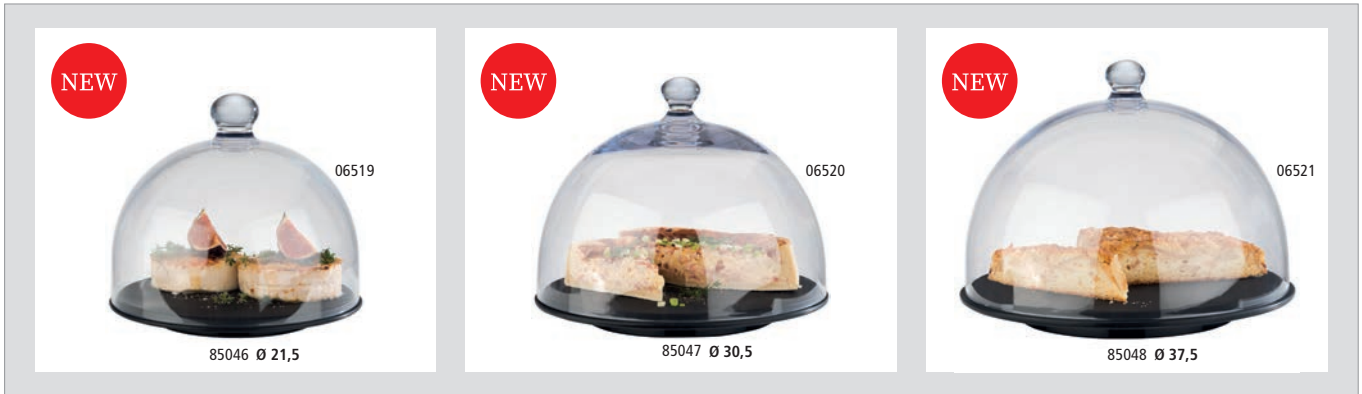

Torten- / Konditorplatte „SLATE“
 cake stand
 soporte para pastel
 présentoir à gâteaux



Rand fixiert die Haube, mit Antirutsch-Füßchen
 carved edge fixes the cover, with non-slip feet
 ranura para fijar bien la campana, con pies antideslizantes
 bord rainuré pour maintenir ferme la cloche, avec pieds antidérapants

	Ø cm	↑ cm
85046	21,5	2,5
85047	30,5	3,5
85048	37,5	4

Frischhalte- Haube / cover / campana / cloche



	Ø cm	↑ cm	fits to
06519 NEW	21	17	85046
06520	30	22	85047
06521 NEW	36	27	85048



Tablett „SLATE“
 tray
 bandeja
 plateau



	Ø cm	↑ cm	→ cm	
84241	23,0	1,5	10	Ø Loch 2 cm
84242	33,5	1,5	14	Ø Loch 2,5 cm

Frischhalte- Haube / cover / campana/ cloche



	Ø cm	↑ cm	fits to
06520	30,0	22	84242, 84177, 83891, 83890, 83884, 15303, 998, 975, 469, 468, 463, 462 46,
15351	20,5	10	84241

SLATE ROCK



Buffet & Tableware
Melamin



Tablett „SLATE-ROCK“

tray
bandeja
plateau



Die schwarzen Melaminplatten überzeugen mit ihrem Schieferlook
 The black melamine trays convince with their slate look
 Las bandejas de melamina negras convencen por su aspecto de pizarra
 Les plateaux en mélamine noirs convainquent grâce au aspect de l'ardoise

	∅ cm	↑ cm	→ cm
84257	30	1,5	Griff 12
	cm	↑ cm	→ cm
84258	40 x 20	1,5	Griff 13
84259	48 x 20	1,5	Griff 13

Buffet & Tableware Melamin

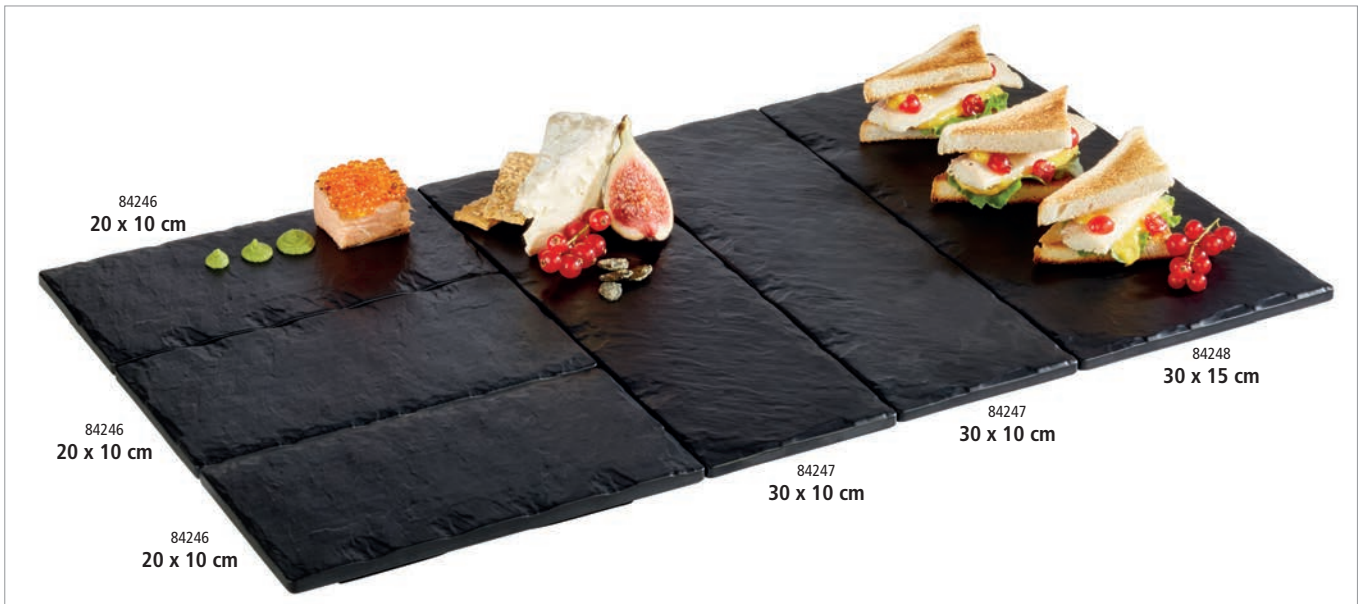

Tablett „SLATE-ROCK“

tray
bandeja
plateau



Die schwarzen Melaminplatten überzeugen mit ihrem Schieferlook

The black melamine trays convince with their slate look

Las bandejas de melamina negras convencen por su aspecto de pizarra

Les plateaux en mélamine noirs convainquent grâce au aspect de l'ardoise

	cm	↑ cm
84246	20 x 10	2
84247	30 x 10	2
84248	30 x 15	2



1:1 Oberflächenansicht

1:1 structural view

GN Tablett „ROCKFACE“

GN tray
GN bandeja
GN plateau



die Melaminplatten (Steinoptik) haben eine leicht wellige Oberfläche und wirken optisch wie ein Naturstein

the melamine trays (imitation of stone) have a slightly wavy surface and look visually as made of natural stone

las bandejas de melamina (imitación piedra) tienen una superficie ligeramente ondulada y parecen estar hechas de piedra natural

les plateaux de mélamine (imitation pierre) ont une surface légèrement ondulée et donnent une impression visuelle de pierre naturelle

	cm	↑ cm	GN
84770	53,0 x 32,5	1,5	1/1
84771	32,5 x 26,5	1,5	1/2
84772	32,5 x 17,6	1,5	1/3
84773	26,5 x 16,2	1,5	1/4
84774	53,0 x 16,2	1,5	2/4



GN Tablett „ZERO“

GN tray
GN bandeja
GN plateau



glatte, hochglänzende Oberfläche
smooth and shiny surface
superficie lisa con acabado brillante
surface lisse et finition brillante

	cm	↑ cm	GN	Farbe / Colour
84185	53,0 x 32,5	1,5	1/1	
84186	32,5 x 26,5	1,5	1/2	
84187	32,5 x 17,6	1,5	1/3	
84188	26,5 x 16,2	1,5	1/4	
84189	53,0 x 16,2	1,5	2/4	
84195	53,0 x 32,5	1,5	1/1	
84196	32,5 x 26,5	1,5	1/2	
84197	32,5 x 17,6	1,5	1/3	
84198	26,5 x 16,2	1,5	1/4	
84199	53,0 x 16,2	1,5	2/4	



GN Tablett „DRIFTWOOD“

GN tray
GN bandeja
GN plateau



die Melaminplatten (Holzoptik) haben eine leicht wellige Oberfläche und wirken optisch wie aus Holz gefertigt
the melamine trays (wood look) have a slightly wavy surface and look visually as made of natural wood
las bandejas de melamine (imitación madera) tienen una superficie ligeramente ondulada y parecen estar hechas de madera natural
les plateaux de mélamine (imitation bois) ont une surface légèrement ondulée et donnent une impression visuelle de bois naturelle

	cm	↑ cm	GN
84180	53,0 x 32,5	1,5	1/1
84181	32,5 x 26,5	1,5	1/2
84182	32,5 x 17,6	1,5	1/3
84183	26,5 x 16,2	1,5	1/4
84184	53,0 x 16,2	1,5	2/4

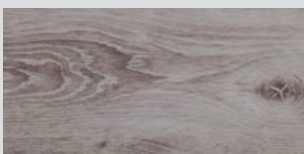

1:1 Oberflächenansicht
1:1 structural view



CIRCLE



Tablett „CIRCLE“
plate / tray
plato / bandeja
assiette / plateau



	Ø cm	↑ cm	Farbe / Colour
84875	32,0	3,5	
84876	40,5	5,5	



LA VIDA



Tablett „LA VIDA“
plate / tray
plato / bandeja
assiette / plateau



	Ø cm	↑ cm	Farbe / Colour
84165	32,0	3,5	
84168	40,5	5,5	

	Ø cm	↑ cm	Farbe / Colour
84161	32,0	3,5	
84170	40,5	5,5	

	Ø cm	↑ cm	Farbe / Colour
84171	32,0	3,5	
84172	40,5	5,5	



MARONE

Eine derbe Oberflächenstruktur schafft ein natürliches Erscheinungsbild. Die schwarzen Schalenvarianten mit braunem Rand inszenieren Ihr Gericht sehr stilvoll.

A rough surface structure creates a natural appearance. The black bowls and trays with brown border stage your dishes in a very stylish way.

La estructura rugosa de la superficie crea una apariencia natural. Los diferentes cuencos negros con borde marron ponen con mucho estilo en escena sus platos.

La structure de surface rugueuse crée une apparence naturelle. Les différents bols noirs avec rebord marron mettent élégamment en scène vos plats.



84101

Blattschale „MARONE“
leaf
fuente en forma de hoja
plateau feuille



	cm	↑ cm	ltr.
84100	25,5 x 14	5,5	0,4
84101	36,0 x 19	8,0	0,9



84104

Tablett „MARONE“
tray
bandeja
plateau



	cm	↑ cm
84104	22,5 x 15	3
84105	27,5 x 11	2



Tablett „MARONE“
tray
bandeja
plateau



	cm	↑ cm
84103	14,5 x 14,5	2



Tablett „MARONE“
tray
bandeja
plateau



	cm	↑ cm
84106	26,5 x 16,5	4



Schale „MARONE“

bowl
cuenco
bol



	cm	↑ cm	ltr.
84731	16,5 x 10	5,5	0,25
84732	22,0 x 13	7,5	0,6
84733	27,5 x 19	9,0	1,4



Teller „MARONE“

plate
plato
assiette



	Ø cm	↑ cm
84728	16,0	2,5
84729	20,5	2,5
84730	28,0	3,5



Schale „MARONE“

bowl
cuenco
bol



	Ø cm	↑ cm	ltr.
84109	11	5,5	0,2



Schale „MARONE“

bowl
cuenco
bol



	Ø cm	↑ cm	ltr.
84107	8,5	2,5	0,05
84108	11,5	3,0	0,04



Tablett „MARONE“

tray
bandeja
plateau



	cm	↑ cm
84117	19,5 x 9,5	2
84118	39,0 x 16,0	3



Tablett „MARONE“

tray
bandeja
plateau



	cm	↑ cm
84119	32,5 x 23,5	4,5



Schale „MARONE“

bowl
cuenco
bol



	Ø cm	↑ cm	ltr.
84174	30,5	8,5	2



Schale „MARONE“

bowl
cuenco
bol



	Ø cm	↑ cm	ltr.
84110	14	6,0	0,30
84111	19	8,0	0,80
84112	21	8,5	1,00
84113	24	9,5	1,40



Schale „MARONE“

bowl
cuenco
bol



	cm	↑ cm	ltr.
84114	23,5 x 23,5	6,5	0,70



Schale „MARONE“

bowl
cuenco
bol



	Ø cm	↑ cm	ltr.
84115	11	3,5	0,13
84116	14	4,0	0,20

DARK WAVE



GN Tablett „DARK WAVE“

GN tray
GN bandeja
GN plateau



	cm	↑ cm	GN
84900	53,0 x 32,5	2	1/1
84901	32,5 x 26,5	2	1/2
84902	32,5 x 17,6	2	1/3
84903	53,0 x 16,2	2	2/4

GN 1/1	GN 1/2	GN 2/4	GN 1/3	mit Antirutsch- füßchen non-slip feet
	GN 1/2		GN 1/3	
			GN 1/3	



Tablett „DARK WAVE“

tray
bandeja
plateau



	cm	↑ cm
84904	14 x 14	2



Tablett „DARK WAVE“

tray
bandeja
plateau



	cm	↑ cm
84905	23 x 10,5	1,5
84906	29 x 12,0	1,5

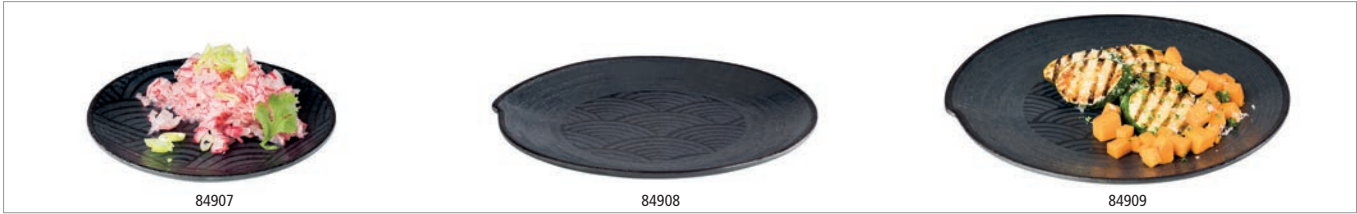

Teller „DARK WAVE“

plate
plato
assiette



	Ø cm	↑ cm
84907	14,5	1,5
84908	22,0	2,0
84909	27,0	2,5



Schale „DARK WAVE“

bowl
cuenco
bol



	Ø cm	↑ cm	litr.
84910	17,5	5,0	0,50
84911	22,5	5,0	0,75
84912	32,0	3,5	-
84913	40,5	5,5	-



Schale „DARK WAVE“

bowl
cuenco
bol



	cm	↑ cm	litr.
84914	18 x 18	10,0	1,6
84915	23 x 23	11,5	2,9

ZEN

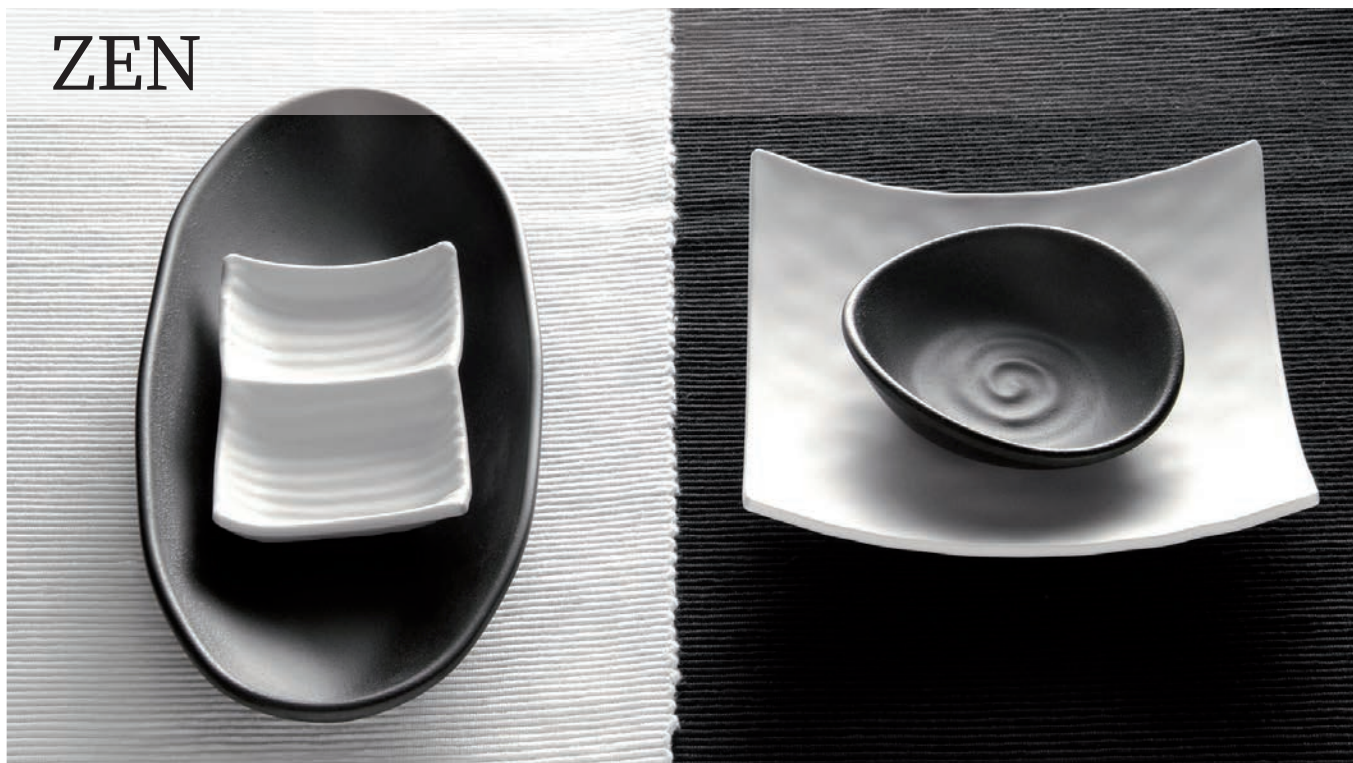

Fernöstliche Tisch- und Buffetartikel präsentiert die Serie ZEN. Die Optik entspricht dem japanischen Steingut.

The ZEN series presents Far Eastern table and buffet articles. The appearance is that of Japanese stoneware.

La colección ZEN presenta artículos de buffet y mesa para la cocina oriental. Su aspecto recuerda al gres japonés.

La collection ZEN présente des articles de buffet et de table pour la cuisine orientale. L'aspect de la mélamine rappelle le grès japonais.



Schale „ZEN“
bowl
cuenco
bol



	Ø cm	↑ cm	ltr	Farbe / Colour
83928	31	8,5	2,5	White
83929	31	8,5	2,5	Black



Schale „ZEN“
bowl
cuenco
bol



	Ø cm	↑ cm	ltr.	Farbe / Colour
84354	22,5	12,5	0,80	White
84355	22,5	12,5	0,80	Black



Schale „ZEN“
bowl
cuenco
bol



	cm	↑ cm	ltr.	Farbe / Colour
83710	21 x 21	11	1,40	White
83712	21 x 21	11	1,40	Black



Schale „ZEN“

bowl
cuenco
bol



	Ø cm	↑ cm	ltr.	Farbe / Colour
84348	10,0	7,0	0,08	■
84350	12,5	8,5	0,15	■
84352	16,0	10,0	0,30	■

	Ø cm	↑ cm	ltr.	Farbe / Colour
84349	10,0	7,0	0,08	■
84351	12,5	8,5	0,15	■
84353	16,0	10,0	0,30	■



stapelbar
stackable



Schale „ZEN“

bowl
cuenco
bol



	cm	↑ cm	ltr.	Farbe / Colour
83735	25,0 x 13,5	4	0,25	■
83739	30,5 x 17,5	5	0,60	■



Schale „ZEN“

bowl
cuenco
bol



	cm	↑ cm	ltr.	Farbe / Colour
83714	17,5 x 17,5	7	0,5	■
83716	17,5 x 17,5	7	0,5	■



Schale „ZEN“

bowl
cuenco
bol



	cm	↑ cm	ltr.	Farbe / Colour
83725	10,5 x 10,5	3	0,06	■
83727	10,5 x 10,5	3	0,06	■



Dipschälchen „ZEN“

dip bowl
cuenco para dip
bol para dip



	∅ cm	↑ cm	ltr.	Farbe / Colour
83721	8	1,5	0,03	■
83723	8	1,5	0,03	■



Schale „ZEN“

bowl
cuenco
bol



	cm	↑ cm	ltr.	Farbe / Colour
83718	12 x 12	4	0,2	■
83720	12 x 12	4	0,2	■



Schale „ZEN“

bowl
cuenco
bol



	cm	↑ cm	ltr.	Farbe / Colour
83726	13 x 11	3,5	0,1	■
83728	13 x 11	3,5	0,1	■



Schale „ZEN“

bowl
cuenco
bol



	cm	↑ cm	ltr.	Farbe / Colour
83730	11 x 10	3	0,04	■
83732	11 x 10	3	0,04	■



Schale „ZEN“

bowl
cuenco
bol



	cm	↑ cm	ltr.	Farbe / Colour
83722	17,5 x 15,5	5,5	0,2	■
83724	17,5 x 15,5	5,5	0,2	■



Schale „ZEN“

bowl
cuenco
bol



	cm	↑ cm	ltr.	Farbe / Colour
83934	14,5 x 12,5	5	0,2	■
83935	14,5 x 12,5	5	0,2	■



Schale „ZEN“

bowl
cuenco
bol



	∅ cm	↑ cm	ltr.	Farbe / Colour
83932	11,5	4	0,15	■
83933	11,5	4	0,15	■



Schale „ZEN“

bowl
cuenco
bol



	cm	↑ cm	ltr.	Farbe / Colour
83946	9 x 7	2,5	0,05	■
83947	9 x 7	2,5	0,05	■



Schale „ZEN“

bowl
cuenco
bol



	cm	↑ cm	Farbe / Colour
83948	14 x 9	2,5	■
83949	14 x 9	2,5	■



Tablett / Teller „ZEN“

tray / plate
bandeja / plato
plateau / assiette



	∅ cm	↑ cm	Farbe / Colour
83940	28	3	
83941	28	3	



Tablett „ZEN“

tray
bandeja
plateau



	cm	↑ cm	Farbe / Colour
83734	23,5 x 23	5,5	
83736	23,5 x 23	5,5	



Tablett / Sushiboard „ZEN“

tray / sushiboard
bandeja para sushi
plateau sushi



	cm	↑ cm	Farbe / Colour
83742	22,5 x 9,5	3	
83744	22,5 x 9,5	3	



Tablett / Sushiboard „ZEN“

tray / sushiboard
bandeja para sushi
plateau sushi



	cm	↑ cm	Farbe / Colour
83738	22 x 12	3	
83740	22 x 12	3	

FUSION



Die Oberflächen der Serie FUSION sind innen hoch glänzend und außen mattiert. Das besondere Design beansprucht höchste Aufmerksamkeit und bringt Speisen optimal zur Geltung. Die Speisen werden noch mehr in den Blickpunkt gerückt.

The surfaces of the FUSION series have a mirror shiny inside and a matte outside. The unique design demands the utmost attention. The food moves even more in the focus.

Las superficies de la serie FUSION tienen un interior brillante y un exterior mate. El diseño único exige la máxima atención. Los platos reciben un enfoque aún mayor.

Les surfaces de la série FUSION sont brillantes à l'intérieur et mates à l'extérieur. Le design spéciale exige la plus grande attention. Les plats sont mise encore plus dans le centre de l'attention.



Schale „FUSION“

owl
cuenco
bol



	Ø cm	↑ cm	ltr.
84022	11	7,0	0,3
84023	17	8,5	1,0
84024	20	8,0	1,2



Tablett „FUSION“

tray
bandeja
plateau



	cm	↑ cm
84025	23,5 x 7,5	2

SINUS



Charakterstark und mit dem Anspruch an Funktionalität und Design präsentiert sich die Buffetserie SINUS. Die großzügigen Flächen für die Speisenpräsentation sind ausdrucksstark eingefasst und gewährleisten ein optimales Handling.

The SINUS buffet series is characterful and with a high standard of functionality and design. The spacious areas for the food presentation are expressively enclosed and ensure optimal handling in everyday dining.

La serie de buffet SINUS demuestra un carácter fuerte y tiene un alto nivel de funcionalidad y diseño. Las áreas espaciales para la presentación de la comida son expresivamente enmarcadas y aseguran un manejo óptimo en la gastronomía.

La série de buffet SINUS est pleine de caractère et avec un haut niveau de fonctionnalité et de design. Les zones spacieuses pour la présentation de la nourriture sont expressivement encadrées et assurent une maniabilité optimale dans la restauration.



GN Tablett „SINUS“

GN tray
GN bandeja
GN plateau



	cm	↑ cm	GN	Farbe / Colour
84230	53 x 32,5	2	1/1	White
84231	53 x 16,2	2	2/4	White
	cm	↑ cm	GN	Farbe / Colour
84260	53 x 32,5	2	1/1	Black
84261	53 x 16,2	2	2/4	Black



Schale „SINUS“

bowl
cuenco
bol



	cm	↑ cm	ltr.
84229	10,5 x 10,5	4,0	0,1
84232	21,0 x 21,0	9,0	1,5
84233	25,0 x 25,0	11,0	2,4
84234	28,5 x 28,5	12,5	3,5

HALFTONE



Fingerfood Löffel „HALFTONE“

party spoon
cuchara party
cuillère party



	Ø cm	↑ cm
84158	5,5	7



Fingerfood Löffel „HALFTONE“

party spoon
cuchara party
cuillère party



	cm	↑ cm
84128	14,5 x 4,5	4,5



Tablett „HALFTONE“

tray
bandeja
plateau



	cm	↑ cm
84124	20,5 x 12,5	3
84125	24,5 x 15,0	3
84127	34,5 x 21,5	3



Tablett „HALFTONE“

tray
bandeja
plateau



	cm	↑ cm
84126	29 x 18	4



Schale „HALFTONE“

bowl
cuenco
bol



	∅ cm	↑ cm	ltr.
84217	8	4	0,1



Schale „HALFTONE“

bowl
cuenco
bol



	∅ cm	↑ cm	ltr.
84218	8,5	3,5	0,05



84130

Schale „HALFTONE“

bowl
cuenco
bol



	cm	↑ cm	ltr.
84130	11,5 x 7,0	4,0	0,05
84131	14,0 x 8,0	4,5	0,10
84132	15,0 x 9,5	5,0	0,15



84134

Schale „HALFTONE“

bowl
cuenco
bol



	cm	↑ cm	ltr.
84133	17,5 x 13,5	6,5	0,35
84134	24,0 x 17,5	7,5	0,8



84136

Schale „HALFTONE“

bowl
cuenco
bol



	cm	↑ cm	ltr.
84135	16,5	7,5	0,65
84136	19,0	8,5	1,00



Schale „HALFTONE“

bowl
cuenco
bol



	cm	↑ cm	ltr.
84137	26	9	1,5

TAO



Schale, rund „TAO“ bowl, round cuenco, redondo bol, rond



	cm	↑ cm	ltr.	Farbe / Colour
83648	10,5 x 10,0	6,5 / 3,0	0,07	White
83651	13,5 x 12,5	8,5 / 4,0	0,15	White
83654	17,0 x 16,0	10,5 / 4,5	0,3	White
	cm	↑ cm	ltr.	Farbe / Colour
83649	10,5 x 10,0	6,5 / 3,0	0,07	Black
83652	13,5 x 12,5	8,5 / 4,0	0,15	Black
83655	17,0 x 16,0	10,5 / 4,5	0,3	Black



Schale, quadratisch „TAO“ bowl, square cuenco, cuadrado bol creux carré



	cm	↑ cm	ltr.	Farbe / Colour
83642	30,5 x 30,5	10	3,3	White
83643	30,5 x 30,5	10	3,3	Black



Schale, rechteckig „TAO“ bowl, rectangular cuenco, rectangular bol creux rectangulaire



	cm	↑ cm	ltr.	Farbe / Colour
83639	32,5 x 17,5	10	1,8	White
83640	32,5 x 17,5	10	1,8	Black

APART



GN Tablett „APART“

GN tray
GN bandeja
GN plateau



	cm	↑ cm	GN
83828	53,0 x 32,5	2,5	1/1
83830	32,5 x 26,5	2,5	1/2
83832	32,5 x 17,6	2,5	1/3



Tablett „APART“

tray
bandeja
plateau



	cm	↑ cm
83834	23,0 x 23,0	2,5
83836	33,0 x 33,0	2,5



Schale, rund „APART“

bowl, round
cuenco, redondo
bol, rond



	Ø cm	↑ cm	litr.
83800	6,5	3,0	0,045

Schale, eckig „APART“

bowl, square
cuenco, cuadrado
bol, carré



	cm	↑ cm	litr.
83808	6,6 x 6,6	3,0	0,05
83810	10 x 10	4,5	0,17
83812	15 x 15	6,5	0,5
83814	20 x 20	9,0	1,6
83816	25 x 25	9,0	2,6
83818	25 x 25	12,5	3,8
83820	30 x 30	12,5	4,5



GN 2/4 Schale „APART“

GN 2/4 bowl
GN 2/4 cuenco
GN 2/4 bol



	cm	↑ cm	GN	litr.
83826	53,0 x 16,2	6,5	2/4	3,0



Schale „GLOBAL BUFFET“

bowl
cuenco
bol



	cm	↑ cm	ltr.	Farbe / Colour
83785	32,5 x 32,5	12,0	3,0	White
83786	35,0 x 35,0	12,5	3,5	White
83787	40,0 x 40,0	13,5	5,0	White
	cm	↑ cm	ltr.	Farbe / Colour
84785	32,5 x 32,5	12,0	3,0	Black
84786	35,0 x 35,0	12,5	3,5	Black
84787	40,0 x 40,0	13,5	5,0	Black



Schale „GLOBAL BUFFET“

bowl
cuenco
bol



	cm	↑ cm	ltr.	Farbe / Colour
84464	35,5 x 31,5	14,0	2,5	White
84466	46,0 x 40,0	18,5	5,5	White



Schale „GLOBAL BUFFET“

bowl
cuenco
bol



	cm	↑ cm	ltr.	Farbe / Colour
84462	44 x 25	20	3,3	White



Schale „GLOBAL BUFFET“

bowl
cuenco
bol



	cm	↑ cm	ltr.	Farbe / Colour
83799	25,5 x 25,5	13,0	3,0	White
83788	32,0 x 32,0	16,5	4,5	White
83789	35,0 x 35,0	17,0	6,0	White
83790	40,0 x 40,0	17,5	8,0	White
	cm	↑ cm	ltr.	Farbe / Colour
83779	25,5 x 25,5	13,0	3,0	Black
84788	32,0 x 32,0	16,5	4,5	Black
84789	35,0 x 35,0	17,0	6,0	Black
84790	40,0 x 40,0	17,5	8,0	Black



Schale „GLOBAL BUFFET“

bowl
cuenco
bol



die Melaminschale wirkt optisch wie der Naturstein Granit
the melamine bowl looks visually as made of natural granit stone
el cuenco de melamina parece estar hecho de granito natural
le bol de mélamine donne une impression visuelle de granit naturel

	cm	↑ cm	ltr.	Farbe / Colour
84387	36 x 36	11	3,5	Black

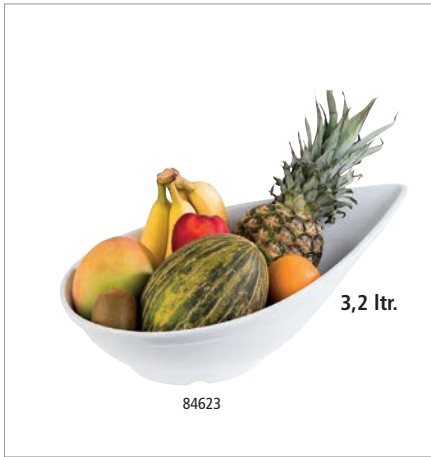

Schale „GLOBAL BUFFET“

bowl
cuenco
bol



	cm	↑ cm	ltr.	Farbe / Colour
84622	42 x 27	14	2,2	_____
84623	50 x 32	17	3,2	_____



Schale „LEAF“

bowl
cuenco
bol



	cm	↑ cm	ltr.	Farbe / Colour
84200	42 x 19,5	6,5	1,0	_____
84202	50 x 23,0	7,5	1,5	_____



Schale „BIG WAVE“

bowl
cuenco
bol



	cm	↑ cm	ltr.	Farbe / Colour
83587	33 x 24	8,5	1	_____



Etagère „CASUAL“

etagère
expositor
présentoir



inklusive Edelstahl-Schild, beschriftbar
including stainless steel sign, inscribable
placa de acero inoxidable incluida, rotulable
étiquette en acier inox incluse, inscriptible

	Ø cm	↑ cm	
34248	31 - 41 - 51	55	3-stufig / 3-tier 3 niveles / 3 étages
34247	31 - 41	35	2-stufig / 2-tier 2 niveles / 2 étages

FLYING BUFFET



Buffet & Tableware
Melamin



Fingerfood-Teller „FLYING BUFFET“

fingerfood plate
plato para el aperitivo
assiette pour apéritif



	cm	↑ cm	Farbe / Colour
83878	9,5 x 9,5	1,5 / 3,5	White
83879	9,5 x 9,5	1,5 / 3,5	Black



Schale „FLOAT“

bowl
cuenco
bol



	cm	↑ cm	Farbe / Colour
83912	9 x 9	4,5	White
83913	9 x 9	4,5	Black



GN Tablett „APART“

GN tray
GN bandeja
GN plateau



	cm	↑ cm	GN
83828	53 x 32,5	2,5	1/1



GN Edelstahl Tablett „FRAMES“

GN stainless steel platter
GN bandeja de acero inoxidable
GN plateau en acier inox



	cm	GN
11119	53 x 32,5	1/1

CASCADE



Schale „CASCADE“

bowl
cuenco
bol



	cm	↑ cm	GN	ltr.
83963	28,5 x 25,5	7,5		2,90
83960	32,5 x 26,5	7,5	1/2	3,65
83962	26,5 x 16,2	7,5	1/4	1,50



Tablett „CASCADE“

tray
bandeja
plateau



	cm	↑ cm	GN	fits to
83964	28,5 x 25,5	2,4		83963
83965	32,5 x 26,5	2,4	1/2	83960
83967	26,5 x 16,2	2,4	1/4	83962



Tablett kann als Deckel eingesetzt werden!

Tray is also useable as a cover!

¡La bandeja se puede usar como tapa!

Le plat s'utilise aussi comme couvercle!



Gastronorm - Außenmaße Gastronorm - size Gastronorm - medidas exteriores Gastronorme - Gastronorme dimensions extérieures



GN 2/4 Schale „CASCADE“

GN 2/4 bowl
GN 2/4 cuenco
GN 2/4 bol



	cm	↑ cm	GN	ltr.
83961	53 x 16,2	7,5	2/4	3,65



GN 2/4 Tablett „CASCADE“

GN 2/4 tray
GN 2/4 bandeja
GN 2/4 plateau



	cm	↑ cm	GN	fits to
83966	53 x 16,2	2,4	2/4	83961





- Ideal für den Thekenbereich
- stapelbar mit Löffel und Deckel
- Schalenboden fixiert sich auf dem Deckel
- rutschfest (Antirutschfüßchen)

- ideal for the counter area
- stackable with spoon and lid
- the bottom of the bowl is fixed on the lid
- non-slip (with non-slip feet)

- idéal pour l'aire de comptoir
- empilable avec cuillère et couvercle
- le fond du bol se fixe sur le couvercle
- antidérapant (avec pieds antidérapants)



Schale „FLOAT“
bowl
cuenco
bol

	Ø cm	↑ cm	ltr.	Farbe / Colour
83900	5,5	3,0	0,03	White
83902	9,0	4,5	0,15	White
83904	13,0	6,5	0,45	White
83906	15,0	7,5	0,70	White
83908	20,5	10,0	1,90	White
<hr/>				
	Ø cm	↑ cm	ltr.	Farbe / Colour
83901	5,5	3,0	0,03	Black
83903	9,0	4,5	0,15	Black
83905	13,0	6,5	0,45	Black
83907	15,0	7,5	0,70	Black
83909	20,5	10,0	1,90	Black



Schale „FLOAT“

bowl
cuenco
bol



	cm	↑ cm	ltr.	Farbe / Colour
83910	5,5 x 5,5	3,0	0,03	White
83912	9,0 x 9,0	4,5	0,16	White
83914	12,5 x 12,5	6,0	0,50	White
83916	19,0 x 19,0	9,5	1,90	White
83918	25,0 x 25,0	12,0	4,70	White
	cm	↑ cm	ltr.	Farbe / Colour
83911	5,5 x 5,5	3,0	0,03	Black
83913	9,0 x 9,0	4,5	0,16	Black
83915	12,5 x 12,5	6,0	0,50	Black
83917	19,0 x 19,0	9,5	1,90	Black
83919	25,0 x 25,0	12,0	4,70	Black



GN Tablett „FLOAT“

GN tray
GN bandeja
GN plateau



	cm	↑ cm	GN	Farbe / Colour
83923	53,0 x 32,5	3	1/1	White
83925	32,5 x 26,5	3	1/2	White
	cm	↑ cm	GN	Farbe / Colour
83924	53,0 x 32,5	3	1/1	Black
83926	32,5 x 26,5	3	1/2	Black



Deckel „FLOAT“ mit Löffelaussparung

cover, with notched for spoons
tapa, con espacio para la cuchara
couverture, avec encoche pour la louche



	Ø cm	↑ cm	fits to
83920	20,5	1,3	83908, 83909



Deckel „FLOAT“ mit Löffelaussparung

cover, with notched for spoons
tapa, con espacio para la cuchara
couverture, avec encoche pour la louche



	cm	↑ cm	fits to
83921	19 x 19	1,3	83916, 83917
83922	25 x 25	1,3	83918, 83919

PURE



Tablett „PURE“
tray
bandeja
plateau



	cm	↑ cm	GN	Farbe / Colour
83401	53,0 x 32,5	3	1/1	White
83588	35,4 x 32,5	3	2/3	White
83433	53,0 x 16,2	3	2/4	White
83480	32,5 x 26,5	3	1/2	White
83481	32,5 x 17,6	3	1/3	White
83482	26,5 x 16,2	3	1/4	White
83882	65,0 x 26,5	3		White
83597	40,0 x 30,0	3	Bäcker-Maß	White
83598	60,0 x 20,0	3	Bäcker-Maß	White
83599	60,0 x 40,0	3	Bäcker-Maß	White

	cm	↑ cm	GN	Farbe / Colour
83479	53,0 x 32,5	3	1/1	Black
83589	35,4 x 32,5	3	2/3	Black
83434	53,0 x 16,2	3	2/4	Black
83490	32,5 x 26,5	3	1/2	Black
83491	32,5 x 17,6	3	1/3	Black
83492	26,5 x 16,2	3	1/4	Black
83592	40,0 x 30,0	3	Bäcker-Maß	Black
83593	60,0 x 20,0	3	Bäcker-Maß	Black
83594	60,0 x 40,0	3	Bäcker-Maß	Black



Tablett „PURE“

tray
bandeja
plateau



	cm	↑ cm	Farbe / Colour
83625	31,0 x 10,5	2	
83403	35,5 x 18,0	3	
83417	30,0 x 21,0	3	
83402	53,0 x 18,0	3	

	cm	↑ cm	Farbe / Colour
83483	53 x 18	3	



Tablett „PURE COLOR“

tray
bandeja
plateau



	cm	↑ cm	GN	Farbe / Colour
83560	53,0 x 32,5	3	1/1	
83562	32,5 x 26,5	3	1/2	
83561	53,0 x 32,5	3	1/1	
83563	32,5 x 26,5	3	1/2	



Tablett quadratisch „PURE“

tray square
bandeja cuadrada
plateau carré



	cm	↑ cm	Farbe / Colour
83418	18,0 x 18,0	3	
83407	21,0 x 21,0	3	
83406	26,5 x 26,5	3	
83405	37,0 x 37,0	3	
83404	51,0 x 51,0	3	

	cm	↑ cm	Farbe / Colour
83400	51 x 51	3	



Tablett / Teller „PURE“

tray / plate
bandeja / plato
plateau / assiette



	Ø cm	↑ cm	Farbe / Colour
83884	31	2,5	
83869	38	2,5	
83886	41	2,5	
83484	51	2,5	



Schale „PURE“

bowl
cuenco
bol



	Ø cm	↑ cm	ltr.	Farbe / Colour
83450	5,5	4,0	0,02	White
83419	9,0	4,5	0,09	White
83453	13,0	6,5	0,30	White
83455	15,0	7,5	0,45	White
83415	20,0	10,5	1,25	White
	Ø cm	↑ cm	ltr.	Farbe / Colour
83451	5,5	4,0	0,02	Black
83452	9,0	4,5	0,09	Black
83454	13,0	6,5	0,30	Black
83456	15,0	7,5	0,45	Black
83457	20,0	10,5	1,25	Black



Teller, rund „CASUAL“

plate, round
plato, redondo
assiette, ronde



	Ø cm	↑ cm
83500	22,5	2,5
83514	26,5	2,5



0,05 ltr. - 8,0 ltr.

Schale „PURE COLOR“

bowl
cuenco
bol



	cm	↑ cm	ltr.	Farbe / Colour
84424	6,5 x 6,5	3,0	0,05	White
83414	9,0 x 9,0	4,0	0,14	White
83410	12,5 x 12,5	6,5	0,40	White
83409	19,0 x 19,0	9,0	1,50	White
83408	25,0 x 25,0	12,0	3,80	White
84425	32,0 x 32,0	14,0	8,0	White
	cm	↑ cm	ltr.	Farbe / Colour
84426	6,5 x 6,5	3,0	0,05	Black
83466	9,0 x 9,0	4,0	0,14	Black
83467	12,5 x 12,5	6,5	0,40	Black
83468	19,0 x 19,0	9,0	1,50	Black
83469	25,0 x 25,0	12,0	3,80	Black
84427	32,0 x 32,0	14,0	8,0	Black
	cm	↑ cm	ltr.	Farbe / Colour
83568	9,0 x 9,0	4,0	0,14	Grey
83570	12,5 x 12,5	6,5	0,40	Grey
83572	19,0 x 19,0	9,0	1,50	Grey
83574	25,0 x 25,0	12,0	3,80	Grey
	cm	↑ cm	ltr.	Farbe / Colour
83569	9,0 x 9,0	4,0	0,14	Olive Green
83571	12,5 x 12,5	6,5	0,40	Olive Green
83573	19,0 x 19,0	9,0	1,50	Olive Green
83575	25,0 x 25,0	12,0	3,80	Olive Green



Schale „PURE BICOLOR“

bowl
cuenco
bol



	cm	↑ cm	ltr.	Farbe / Colour
84414	9,0 x 9,0	4,0	0,14	■ ■
84410	12,5 x 12,5	6,5	0,40	■ ■
84409	19,0 x 19,0	9,0	1,50	■ ■
84408	25,0 x 25,0	12,0	3,80	■ ■

	cm	↑ cm	ltr.	Farbe / Colour
84420	9,0 x 9,0	4,0	0,14	■ ■
84421	12,5 x 12,5	6,5	0,40	■ ■
84422	19,0 x 19,0	9,0	1,50	■ ■
84423	25,0 x 25,0	12,0	3,80	■ ■

	cm	↑ cm	ltr.	Farbe / Colour
84415	9,0 x 9,0	4,0	0,14	■ ■
84416	12,5 x 12,5	6,5	0,40	■ ■
84417	19,0 x 19,0	9,0	1,50	■ ■
84418	25,0 x 25,0	12,0	3,80	■ ■



Schale „SLATE“

bowl
cuenco
bol



	cm	↑ cm	ltr.
84244	19 x 19	9	1,5
84245	25 x 25	12	3,8

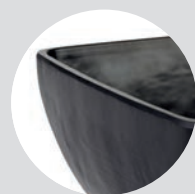

1:1 Oberflächenansicht
1:1 structural view



Deckel „PURE“ mit Löffelaussparung

cover with notched for spoons
tapa con espacio para la cuchara
couverture avec encoche pour la louche



	cm	↑ cm	fits to
83600	19 x 19	1,5	84409, 84417, 84422, 83409, 83468, 83572, 83573
83601	25 x 25	1,5	84408, 84418, 84423, 84430, 83575, 83574, 83469, 83408
83602	32 x 32	1,5	84425, 84427

Buffet & Tableware Melamin



Schale „PURE“

bowl
cuenco
bol



	cm	↑ cm	ltr.
83497	22,5 x 15,5	7,5	0,80
83498	38,5 x 15,5	7,5	1,50
83499	51,0 x 15,5	7,5	2,40



Tablett „SLATE“

tray
bandeja
plateau



	cm	↑ cm
84960	28 x 17,5	2,5
84961	Ø 28	2,5



GN Tablett „PURE GRANIT“

GN tray
GN bandeja
GN plateau



	cm	↑ cm	GN
84440	53,0 x 32,5	3	1/1
84441	32,5 x 26,5	3	1/2



Menage „PURE“

menage
conjunto aperitivo
set apéritif



4-teilig: 1 Ständer, Edelstahl matt poliert + 3 Melamin-Schalen, weiß (Nr. 83419)

4 pcs. set: 1 stainless stand satin polished finish + 3 white bowls (No. 83419)

set de 4: 1 soporte, acero inoxidable pulido mate + 3 cuencos de melamina blancos (ref. 83419)

set de 4: 1 support, acier inox poli mat + 3 bols de mélamine blancs (ref. 83419)

	cm	↑ cm
09924	14 x 14	16



Menage „PURE“

menage
conjunto aperitivo
set apéritif



5-teilig: 1 Ständer, Edelstahl matt poliert + 4 Melamin-Schalen, weiß (Nr. 83414)

5 pcs. set: 1 stainless stand satin polished finish + 4 square white bowls (No. 83414)

set de 5: 1 soporte, acero inoxidable pulido mate + 4 cuencos de melamina blancos (ref. 83414)

set de 5: 1 support, acier inox poli mat + 4 bols de mélamine blancs (ref. 83414)

	cm	↑ cm
09923	17 x 17	16



GN Tablett „FRAMES“

GN tray
GN bandeja
GN plateau



	cm	↑ cm	GN
84046	53,0 x 32,5	2	1/1
84047	32,5 x 26,5	2	1/2
84048	32,5 x 17,6	2	1/3



Schale / Pastateller „PURE“

bowl / pasta plate
cuenco / plato para pasta
bol / assiette creuse



	Ø cm	↑ cm	ltr.	Farbe / Colour
83412	32,0	7,5	1,5	White
83411	45,5	9,0	1,7	White



Tablett „MADE FOR PURE“

tray
bandeja
plateau



Edelstahl matt poliert, passend für Melamin-Schalen
stainless steel satin polished finish, for melamin bowls
acero inoxidable pulido mate, apta para cuencos de melamina
acier inox poli mat, pour bols de mélamine

	cm	
30120	20 x 11	für 2 Schalen / for 2 bowls para 2 cuencos / pour 2 bols
30121	29 x 20	für 6 Schalen / for 6 bowls para 6 cuencos / pour 6 bols

Schale „PURE COLOR“ / bowl / cuenco / bol

	cm	↑ cm	ltr.	Farbe / Colour
83414	9 x 9	4	0,14	White
83466	9 x 9	4	0,14	Black
83568	9 x 9	4	0,14	
83569	9 x 9	4	0,14	

Schale „PURE BICOLOR“ / bowl / cuenco / bol

	cm	↑ cm	ltr.	Farbe / Colour
84414	9 x 9	4	0,14	Black/White
84415	9 x 9	4	0,14	Green/White
84420	9 x 9	4	0,14	Grey/White



Blattschale „NATURAL COLLECTION“
leaf
fuente en forma de hoja
plateau feuille



	cm	↑ cm	Farbe / Colour
84083	40 x 18,5	3,5	White
84086	52 x 25,0	4,0	White
	cm	↑ cm	Farbe / Colour
84085	40 x 18,5	3,5	Green
84088	52 x 25,0	4,0	Green



Palmblattschale „NATURAL COLLECTION“
palm leaf
fuente en forma de hoja de palmera
plateau feuille de palme



	cm	↑ cm	litr.	Farbe / Colour
84080	40 x 18,5	10	1,8	White
84082	40 x 18,5	10	1,8	Green



stapelbar, mit Löffelablage
stackable, for spoons
apilable, práctico para cubiertos de servicio
empilable, pratique pour déposer les couverts



Blattschale „NATURAL COLLECTION“
leaf
fuente en forma de hoja
plateau feuille



	cm	↑ cm	Farbe / Colour
83864	34,5 x 8	2,5	White
83862	34,5 x 8	2,5	Green



Tablett „PINEAPPLE“

tray
bandeja
plateau



	cm	↑ cm	Farbe / Colour
84624	30 x 17	2,5	White



Palmblattschale „NATURAL COLLECTION“

palm leaf
fuente en forma de hoja de palmera
plateau feuille de palme



	Ø cm	↑ cm	ltr.	Farbe / Colour
83447	30	10,0	1,5	White
83896	35	12,5	4,5	White
	Ø cm	↑ cm	ltr.	Farbe / Colour
83449	30	10,0	1,5	Green
83894	35	12,5	4,5	Green



Blattschale „NATURAL COLLECTION“

leaf
fuente en forma de hoja
plateau feuille



	cm	↑ cm	Farbe / Colour
83435	36 x 16	3,0	White
83438	45 x 24	3,0	White
83441	53 x 29	3,5	White
	cm	↑ cm	Farbe / Colour
83437	36 x 16	3,0	Green
83440	45 x 24	3,0	Green
83443	53 x 29	3,5	Green



Palmblattschale „NATURAL COLLECTION“

palm leaf
fuente en forma de hoja de palmera
plateau feuille de palme



	cm	↑ cm	Farbe / Colour
83865	27 x 27	4,5	Green
83446	35 x 34	4,5	Green



Schale, oval „CLASSIC WAVE“

owl, oval
cuenco, ovalada
plateau ovale



	cm	↑ cm	ltr.	Farbe / Colour
83875	27 x 17	4,0	0,80	White
83876	34 x 21	4,5	1,30	White
83877	47 x 29	5,0	3,20	White



NEW ENAMEL LOOK

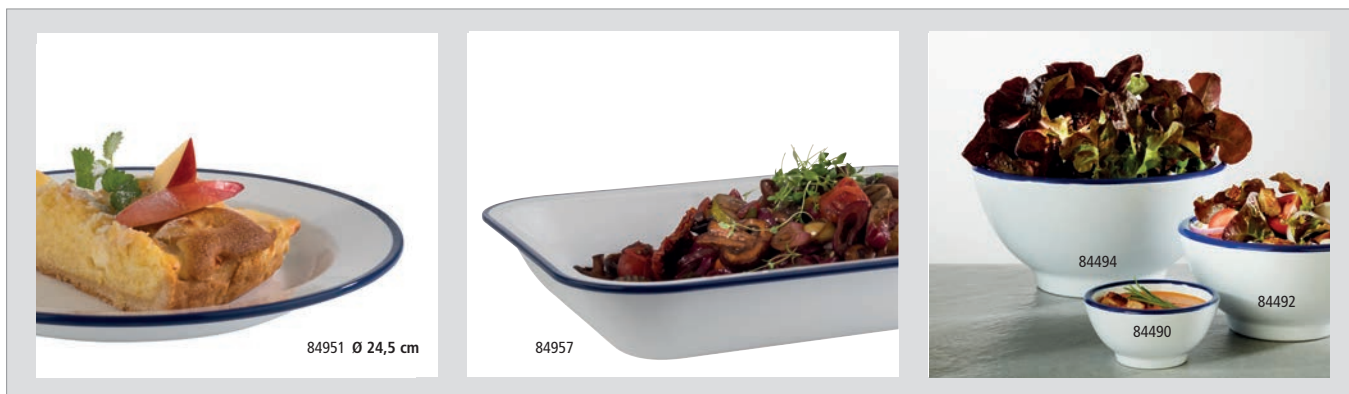

Suppenteller „ENAMEL LOOK“
 soup plate
 plato hondo
 assiette creuse



	Ø cm	↑ cm	Farbe / Colour
84952	19,0	3	
84953	22,5	4	
84954	24,5	4	



Schale „ENAMEL LOOK“
 bowl
 cuenco
 bol



	Ø cm	↑ cm	ltr.	Farbe / Colour
84490	5,5	4,0	0,02	
84491	9,5	4,5	0,09	
84492	13,0	6,5	0,30	
84493	15,0	7,5	0,45	
84494	20,0	10,5	1,25	



Schale „ENAMEL LOOK“

bowl
cuenco
bol



	cm	↑ cm	ltr.	Farbe / Colour
84955	15,5 x 11,5	3,5	0,25	
84956	17,5 x 13,0	4,5	0,30	

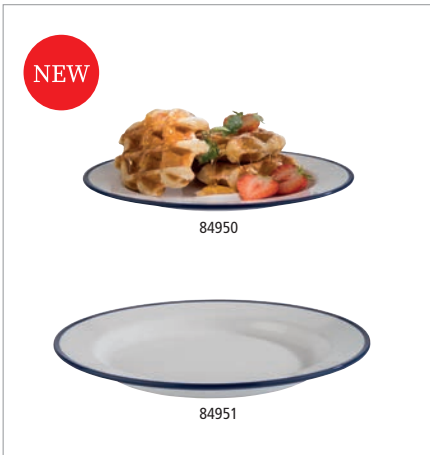

Teller „ENAMEL LOOK“

plate
plato
assiette



	Ø cm	↑ cm	Farbe / Colour
84950	20,5	2,0	
84951	24,5	2,5	



Schale „ENAMEL LOOK“

bowl
cuenco
bol



	cm	↑ cm	ltr.	Farbe / Colour
84958	15,0 x 11,5	6,5	0,30	
84959	21,5 x 16,5	9,5	1,00	



Schale „ENAMEL LOOK“

bowl
cuenco
bol



	cm	↑ cm	ltr.	Farbe / Colour
84957	29,0 x 23,5	5	1,5	



CASUAL



Schälchen „CASUAL MINI“

bowl
cuenco
bol mini



	cm	↑ cm	ltr.	Farbe / Colour
83880	6,0	2,5	0,02	White
83881	7,5	3,5	0,05	White



Schale „CASUAL MAXI“

bowl
cuenco
bol



	Ø cm	↑ cm	ltr.	Farbe / Colour
83696	10	4,5	0,15	White
83698	12	5,5	0,25	White
83700	14	6,5	0,50	White
83704	20	9,2	1,80	White
83702	23	10,5	2,50	White
.....				
	Ø cm	↑ cm	ltr.	Farbe / Colour
83697	10	4,5	0,15	Black
83699	12	5,5	0,25	Black
83701	14	6,5	0,50	Black
83705	20	9,2	1,80	Black
83703	23	10,5	2,50	Black

Deckel „FLOAT“ mit Löffelaussparung / cover, with notched for spoons / tapa, con espacio para la cuchara / couvercle, avec encoche pour la louche

	Ø cm	↑ cm	fits to
83920	20,5	1,3	83704, 83705



Dip-Schälchen „CASUAL“

dip bowl
cuenco para dip
ramequin



	Ø cm	↑ cm	ltr.	Farbe / Colour	VE / unit
83780	6,0	3,7	0,04	White	24
83781	7,0	3,7	0,05	White	24
83782	7,8	4,0	0,08	White	24
83783	8,5	4,5	0,11	White	24
83784	9,8	4,5	0,14	White	12
83798	6,0	3,7	0,04	Black	24
83777	6,0	3,5	0,03	Terracotta	24



Schale „SCANTIC“

bowl
cuenco
bol



	cm	↑ cm	ltr.
84221	26,5 x 10,5	6,5	1,0
84222	53,0 x 10,5	6,5	2,0



Schale „ORGANIC“

bowl
cuenco
bol



	cm	↑ cm	ltr.	Farbe / Colour
84235	32,5 x 17	5,5	1,0	White
84236	50,0 x 26	6,5	3,5	White



Schale „CASUAL“

bowl
cuenco
bol



	Ø cm	↑ cm	ltr.
84215	10	6,5 / 8,5	0,2
84216	12	7,5 / 9,5	0,3



Schale „TIERRA“

bowl
cuenco
bol



	Ø cm	↑ cm	ltr.	Farbe / Colour
84295	10	7	0,13	White



Dipschale „CASUAL“

dip tray
bandeja para dips
plateau pour dips



	cm	↑ cm
84220	29 x 9	3

NEW CLASSIC



Servier- und Tortenplatte „CLASSIC“

cake stand
porta pasteles
présentoir à gâteaux



Rand fixiert die Haube
carved edge fixes the cover
ranura para fijar bien la campana
bord rainuré pour maintenir ferme la cloche

	Ø cm	↑ cm
85049	21,5	9
85050	21,5	17
85051	30,5	9
85052	30,5	17
85053	37,5	9
85054	37,5	17

Frischhalte- Haube / cover / campana / cloche



	Ø cm	↑ cm	fits to
06519 NEW	21	17	85049, 85050
06520	30	22	85051, 85052
06521 NEW	36	27	85053, 85054

Frischhalte- Haube / cover / campana / cloche



	Ø cm	↑ cm	fits to
06512	30	11,5	85051, 85052



Torten- / Konditorplatte

cake stand
soporte para pastel
présentoir à gâteaux

Rand fixiert die Haube, mit Antirutsch-Füßchen

carved edge fixes the cover, with non-slip feet

ranura para fijar bien la campana, con pies antideslizantes

bord rainuré pour maintenir ferme la cloche, avec pieds antidérapants



	Ø cm	↑ cm	Farbe / Colour
00468	31	3,5	White
00469	31	3,5	Black



Torten- / Konditorplatte

cake stand
soporte para pastel
présentoir à gâteaux

Rand fixiert die Haube, mit Antirutsch-Füßchen

carved edge fixes the cover, with non-slip feet

ranura para fijar bien la campana, con pies antideslizantes

bord rainuré pour maintenir ferme la cloche, avec pieds antidérapants



	Ø cm	↑ cm
85044	21,5	2,5
00468	31,0	3,5
85045	37,5	4,0

Frischhalte- Haube / cover / campana/ cloche



	Ø cm	↑ cm	fits to
06519 NEW	21	17	85044
06520	30	22	00468
06521 NEW	36	27	85045



Servier- und Tortenplatte „CASUAL“

cake plate
porta pasteles
présentoir à gâteaux



	Ø cm	↑ cm
83890	31	8
83891	31	16



Servier- und Tortenplatte „CASUAL“

cake plate
porta pasteles
présentoir à gâteaux



	cm	↑ cm
83892	31 x 31	8
83893	31 x 31	16

Buffet & Tableware Melamin



Tablett / Teller „PURE“

tray / plate
bandeja / plato
plateau / assiette



	Ø cm	↑ cm	Farbe / Colour
83869	38	2,5	■

Rolltophaube / rolltop cover / campana abatible / cloche basculante

	Ø cm	↑ cm	
18388	38	20	mit verchromtem Kugelgriff / with chrome plated handle con pomo cromado / avec bouton chromé



Frischhalte-Haube

cover
campana
cloche



	Ø cm	↑ cm	
06510	30	11,5	
06512	30	11,5	mit verchromtem Griff / with chrom plated handle con botón cromado / avec bouton chromé



Schale „BALANCE“

bowl
cuenco
bol



	Ø cm	↑ cm	ltr.	Farbe / Colour
84040	14,5	9,0	0,4	■
84041	21,0	13,0	1,5	■
84042	24,5	15,0	2,5	■
84043	30,0	19,5	5,0	■

	Ø cm	↑ cm	ltr.	Farbe / Colour
85040	14,5	9,0	0,4	■
85041	21,0	13,0	1,5	■
85042	24,5	15,0	2,5	■
85043	30,0	19,5	5,0	■

Buffetständer „KING“ / buffet stand / soporte para buffet / présentoir buffet

	Ø cm	↑ cm
03622	15	14
03623	15	21



Besteckablage „SPOON“

cutlery rest
reposa cuchara
pose-cuillère



	cm	↑ cm	
83801	26 x 10,5	5	



Besteckablage „BOWL“

cutlery rest
reposa cuchara
pose-cuillère



	cm	↑ cm	ltr.
83803	22,5 x 11	6	0,5



Besteckablage „SMALL WAVE“

cutlery rest
reposa cuchara
pose-cuillère



	cm	↑ cm	
83897	26 x 13	4,5	



Teller mit Glashalter „COCKTAIL“

plate with glass holder
plato sujeta copas
assiette porte-verre



eignet sich besonders für Stehempfänge, einhändig nutzbar
particularly suitable for standing receptions, single-handed use
para uso en recepciones de pie, facil de usar con sólo una mano
particulièrement pour des receptions debout, utilisable avec une seule main

	cm	↑ cm	
84620	22 x 14	1,5	
84621	Ø cm	↑ cm	
	19	1,5	



Kaffeebecher „CASUAL“

coffee cup
taza de café
tasse à café



	Ø cm	↑ cm	ltr.
83513	9,5	10	0,4



Eierbecher, 4er Set

egg holder, 4 pcs. set
huevera, set de 4
coquetier, set de 4



	Ø cm	↑ cm	pcs.
83851	8	3	4
83848	8,5	2	4

FINGERFOOD LÖFFEL



Fingerfood Löffel „HALFTONE“
party spoon
cuchara party
cuillère party



	∅ cm	↑ cm	Farbe / Colour	VE / unit
84158	5,5	7	■ ■	24



Fingerfood Löffel „HALFTONE“
party spoon
cuchara party
cuillère party



	cm	↑ cm	Farbe / Colour	VE / unit
84128	14,5 x 4,5	4,5	■ ■	12



Fingerfood Löffel „BOAT“
party spoon
cuchara party
cuillère party



	cm	↑ cm	Farbe / Colour	VE / unit
84140	14,5 x 4,5	4,5	■ ■	32
84141	14,5 x 4,5	4,5	■ ■	32
84142	14,5 x 4,5	4,5	■ ■	12



Fingerfood Löffel „HONG KONG“

party spoon
cuchara party
cuillère party



	cm	↑ cm	Farbe / Colour	VE / unit
83486	13 x 4,5	4,5		60
83487	13 x 4,5	4,5		60
83424	13 x 4,5	4,5		60
83426	13 x 4,5	4,5		60



Fingerfood-Löffel „MING HING“

party spoon
cuchara party
cuillère party



	cm	↑ cm	Farbe / Colour	VE / unit
83842	11 x 4,5	4		60
83843	11 x 4,5	4		60



Fingerfood-Löffel „LEAF“

party spoon
cuchara party
cuillère party



	cm	↑ cm	Farbe / Colour	VE / unit
83889	10 x 4,5	1,5		50
83887	10 x 4,5	1,5		50
83888	10 x 4,5	1,5		50



MINI



84625

84626

84627

Schale „MINI COLOUR“

bowl
cuenco
bol



	cm	↑ cm	ltr.	Farbe / Colour	VE / unit
84625	12,5 x 9,0	3,5	0,02		12
84626	12,5 x 9,0	3,5	0,02		12
84627	12,5 x 9,0	3,5	0,02		12

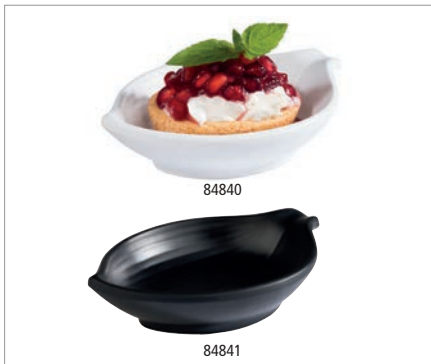

84840

84841

Schale „MINI LEAF“

bowl
cuenco
bol



	cm	↑ cm	ltr.	Farbe / Colour	VE / unit
84840	10,5 x 7,5	2,5	0,04		40
84841	10,5 x 7,5	2,5	0,04		40



84842

84843

Schale „MINI LEAF“

bowl
cuenco
bol



	cm	↑ cm	ltr.	Farbe / Colour	VE / unit
84842	10,5 x 6,5	4,5	0,06		40
84843	10,5 x 6,5	4,5	0,06		40



84844

84845

Schale „MINI LEAF“

bowl
cuenco
bol



	cm	↑ cm	ltr.	Farbe / Colour	VE / unit
84844	14,5 x 6,0	3,0	0,05		40
84845	14,5 x 6,0	3,0	0,05		40



Schale „MINI“

bowl
cuenco
bol



	cm	↑ cm	ltr.	Farbe / Colour	VE / unit
84750	8 x 8	3	0,06		24
84760	8 x 8	3	0,06		24

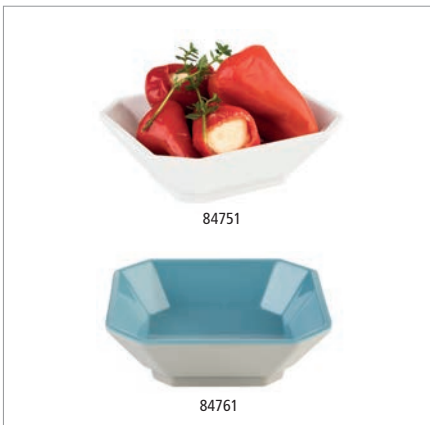

Schale „MINI“

bowl
cuenco
bol



	cm	↑ cm	ltr.	Farbe / Colour	VE / unit
84751	9,5 x 9,5	3	0,1		24
84761	9,5 x 9,5	3	0,1		24



Schale „MINI“

bowl
cuenco
bol



	cm	↑ cm	ltr.	Farbe / Colour	VE / unit
84752	9,5 x 8	3	0,08		24
84762	9,5 x 8	3	0,08		24



Schale / Schiffchen „MINI“

bowl
cuenco
bol



	cm	↑ cm	ltr.	Farbe / Colour	VE / unit
84753	12,5 x 5,5	4	0,06		24
84763	12,5 x 5,5	4	0,06		24



Schale / Schiffchen „MINI“

bowl
cuenco
bol



	cm	↑ cm	ltr.	Farbe / Colour	VE / unit
84754	14 x 6,5	4	0,1		24
84764	14 x 6,5	4	0,1		24

Buffet & Tableware Melamin



Teller „MINI“
plate
plato
assiette



	cm	↑ cm	ltr.	VE / unit
84444	10,5 x 8,5	2,0	0,07	20



Schale „MINI“
bowl
cuenco
bol



	cm	↑ cm	ltr.	VE / unit
84445	10,5 x 6,0	4,0	0,07	20
84446	13,5 x 7,5	3,0	0,07	20
84448	9,5 x 9,0	5,5	0,09	20
84449	13,0 x 12,0	7,5	0,18	20



Schale „MINI“
bowl
cuenco
bol



	Ø cm	↑ cm	ltr.	Farbe / Colour
84775	8,5	2,5	0,07	White
84778	8,5	2,5	0,07	Black
84781	8,5	2,5	0,07	Dark Grey



Schale „MINI“
bowl
cuenco
bol



	Ø cm	↑ cm	ltr.	Farbe / Colour
84776	8,5	2,5	0,07	White
84779	8,5	2,5	0,07	Black
84782	8,5	2,5	0,07	Dark Grey



Schale „MINI“
bowl
cuenco
bol



	cm	↑ cm	ltr.	Farbe / Colour
84777	9,5 x 5,5	5,5	0,07	White
84780	9,5 x 5,5	5,5	0,07	Black
84783	9,5 x 5,5	5,5	0,07	Dark Grey



Schale „MINI“

bowl
cuenco
bol



	cm	↑ cm	ltr.	VE / unit
84452	11,5 x 7,5	3,0	0,06	24
84454	11,5 x 6,0	5,5	0,04	24
84456	8,5 x 7,0	6,0	0,07	24
84458	8,0 x 8,0	4,0	0,10	24
84450	7,5 x 7,0	4,5	0,05	24

Schälchen „GOURMET“ / bowl / cuenco / bol

	Ø cm	↑ cm	ltr.
84018	7	6	0,05



Schale „HALFTONE“

bowl
cuenco
bol



	Ø cm	↑ cm	ltr.	VE / unit
84217	8,0	4,0	0,1	12
84218	8,5	3,5	0,05	12



Schale „MINI“

bowl
cuenco
bol



	cm	↑ cm	ltr.	VE / unit
84460	35 x 4,5	3	0,20	10



Tablett „GOURMET“

tray
bandeja
plateau



mit 3 Absätzen Ø 4 cm
with 3 holes Ø 4 cm
con 3 agujeros Ø 4 cm
avec 3 trous Ø 4 cm

	cm	↑ cm
84017	30,5 x 9,5	2,5

Schälchen „GOURMET“ / bowl / cuenco / bol

	Ø cm	↑ cm	ltr.
84018	7	6	0,05





Tableware Table Presentation

Tableware
Table Presentation

Schalen
Teller
Mühlen
Leuchter
Tischsets

cuencos
bandejas
molinillos
candelabros
mantelinas

bowls
trays
mills
candle holders
placemats

bols
plateaux
moulins
chandeliers
sets de table



NEW

Servierkelle - *super trendy*



40680

40681

Servierkelle „BOB“

serving trowel
paleta para servir
truelle de service

EDELSTAHL
STAINLESS
INOX

HOLZ
WOOD



Edelstahl Servierkelle mit schwarzem Holzgriff

stainless steel serving trowel with black wooden handle
paleta para servir de acero inoxidable con mango de madera negra
truelle de service en acier inox avec manche en bois noir

	cm	↑ cm	Griff	
40680	23,5 x 15,5	12,5	13,5	stainless steel
40681	23,5 x 15,5	12,5	13,5	■



NEW

40675

40676

Snackbox „INDUSTRIAL“

snack box
caja tentempié
casse-croûte

METALL



Metall, schwarz

metal, black
metal, negro
métal, noir

	cm	↑ cm	ltr.
40675	16,5 x 10,5	7,50	0,5
40676	23,0 x 15,5	13,0	2,4



stapelbar
stackable

NEW



30130



30131



30132



30132



30133



30133

Tablett „VINTAGE“

tray
bandeja
plateau



Edelstahl-Look vintage
stainless steel vintage look
acero inoxidable look vintage
acier inox look vintage

	cm	↑ cm
30130	26,0 x 13,5	1,5
30131	34,0 x 18,0	1,5
30132	38,0 x 26,5	1,5
30133	25,5 x 16,0	3,0



passende Schälchen / fitting bowls / cuencos adecuados / bols apropiés

	Ø cm	↑ cm	ltr.
40655	7,5	5,5	0,17
40656	7,5	10,0	0,35



S. 276
page 276

40656

40655



30130



30132

Servierbeispiel
serving example

passendes Wachspapier / greaseproof paper squares / papel alimenticio para cucurucho / papier alimentaire pour cornet

	cm	pcs.	
40670	42 x 25	500	Motiv: Zeitung
40671	42 x 25	500	blank
40672	42 x 25	500	Motiv: rote Karos / red
40673	42 x 25	500	Motiv: blaue Karos / blue
40674	30 x 20	500	Motiv: Fast Food / black



40672

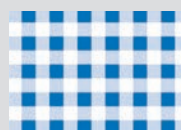

40673



40674

Tablett „TREND“

baking sheet
bandeja
plateau



ein Backblech wird zum Serviertablett
a baking sheet which becomes a serving tray
una bandeja de hornear que se convierte en una bandeja de servir
un moule qui devient un plateau de service

	cm	↑ cm
13380	32 x 21,5	2



40672



NEW **CAST IRON**

Die Servierpfännchen aus emailliertem Gußeisen dienen dem portionsweisen Servieren und halten die Speisen warm.

The serving pans made of enameled cast iron are used for serving in portions and for keeping the food warm.

Las fuentes de hierro fundido esmaltado se utilizan para servir en porciones y mantener la comida caliente.

Les plateaux de service en fonte émaillée sont utilisés pour servir en portions et garder les aliments au chaud.

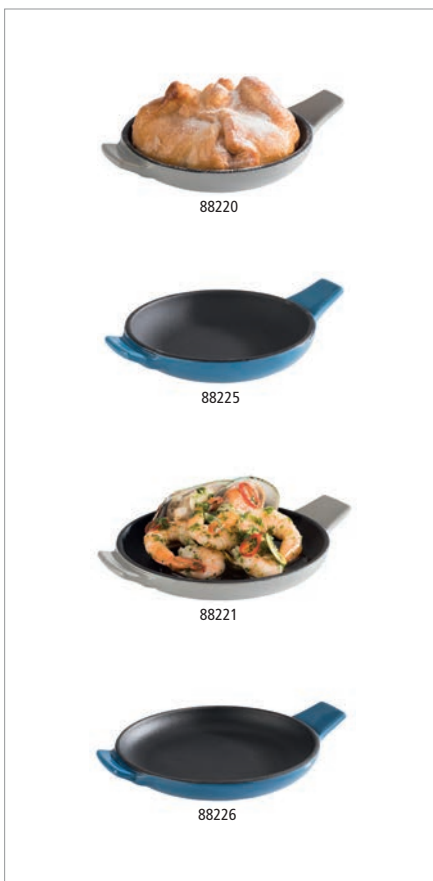

Servierpfännchen „CAST IRON“
 serving pan
 fuente para servir
 plat de service



Gusseisen emailliert
 enameled cast iron
 hierro fundido esmaltado
 fonte émaillée

	Ø cm	↑ cm	Farbe / Colour
88220	10	2	
88225	10	2	
88221	13	2	
88226	13	2	



stapelbar
 stackable

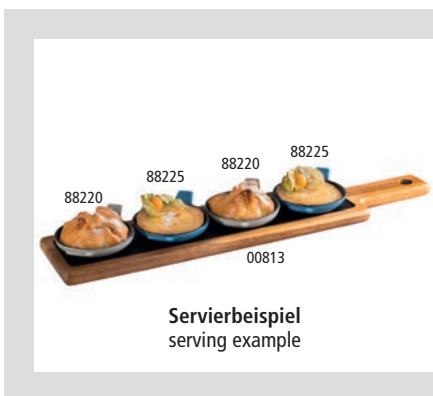



Servierpfännchen „CAST IRON“

servicing pan
fuente para servir
plat de service



Gusseisen emailliert
enamelled cast iron
hierro fundido esmaltado
fonte émaillée

	cm	↑ cm	Farbe / Colour
88222	13 x 13	2	Grey
88227	13 x 13	2	Blue
88223	16 x 13	2	Grey
88228	16 x 13	2	Blue
88224	20 x 13	2	Grey
88229	20 x 13	2	Blue



Präsentationsmöglichkeit
presentation example

HOLZ WOOD
Genusspalette im Kleinformat, Birke / mini serving palett, birch / tabla de servir, formato pequeño, abedul / planche de service, petit format, bouleau

	cm	↑ cm	fits to
00880	20 x 12	3	88223, 88228

HOLZ WOOD
Buffetständer „ACACIA“, Akazienholz geölt / buffet stand, acacia wood oiled / soporte para buffet, madera de acacia aceitada / présentoir buffet, bois d'acacia huilé

	cm	↑ cm	GN
15623	53 x 16,2	20	2/4



SNACKHOLDER



Die Mini-Edestahlkörbchen dienen dem portionsweisen Servieren. Zum originellen Servieren von Beilagen geeignet, aber auch zum Frittieren selbst.

The mini frying baskets are used to present individual portions in an original way, but can still be used to fry.

Las cestas de freir ofrecen una presentación original para el servicio de tapas o raciones individuales de patatas, aperitivos, fritos, etc.

Les paniers à friture offrent une présentation originale pour servir apéritifs, snacks, tapas et autres rations individuelles. Également aptes pour frire.



Servier-Frittierkorb „SNACKHOLDER“

stainless steel fry baskets
cestitas inox para el servicio mesa
paniers inox pour le service sur table



	Ø cm	↑ cm	Griff
40600	8	7,5	9,5
40601	9	8,5	9,0



Servier-Frittierkorb „SNACKHOLDER“

stainless steel fry baskets
cestitas inox para el servicio mesa
paniers inox pour le service sur table



	cm	↑ cm	Griff
40610	21,5 x 10,5	4,5	9,5
40611	26,0 x 13,0	5,0	9,0



Servier-Frittierkorb „SNACKHOLDER“

stainless steel fry baskets
cestitas inox para el servicio mesa
paniers inox pour le service sur table



	cm	↑ cm	Griff
40620	10,0 x 8,5	6,5	9,0
40621	13,0 x 10,5	9,0	13,5

SNACKHOLDER



Made from PVD coated stainless steel

Die Mini-Edestahlkörbchen dienen dem portionsweisen Servieren. Zum originellen Servieren von Beilagen geeignet, aber auch zum Frittieren selbst.

The mini frying baskets are used to present individual portions in an original way, but can still be used to fry.

Las cestas de freir ofrecen una presentación original para el servicio de tapas o raciones individuales de patatas, aperitivos, fritos, etc.

Les paniers à friture offrent une présentation originale pour servir apéritifs, snacks, tapas et autres rations individuelles. Également aptes pour frire.



40602

Servier-Frittierkorb „SNACKHOLDER“

stainless steel fry baskets
cestitas inox para el servicio mesa
paniers inox pour le service sur table



	Ø cm	↑ cm	Griff	Farbe / Colour
40602	8	7,5	9,5	—
40603	9	8,5	9,0	—



40613

Servier-Frittierkorb „SNACKHOLDER“

stainless steel fry baskets
cestitas inox para el servicio mesa
paniers inox pour le service sur table



	cm	↑ cm	Griff	Farbe / Colour
40612	21,5 x 10,5	4,5	9,5	—
40613	26,0 x 13,0	5	9,5	—



40622

Servier-Frittierkorb „SNACKHOLDER“

stainless steel fry baskets
cestitas inox para el servicio mesa
paniers inox pour le service sur table



	cm	↑ cm	Griff	Farbe / Colour
40622	10,0 x 8,5	6,5	9,0	—
40623	13,0 x 10,5	9,0	13,5	—

Tableware . Table Presentation



Snackholder

serving cup
vaso para servir
gobelet à apéritif



Edelstahl, außen verkupfert

stainless steel, outside copper coated
acero inoxidable, el exterior está cubierto de cobre
acier inoxydable, l'extérieur est cuivré

	Ø cm	↑ cm	ltr.	Farbe / Colour	
40616	9,5	8,5 / 11,5	0,45		kupfer / copper
40617	8,5	8,5	0,35		kupfer / copper
40618	8,5	8,5	0,35		gehämmerte Oberfläche / hammered



Snackholder

serving cup
vaso para servir
gobelet à apéritif



	Ø cm	↑ cm	ltr.	
40605	9,5	8,5 / 11,5	0,45	
40606	8,5	8,5	0,35	
40607	8,5	8,5	0,35	gehämmerte Oberfläche / hammered



Servier- / Saucen-Eimer „SNACKHOLDER“

mini stainless steel bucket
cubo inox en formato mini
seau mini inox



	Ø cm	↑ cm	ltr.	pcs.
40630	7	6,5	0,15	4
40631	9	8,5	0,33	1

NEW



40675

Snackbox „INDUSTRIAL“

snack box
caja tentempié
casse-croûte

Metall, schwarz

metal, black
metal, negro
métal, noir



	cm	↑ cm	ltr.
40675	16,5 x 10,5	7,5	0,5
40676	13,0 x 10,5	9,0	2,4



4 pcs. set

Mini-Milchkanne „SNACKHOLDER“

mini milk can
lechera en formato mini
pot à lait mini



	∅ cm	↑ cm	ltr.	pcs.
40640	4,5	5	0,08	4



Mini-Servierpfanne „SNACKHOLDER“

mini pan
sartén en formato mini
poêle à frire mini



	cm	↑ cm	ltr.
40660	14,5 x 9,5	4,5 / 6,5	0,5

40671



40670

Wachspapier „SNACKHOLDER“

greaseproof paper squares
papel alimenticio para cucurucho
papier alimentaire pour cornet

	cm	pcs.	
40670	42 x 25	500	Motiv: Zeitung
40671	42 x 25	500	blank

	cm	pcs.	
40672	42 x 25	500	Motiv: rote Karos / red
40673	42 x 25	500	Motiv: blaue Karos / blue
40674	30 x 20	500	Motiv: Fast Food / black



40672



40673



40674

40674

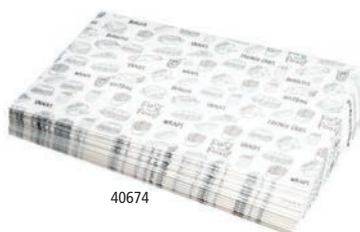

Tableware . Table Presentation

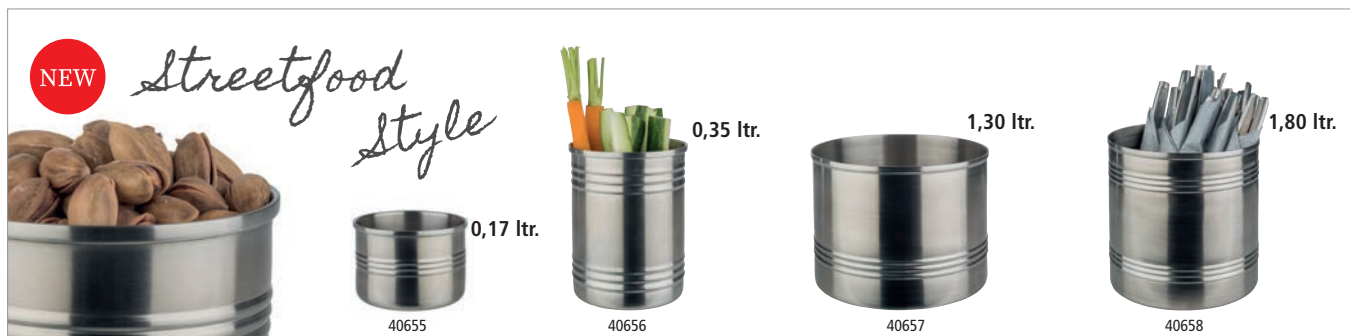

Snackcan
serving can
bote para aperitivos
boîte pour apéritifs



	Ø cm	↑ cm	ltr.
40655	7,5	5,5	0,17
40656	7,5	10,0	0,35
40657	13,5	10,5	1,30
40658	13,5	14,0	1,80



Schale
bowl
cuenco
bol



	Ø cm	↑ cm	ltr.
40685	6	3,0	0,05
40686	8	4,5	0,17

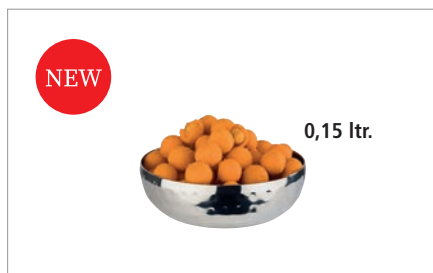

Schale
bowl
cuenco
bol



gehämmerte Oberfläche / hammered surface / superficie martillada / surface martelée

	Ø cm	↑ cm	ltr.
40185	9,5	3	0,15



Serviertöpfchen
small serving pot
olla pequeña de servir
marmite petite de servir



gehämmerte Oberfläche
hammered surface
superficie martillada
surface martelée

	Ø cm	↑ cm	ltr.	Griff / handle
40186	9,5	5,5	0,30	2,5
40187	13,5	5,0	0,55	3,0
40188	15,5	5,0	0,75	3,0



Schale

bowl
cuenco
bol



gehämmerte Oberfläche
hammered surface
superficie martillada
surface martelée

	cm	↑ cm	ltr.	Farbe / Colour
40690	15,5 x 12,0	5,5	0,7	gold look
40693	23,0 x 15,5	6,0	1,4	gold look



Schale

bowl
cuenco
bol



gehämmerte Oberfläche
hammered surface
superficie martillada
surface martelée

	cm	↑ cm	ltr.	Farbe / Colour
40691	15,5 x 12,0	5,5	0,7	copper look
40694	23,0 x 15,5	6,0	1,4	copper look



Schale

bowl
cuenco
bol



gehämmerte Oberfläche
hammered surface
superficie martillada
surface martelée

	cm	↑ cm	ltr.	Farbe / Colour
40692	15,5 x 12,0	5,5	0,7	gunmetal-look
40695	23,0 x 15,5	6,0	1,4	gunmetal-look

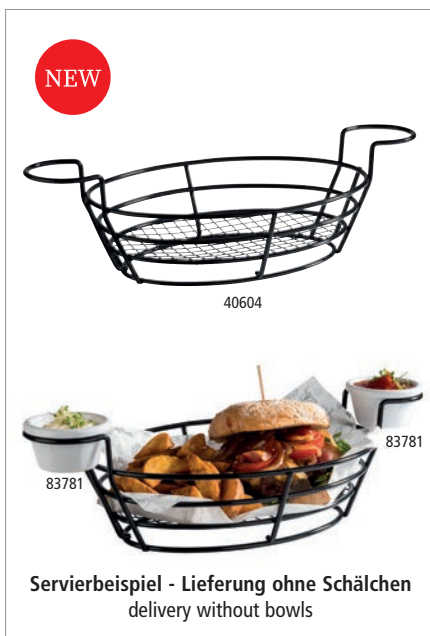

Servierkorb „BURGER & FRIES“

serving basket
cesta para servir
corbeille de service



Servierkorb aus Metall mit 2 Halter für Dipschälchen

metal serving basket with 2 holders for dip bowls

cesta de metal para servir con 2 soportes para cuencos para dip

corbeille de service en métal avec 2 supports pour ramequins

	cm	↑ cm
40604	39,5 x 20	11

passende Schälchen / fitting bowls / cuencos adecuados / bols apropiés



	ø cm	↑ cm	ltr.	VE / unit
83781	7	3,7	0,05	24

Servierbeispiel - Lieferung ohne Schälchen
delivery without bowls

ENAMELWARE



40664

Teller „ENAMELWARE“

plate
plato
assiette



	Ø cm	↑ cm	Farbe / Colour	
40664	20	2		flacher Teller
40665	24	2		flacher Teller
40666	26	2		flacher Teller



40662

Teller „ENAMELWARE“

plate
plato
assiette



	Ø cm	↑ cm	Farbe / Colour	
40661	18	3,5		tiefer Teller
40662	22	3,5		tiefer Teller
40663	24	3,5		tiefer Teller



40668

Schale „ENAMELWARE“

bowl
cuenco
bol



	cm	↑ cm	ltr.	Farbe / Colour
40667	16 x 12,0	3,5	0,20	
40668	18 x 13,5	4,0	0,35	



Schale „ENAMELWARE“

bowl
cuenco
bol



	cm	↑ cm	ltr.	Farbe / Colour
40669	28 x 23	4,5	1,9	



Henkelbecher „ENAMELWARE“

beaker
vaso coctelero
bol mélangeur



	Ø cm	↑ cm	ltr.	Farbe / Colour
40636	7	5	0,10	
40632	9	8	0,35	
40637	10	9	0,50	



Henkelbecher „ENAMELWARE“

beaker
vaso coctelero
bol mélangeur



	Ø cm	↑ cm	ltr.	Farbe / Colour
40633	9	8	0,35	



Henkelbecher „ENAMELWARE“

beaker
vaso coctelero
bol mélangeur



	Ø cm	↑ cm	ltr.	Farbe / Colour
40634	9	8	0,35	



Henkelbecher „ENAMELWARE“

beaker
vaso coctelero
bol mélangeur



	Ø cm	↑ cm	ltr.	Farbe / Colour
40635	9	8	0,35	



Schale „ENAMELWARE“

bowl
cuenco
bol



	Ø cm	↑ cm	ltr.	Farbe / Colour
40645	7,0	4,5	0,08	
40646	8,0	3,5	0,08	
40638	13,0	6,0	0,50	
40647	16,5	4,5	0,45	



Weck-Flaschen, 6er Set

Weck-bottles
Weck-botellas
Weck-bouteilles



6 Flaschen + 6 Deckel, ideal zum Servieren von Saft, Smoothie, Dressing und Saucen
6 bottles + 6 covers, ideal for serving juice, smoothie, dressing and sauces
6 botellas + 6 tapas, ideal para servir zumo, licuado, aliño y salsas
6 bouteilles + 6 couvercles, idéal pour servir de jus, smoothie, vinaigrette et sauces

	Ø cm	↑ cm	ltr.	pcs
82307	6	14,5	0,25	6



Weck-Flaschen, 6er Set

Weck-bottles
Weck-botellas
Weck-bouteilles



6 Flaschen + 6 Deckel, ideal zum Servieren von Saft, Smoothie, Dressing und Saucen
6 bottles + 6 covers, ideal for serving juice, smoothie, dressing and sauces
6 botellas + 6 tapas, ideal para servir zumo, licuado, aliño y salsas
6 bouteilles + 6 couvercles, idéal pour servir de jus, smoothie, vinaigrette et sauces

	Ø cm	↑ cm	ltr.	pcs
82308	6	19	0,5	6



Weck-Flaschen, 6er Set

Weck-bottles
Weck-botellas
Weck-bouteilles



6 Flaschen + 6 Deckel, ideal zum Servieren von Saft, Smoothie, Dressing und Saucen
6 bottles + 6 covers, ideal for serving juice, smoothie, dressing and sauces
6 botellas + 6 tapas, ideal para servir zumo, licuado, aliño y salsas
6 bouteilles + 6 couvercles, idéal pour servir de jus, smoothie, vinaigrette et sauces

	Ø cm	↑ cm	ltr.	pcs
82309	6	25,5	1,0	6



Weck-Gläser mit Deckel, 12er Set

Weck-glasses with lid
Weck tarros de vidrio con tapa
Weck verrines avec couvercle



12 Gläser + 12 Deckel
12 glasses + 12 covers
12 vasos + 12 tapas
12 verrines + 12 couvercles

	Ø cm	↑ cm	ltr.	pcs
82316	7	8,0	0,22	12



Weck-Gläser mit Deckel, 12er Set

Weck-glasses with lid
Weck tarros de vidrio con tapa
Weck pots en verre avec couvercle



12 Gläser + 12 Deckel
12 glasses + 12 cover
12 vasos + 12 tapas
12 verrines + 12 couvercles

	Ø cm	↑ cm	ltr.	pcs
82345	9	6	0,20	12



Weck-Gläser mit Deckel, 3er Set

Weck-glasses with lid, 3 pcs.
Weck tarros de vidrio con tapa, set de 3
Weck verrines avec couvercle, set de 3



3 Gläser + 3 Deckel
3 glasses + 3 covers
3 vasos + 3 tapas
3 verrines + 3 couvercles

	Ø cm	↑ cm	ltr.	pcs
82346	11	7,5	0,37	3



Weck-Gläser mit Deckel, 2er Set

Weck-glasses with lid, 2 pcs.
Weck tarros de vidrio con tapa, set de 2
Weck verrines avec couvercle, set de 2



2 Gläser + 2 Deckel
2 glasses + 2 covers
2 vasos + 2 tapas
2 verrines + 2 couvercles

	Ø cm	↑ cm	ltr.	pcs
82347	11	11	0,58	2

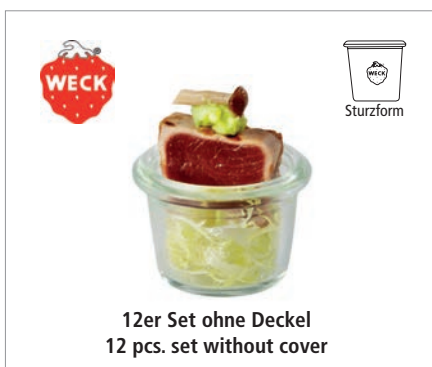

Gourmetgläser, 12er Set

gourmet glasses, 12 pcs.
tarros gourmet, set de 12
verres gourmet, set de 12



	Ø cm	↑ cm	ltr.	pcs
82359	5	3,5	0,035	12
82370	6	5,5	0,08	12
82371	6	8,0	0,16	12

12er Set ohne Deckel
12 pcs. set without cover



Weck-Gläser mit Deckel, 12er Set

Weck-glasses with lid
Weck tarros de vidrio con tapa
Weck verrines avec couvercle



12 Gläser + 12 Deckel
12 glasses + 12 covers
12 vasos + 12 tapas
12 verrines + 12 couvercles

	Ø cm	↑ cm	ltr.	pcs
82310	6	5,5	0,08	12
82312	6	7,0	0,14	12
82314	6	8,0	0,16	12



Serviergestell „WECK“

serving stand
expositor
présentoir



ohne Gläser
without glasses
sin vasos
sans verrines

	Ø cm	↑ cm	
33246	22	59	12 x Ø 6 cm



Serviergestell „WECK“

serving stand
expositor
présentoir



ohne Gläser
without glasses
sin vasos
sans verrines

	Ø cm	↑ cm	
33247	22	33	6 x Ø 6 cm



Weck-Frischhaltedeckel, 5er Set

airtight cover, 5 pcs.
tapa hermética, set de 5
couvercle hermétique, set de 5



für Rundrandgläser Ø 6 cm, 5er Set

for Ø 6 cm glasses, 5 pcs. set
para vasos Ø 6 cm, set de 5
pour verrines Ø 6 cm, set de 5

	Ø cm	pcs
82338	7	5



10er Set Gummidichringe

10 pcs. rubber washer
10 juntas de goma
10 joints de caoutchouc

für Deckel der Weck-Gläser, im Beutel verpackt

for covers of Weck-glasses
para las tapas de los tarritos Weck
pour la fermeture des verrines Weck

	fits to
82318	82307, 82308, 82309, 82310, 82312, 82314, 82316
82394	82345
82395	82346, 82347



8er Set Deckel-Klammer für 4 Weck-Gläser

8 pcs. cover clamps for 4 Weck-glasses
8 abrazaderas para 4 vasitos Weck
8 agrafes pour 4 verrines Weck



82319



Topf darf nicht erhitzt werden!
Topf ist nicht zum Kochen geeignet!

Muscheltopf

mussel pot
mejillonera
casserole à moules

schwarz emailliertes Stahlblech, mit Edelstahlrand

black enamelled steel, stainless steel rim

hierro esmaltado negro, borde inox

acier émaillé noir, bord inox



	Ø cm	↑ cm	Topf / pot ltr.	Deckel / lid ltr.
00623	13,5	9,0	0,75	0,60
00625	18,0	12,0	2,60	1,40
00626	20,0	13,0	3,30	1,60
00627	24,0	13,5	5,20	2,70

Tableware . Table Presentation



Schale „OLIVE“

bowl
cuenco
bol

aus geöltem Olivenholz
oiled olive wood
de madera de olivo aceitada
en bois d'olivier huilé



	cm	↑ cm	ltr.
00843	12,0 x 7,5	2,5	0,05
00844	16,5 x 9,5	2,5	0,10



Schale „OLIVE“

bowl
cuenco
bol

aus geöltem Olivenholz
oiled olive wood
de madera de olivo aceitada
en bois d'olivier huilé



	cm	↑ cm	ltr.
00907	13 x 8	6,5	0,20
00908	16 x 9	7,0	0,30



Servierbrett „OLIVE“

serving board
tabla de servir
planche de service

aus geöltem Olivenholz
oiled olive wood
de madera de olivo aceitada
en bois d'olivier huilé



	cm	↑ cm
00905	25,5 x 16,5	1,5
00906	35,0 x 20,5	1,5



Servierbrett „NARROW“

serving board
tabla de servir
planche de service

Akazienholz, mit 3 Vertiefungen Ø 6 cm
acacia wood, with 3 notches Ø 6 cm
madera de acacia, con 3 ranuras Ø 6 cm
bois d'acacia, avec 3 encoches Ø 6 cm



	cm	↑ cm
00878	31 x 11	2



passende Schälchen / fitting bowls / cuencos adecuados / bols apropiés

	Ø cm	↑ cm	ltr.	
40685	6	3	0,05	stainless steel
82316	7	8	0,22	glas

NEW



Servierbrett „SHARING“

serving board
tabla de servir
planche de service



Servierbrett aus geöltem Akazienholz
serving board made of oiled acacia wood
tabla de servir de madera de acacia aceitada
planche en bois d'acacia huilé

	cm	↑ cm	Griff / handle cm
00887	51,5 x 18	1,5	8,5



00868

Servierbrett „AKAZIE-SCHIEFER“

serving board
tabla de servir
planche de service

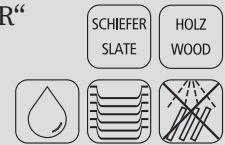

raffiniertes, rustikales Servierbrett
aus Akazienholz, ausgestattet mit einem Naturschieferstreifen
zur Kennzeichnung

wood with slate, markable
madera con pizarra, se puede marcar
bois avec ardoise, on peut mettre une inscription

	cm	↑ cm
00867	30,5 x 13	1,5
00868	36,5 x 15	1,5
00869	42,0 x 18	1,5



00870



00873



00875

Servierbrett „OLIVE“

serving board
tabla de servir en madera de olivo
planche de service en bois d'olivier



Servierbrett im Naturschnitt, aus Olivenholz. Jedes Brett wird handgefertigt und geölt mit 19 mm Aufhäng Bohrung. Alle Produkte unterscheiden sich naturbedingt in Form, Maserung und Größe!

Olive Wood is known for its versatility and striking appearance with each piece having its own unique features.

El olivo es conocido por su versatilidad y aspecto espectacular y único en cada pieza. Por su fabricación a mano de forma artesanal, todas las piezas varían en tamaño, forma y acabado, lo que hace de cada una un ejemplar único.

Le bois d'olivier est reconnu pour sa versatilité et son esthétique spectaculaire. De par leur fabrication artisanale à la main, toutes les pièces varient quant à leur taille, forme et finition, de telle sorte que chacune est un exemplaire unique.

	cm	↑ cm	Griff / handle cm
00870	25,0 x 17,0	1,5	
00871	30,0 x 20,5	2,0	
00872	35,0 x 24,0	2,0	
00873	40,0 x 15,0	1,5	11
00874	44,0 x 20,0	2,0	12
00875	19,0 x 12,5	1,5	6
00876	25,0 x 16,0	1,5	8
00877	31,0 x 20,0	1,5	9

Tableware . Table Presentation

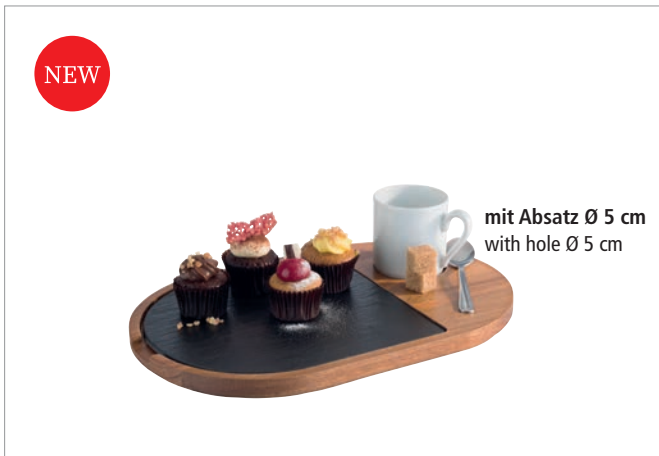

Servierbrett, 2-tlg.
serving board, 2 pcs. set
tabla de servir, set de 2
planche de service, set de 2

SCHIEFER
SLATE

HOLZ
WOOD



2-teilig:
1 Holzbrett aus Akazienholz + 1 Naturschieferplatte
1 wood board made of acacia wood + 1 natural slate tray
1 tabla de madera de acacia + 1 pizarra natural
1 planche en bois d'acacia + 1 ardoise naturelle

	cm	↑ cm
00814	28 x 17,5	2

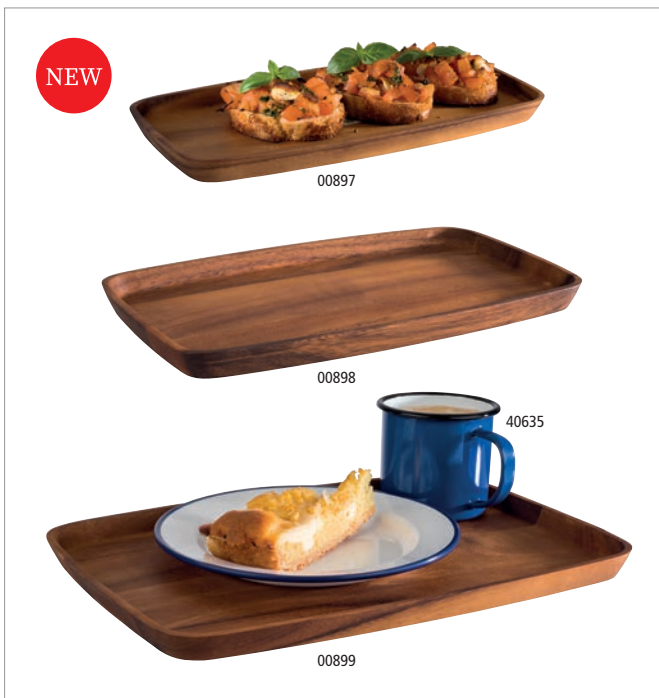

Servierbrett
serving board
tabla de servir
planche de service



Servierbrett aus geöltem Akazienholz
serving board made of oiled acacia wood
tabla de servir de madera de acacia aceitada
planche en bois avec plateau en bois d'acacia huilé

	cm	↑ cm
00897	30 x 15	2
00898	30 x 18	2
00899	35 x 25	2



Servierbrett, 2-tlg.
serving board, 2 pcs. set
tabla de servir, set de 2
planche de service, set de 2

SCHIEFER
SLATE

HOLZ
WOOD



2-teilig:
Ein rustikales Servierbrett aus Akazienholz,
ausgestattet mit einer Naturschieferplatte
wood board oiled acacia with a slate tray
tabla de madera de acacia con una bandeja de pizarra natural
planche en bois d'acacia avec un plateau en ardoise naturelle

	cm	↑ cm
00810	26 x 18	2
00811	33 x 20	2
00812	40 x 15	2
00813	43 x 12	2

Präsentationsmöglichkeit
presentation example



mit Hängeloch Ø 2 cm / with a handle-hole Ø 2 cm



Servierbrett „OAK“

serving board
tabla de servir
planche de service



aus geöltem Eichenholz, Safrille, ø 9,5 cm runde Aussparung
made of oiled oak, with juice groove, with hole ø 9,5 cm
de madera de roble aceitada, con ranura para líquidos, con agujero ø 9,5 cm
en bois chêne huilé, avec rigole, avec trou ø 9,5 cm

	cm	↑ cm
00808	37 x 25	2



mit Safrinne / with juice groove



Holzbox „TABLE“

woodbox
caja madera
base bois



Akazienholz, 3 Fächer (6,5 x 6,5 cm)
acacia wood, 3 compartments (6,5 x 6,5 cm)
madera de acacia, 3 compartimentos (6,5 x 6,5 cm)
bois d'acacia, 3 compartiments (6,5 x 6,5 cm)

	cm	↑ cm	inner size cm
11727	23,5 x 8,5	4,5	6,5 x 6,5 je Fach / each compartment



Holzbox „VINTAGE“

woodbox
caja madera
base bois



Akazienholz, vintage weiß
acacia wood, vintage white
madera de acacia, blanca vintage
bois d'acacia, blanc vintage

	cm	↑ cm	inner size cm
11725	15 x 9,5	5	12 x 6,5



Holzbox „TABLE“

woodbox
caja madera
base bois



Akazienholz, natur
acacia wood, nature
madera de acacia, natural
bois d'acacia, naturel

	cm	↑ cm	inner size cm
11726	15 x 9,5	5	12 x 6,5

Tableware . Table Presentation



Rindenholzbrett „NATURA“

wood plater
tabla de madera con corteza
planche en bois avec écorce



Akazienholz mit Rinde, jedes Brett ein Unikat, vor dem Erstgebrauch mit Speiseöl behandeln
acacia wood with bark, each board unique, treat with cooking oil before first use
madera de acacia con corteza, cada tabla un ejemplar único, tartar con aceite de cocina antes del primer uso
bois d'acacia avec écorce, chaque planche une modèlle unique, traiter avec de l'huile de caisson avant la première utilisation

	cm	↑ cm
00895	26,0 x 24,0	2
00896	30,0 x 28,5	2



Besteckbehälter „TIN“

cutlery bin
recipiente
récipient



Behälter aus Metall mit Tragegriff aus Holz
container made of metal with wooden handle
contenedor de metal con asa de madera
conteneur métallique avec poignée en bois

	cm	↑ cm
00014	24,5 x 12	18,5



Naturschieferplatte
natural slate tray
bandeja pizarra natural
plat ardoise naturelle



mit Absatz Ø 6 cm
with hole Ø 6 cm
con agujero Ø 6 cm
avec trou Ø 6,0 cm

	cm	* mm
00986	25 x 12	6 - 9

passende Gläser:
82310, 82312, 82314,
82316



Naturschieferplatte
natural slate tray
bandeja pizarra natural
plat ardoise naturelle



mit 3 Absätzen, Ø 6 cm
with 3 holes, Ø 6 cm
con 3 agujeros, Ø 6 cm
avec 3 trous, Ø 6 cm

	cm	* mm
00987	28 x 10	6 - 9

passende Gläser:
82310, 82312, 82314,
82316



Naturschieferplatte „STARTER“

natural slate tray
bandeja de pizarra natural
plat ardoise naturelle carré



	cm	mm
00937	20 x 10	6 - 9



Weck-Glas 82316

Naturschieferplatte / Untersetzer

natural slate tray
bandeja de pizarra natural
plateau ardoise naturelle



mit 2 Absätzen Ø 6 cm
with 2 holes Ø 6 cm
con 2 agujeros Ø 6 cm
avec 2 trous Ø 6 cm

	cm	mm
00971	15 x 8	6 - 9



Naturschieferplatte, 2-teilig

natural slate tray, 2 pcs. set
bandeja de pizarra natural y campana
plateau ardoise naturelle et cloche en verre

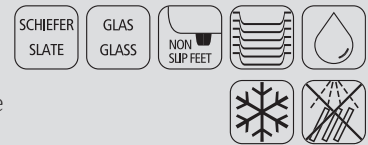

mit Glashaube
with glass cover
con tapa de cristal
avec cloche en verre

	Ø cm	↑ cm	mm
00984	10,5	8	6 - 9



Naturschieferplatte

natural slate tray
bandeja de pizarra natural
plat ardoise naturelle



	cm	mm
00996	45 x 30	6 - 9



Naturschieferplatte

natural slate tray
bandeja de pizarra natural
plat ardoise naturelle



	cm	mm
00994	25 x 25	6 - 9
00995	30 x 30	6 - 9



Konditorplatte
 cake stand
 soporte para pastel
 présentoir à gâteaux



matt poliert
 satin polished finish
 acabado efecto satinado
 poli mat effet satin

	Ø cm	↑ cm
00046	31	3



Servier- / Tortenplatte
 cake stand
 soporte para pastel
 présentoir à gâteaux



Fuß hochglanzpoliert, Platte matt poliert, stabil und sehr standsicher
 foot mirror polished finish, plate satin polished finish
 pie pulido brillante, bandeja pulida mate
 pied brillant, plateau poli satin mat

	Ø cm	↑ cm
00462	30	11



Servier- / Tortenplatte
 cake stand
 soporte para pastel
 présentoir à gâteaux



matt poliert, drehbar, möbelschonende Moosgummi-Unterseite
 satin polished finish, rotating, foam rubber below to save your furniture
 acabado pulido satinado, giratorio, base revestida de goma para no rallar el mobiliario
 poli satiné, plateau tournant, revêtement mousse sous le pied pour ne pas rayer les meubles

	Ø cm	↑ cm
00463	30,5	9



Servier- / Tortenplatte
 cake stand
 soporte para pastel
 présentoir à gâteaux



Fuß matt poliert, stabil und sehr standsicher, möbelschonende Moosgummi-Unterseite
 foot satin polished finish, foam rubber below to save your furniture
 pie pulido con efecto satinado, base revestida de goma para no rallar el mobiliario
 inox poli satin, revêtement mousse sous le pied pour ne pas rayer les meubles

	Ø cm	↑ cm
00464	30	11

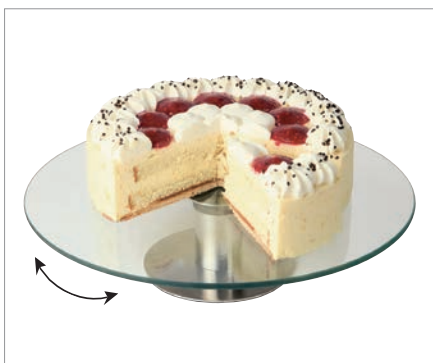

Servier- / Tortenplatte
 cake stand
 soporte para pastel
 présentoir à gâteaux



Fuß matt poliert, drehbar, möbelschonende Moosgummi-Unterseite
 foot satin polished finish, rotating, foam rubber below to save your furniture
 vidrio, pie inox satinado giratorio, base de goma para proteger el mobiliario
 plateau en verre, pied tournant inox poli satin, revêtement mousse sous le pied anti-rayures

	Ø cm	↑ cm
00444	30	7

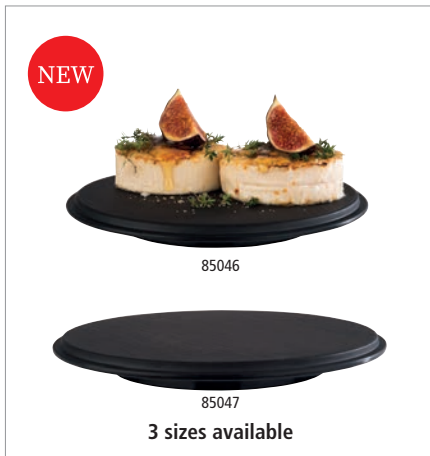

Torten- / Konditorplatte „SLATE“

cake stand
soporte para pastel
présentoir à gâteaux

Rand fixiert die Haube, mit Antirutsch-Füßchen

carved edge fixes the cover, with non-slip feet

ranura para fijar bien la campana, con pies antideslizantes

bord rainuré pour maintenir ferme la cloche, avec pieds antidérapants



	Ø cm	↑ cm	passende Haube / suitable cover / campana adecuada / cloche appropriée
85046	21,5	2,5	06519 NEW
85047	30,5	3,5	06520, 06512
85048	37,5	4,0	06521 NEW



Torten- / Konditorplatte „LOOPS“

cake stand
soporte para pastel
présentoir à gâteaux



	Ø cm	↑ cm	passende Haube / suitable cover / campana adecuada / cloche appropriée
85033	21,5	2,5	06519 NEW
85034	30,5	3,5	06520, 06512, 06510
85035	37,5	4,0	06521 NEW

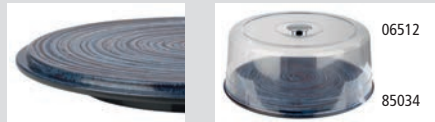

Torten- / Konditorplatte

cake stand
soporte para pastel
présentoir à gâteaux

Rand fixiert die Haube, mit Antirutsch-Füßchen

carved edge fixes the cover, with non-slip feet

ranura para fijar bien la campana, con pies antideslizantes

bord rainuré pour maintenir ferme la cloche, avec pieds antidérapants



	Ø cm	↑ cm	Farbe / Colour
85044	21,5	2,5	White
00468	31,0	3,5	White
85045	37,5	4,0	White
00469	31,0	3,5	Black



Servier- und Tortenplatte „CASUAL“

cake plate
porta pasteles
présentoir à gâteaux



	Ø cm	↑ cm
83890	31	8
83891	31	16



Servier- und Tortenplatte „CASUAL“

cake plate
porta pasteles
présentoir à gâteaux



	cm	↑ cm
83892	31 x 31	8
83893	31 x 31	16

NEW CLASSIC



Servier- und Tortenplatte „CLASSIC“

cake stand
porta pasteles
présentoir à gâteaux

Rand fixiert die Haube
carved edge fixes the cover
ranura para fijar bien la campana
bord rainuré pour maintenir ferme la cloche



	Ø cm	↑ cm
85049	21,5	9
85050	21,5	17
85051	30,5	9
85052	30,5	17
85053	37,5	9
85054	37,5	17

Frischhalte- Haube / cover / campana / cloche



	Ø cm	↑ cm	fits to
06519 <small>NEW</small>	21	17	85049, 85050
06520	30	22	85051, 85052
06521 <small>NEW</small>	36	27	85053, 85054

Frischhalte- Haube / cover / campana / cloche



	Ø cm	↑ cm	fits to
06512	30	11,5	85051, 85052



Servier- und Tortenplatte „ACACIA MINI“

cake stand
porta pasteles
présentoir à gâteaux

Akazienholz geölt
acacia wood oiled
madera de acacia aceitada
bois d'acacia huilé



	Ø cm	↑ cm
33290	9,5	7
33291	13,0	9



Servier- und Tortenplatte „ACACIA“

cake stand
porta pasteles
présentoir à gâteaux

Akazienholz geölt
acacia wood oiled
madera de acacia aceitada
bois d'acacia huilé



	Ø cm	↑ cm
33292	24,0	8
33293	24,0	16
33294	33,0	8
33295	33,0	16
33296	38,5	8
33297	38,5	16



Frischhalte- Haube / cover / campana / cloche



	Ø cm	↑ cm	fits to
06519	21	17	33292, 33293
06520	30	22	33294, 33295
06521	36	27	33296, 33297



Kaviarkühler
caviar cooler
enfriador de caviar
rafraîchisseur de caviar



4-teilig: Glasschale Ø 10 cm
4 pcs.: glass bow Ø 10 cm
set de 4: bol Ø 10 cm
set de 4: bol Ø 10 cm

	Ø cm	↑ cm
01699	18	12



75002
Spieße
skewer

75001
Spießständer
skewer rack

Spießständer / Spieße
espetada and kebab skewer rack / skewer
soporte para brochetas
support pour brochettes



zum Servieren von Fleischspießen bis 40 cm, Gestell aus 8 mm Edelstahl
to serve skewers up to 40 cm, wire stainless steel 8 mm
para servir brochetas de carne hasta 40 cm, grosor del alambre 8 mm, inox
pour présenter les brochettes long. maxi 40 cm, fil 8 mm, inox

	Ø cm	↑ cm	
75001	22,0	46	
75002	0,3	40	4er Set / 4 pcs. set



15925

15926

Butterservierer
butter dish
mantequillera
beurrer



	cm	↑ cm
15925	Ø 9	9
15926	9 x 9	9



Butterservierer
butter dish
mantequillera
beurrer



hochglanzpoliert / mirror polished finish / acabado brillante / poli brillant

	Ø cm	↑ cm
15921	9	7



praktischer Ausgießer
easy pouring



Butter- und Saucenwärmer
butter and sauce pan warmer
calentador de mantequilla y salsa
réchaud à beurre et sauce



Saucentopf mit Ausgießer + Deckel + Gestell (passend für 1 Teelicht)
pan with spout + lid + riser (for 1 light)
cacerola + tapadera + soporte (para 1 vela)
petite casserole avec bec verseur + couvercle + support (pour 1 bougie)

	Ø cm	↑ cm	ltr.	
35350	14	16	0,7	Griff: 13,5 cm / handle: 13,5 cm asa: 13,5 cm / poignée: 13,5 cm



Sauciere
 gravy boat
 salsaera
 saucière



hochglanzpoliert, extra schwere Qualität
 mirror polished finish, high quality
 acabado efecto espejo, alta calidad, base pesada
 poli brillant, belle qualité, pied pesant

	cm	↑ cm	ltr.
40208	13 x 6,0	9,0	0,075
40204	16 x 7,5	9,0	0,125
40205	19 x 9,0	13,0	0,25
40206	22 x 10,5	13,5	0,4



Sauciere
 gravy boat
 salsaera
 saucière



poliert
 polished
 pulido
 poli

	cm	↑ cm	ltr.
40200	18,0 x 7,5	7,0	0,10
40203	21,5 x 9,5	8,5	0,15
40201	23,5 x 10,0	10,0	0,20
40202	23,5 x 12,0	12,0	0,45



Thermo-Sauciere
 insulated sauce boat
 salsaera isotérmica
 saucière thermique



doppelwandig, Klappdeckelverschluss, Einhandbedienung
 double wall, hinged cover, one-hand operation
 doble pared, tapa con bisagra, se maneja con 1 mano
 double paroi, couvercle avec charnière, usage 1 main

	cm	↑ cm	ltr.
40207	19 x 12,5	13	0,4

Tableware . Table Presentation



Gourmet-Löffel „GUN-METAL“

party spoon
cuchara gourmet
cuillère gourmet

EDELSTAHL
STAINLESS
INOX
18/8



→ cm

00693 12 schwarz / gunmetal look PVD coated stainless steel



Gourmet-Löffel „CLASSIC“

party spoon
cuchara gourmet
cuillère gourmet

EDELSTAHL
STAINLESS
INOX



→ cm

00677	13,5	Edelstahl-Look / stainless steel look	
00691	12,0	Gold-Look / gold look	PVD coated stainless steel
00692	12,0	Kupfer-Look / copper look	PVD coated stainless steel



Stielkasserolle / Serviertopf

sauté pan / mini sauce pan
cazo recto bajo
plat à sauter

EDELSTAHL
STAINLESS
INOX



	∅ cm	↑ cm	ltr.	
40642	5,5	2,5	0,05	Griff: 6 cm / handle: 6 cm asa: 6 cm / poignée: 6 cm
40643	7,0	3,5	0,12	Griff: 8,5 cm / handle: 8,5 cm asa: 8,5 cm / poignée: 8,5 cm
40644	9,5	5,5	0,32	Griff: 8,5 cm / handle: 8,5 cm asa: 8,5 cm / poignée: 8,5 cm



Glocke

cloche / dome cover
campana esférica
cloche demi-sphère



außen hochglanzpoliert, innen matt poliert, mit verchromten Griff

outside mirror polished finish, inside satin polished finish, with chromeplated handle
exterior pulido acabado efecto espejo, interior pulido acabado efecto satinado, pomo cromado
extérieur poli brillant, intérieur poli satin, buton chromé

	Ø cm	↑ cm
35734	29	18



Plattteller

plate tray
bajo plato
assiette de présentation



Rand eingerollt

rolled edge
borde redondeado
bord rond

	Ø cm	
35735	31	hochglanzpoliert / mirror polished pulido brillante / poli brillant



Plattteller

plate tray
bajo plato
assiette de présentation



hochglanzpoliert, mit Fadendekor

mirror polished finish, with line edge
pulido efecto espejo, con un filo en relieve
poli miroir, filet relief

	Ø cm	
35730	30,5	
36233	33,0	



Plattteller

plate tray
bajo plato
assiette de présentation



hochglanzpoliert, mit Perlrand

mirror polished finish, with pearl edge
acabado pulido efecto espejo, con borde aperlado
poli miroir, bord perlé

	Ø cm	
35720	30,5	
36323	33,0	



Untersetzer, 6er Set

coaster, 6 pcs. set
posavasos, set de 6
plateau sous-verre, set de 6



hochglanzpoliert, schwere Ausführung, Rand eingerollt
mirror polished finish, heavy quality, rolled edge
acabado pulido efecto espejo, alta calidad, borde redondeado
effet miroir, bord rond, qualité extra

	Ø cm	pcs.
35711	10	6
35912	12	6



Serviettenringe, 6er Set

napkin rings, 6 pcs. set
servilleteros, set de 6
anneaux à serviettes, set de 6



	cm	↑ cm	pcs.
04445	6,5 x 4	1	6



Serviettenringe, 4er Set

napkin rings, 4 pcs. set
servilleteros, set de 4
anneaux porte-serviette, set de 4



	Ø cm	↑ cm	pcs.
04446	4,5	2,5	4



Besteckkorb „ECONOMIC“

cutlery dispenser
dispensador de cubiertos
corbeille à couverts



in Handarbeit geflochten
wickerwork
trensado a mano
tressage à main

	Ø cm	↑ cm	Farbe / Colour
40130	12	15	
40007	12	15	
40012	12	15	
40013	12	15	



Besteckkorb „ECONOMIC“

cutlery dispenser
dispensador de cubiertos
corbeille à couverts



in Handarbeit geflochten
wickerwork
trensado a mano
tressage à main

	cm	↑ cm	Farbe / Colour
40131	27 x 10	4,5	
40009	27 x 10	4,5	
40010	27 x 10	4,5	
40011	27 x 10	4,5	



Table Caddy „COUNTRY STYLE“

table barrel
caddy de mesa
caddy de table



cooler Country-Style, nicht für den direkten Kontakt mit
Lebensmittel verwendbar

condiment and cutlery holders or even for food presentation, the
mini barrels should not come into contact with food, they should
be lined with our greaseproof paper

estilo campo, no aptos para el contacto directo con alimentos,
sólo usando papel alimenticio

de style champêtre, pas de contact direct avec aliments, seulement
en utilisant papier alimentaire

	Ø cm	↑ cm
11930	17,5	8,5
11931	11,5	14,0



Besteckbehälter „ELEMENT“

cutlery bin
 recipiente para cubiertos
 récipients pour couverts



mit Abflussloch, mit weißem Logo, Bodeneinlage aus Silikon zum Schonen des Bestecks, möbelschonende Unterseite
 with drain hole, with white logo, silicone floor inserts for saving the cutlery, with non-scratching undersurface
 con orificio de drenaje, con logotipo blanco, base de silicona para proteger la cuberteria, con base anti rayaduras
 avec trou de drainage, avec logo blanc, insert de silicone pour protéger la coutellerie, avec revêtement antirayures

	∅ cm	↑ cm	Logo
11935	12	14	fork
11936	12	14	knife
11937	12	14	spoon



Besteckbehälter „ACACIA“

cutlery bin
 recipiente para cubiertos
 récipients pour couverts



Akazienholz natur
 acacia wood nature
 madera de acacia natural
 bois d'acacia naturelle

	cm	↑ cm	Logo
11939	14 x 14	15	fork / knife / spoon

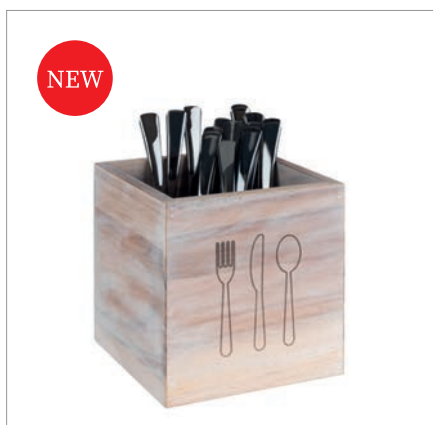

Besteckbehälter „VINTAGE“

cutlery bin
 recipiente para cubiertos
 récipients pour couverts



Akazienholz vintage weiß
 acacia wood, vintage white
 madera de acacia, blanca vintage
 bois d'acacia, blanc vintage

	cm	↑ cm	Logo
11938	14 x 14	15	fork / knife / spoon



Besteckbehälter „ELEMENT“

cutlery bin
recipiente para cubiertos
récipients pour couverts



mit Abflussloch, mit Besteck Logo, Bodeneinlagen aus Silikon
zum Schonen des Bestecks, möbelschonende Unterseite

with drain hole, with cutlery logo, silicone floor inserts for saving the points of knives,
with non-scratching undersurface

con orificio de drenaje, con logotipo de cubertería, soporte de silicona para proteger
las puntas de los cuchillos, con base antirrayaduras

avec le trou de drainage, avec le logo de coutellerie, insert de silicone pour protéger
les pointes des couteaux, avec base revêtue antirayures

	Ø cm	↑ cm
00018	11	14



Tischreste- / Besteckbehälter „TOP CHROME“

table waste bin / cutlery bin
papelera de sobremesa / recipiente para cubiertos
poubelle de table / récipients pour couverts



mit verchromten Rand

with chrome plated ring

con anillo cromado

avec bord chromé

	Ø cm	↑ cm	ltr.	Farbe / Colour
00025	13	15	1	White
00026	13	15	1	Black



Tischreste- / Besteckbehälter „BASE CHROME“

table waste bin / cutlery bin
papelera de sobremesa / recipiente para cubiertos
poubelle de table / récipients pour couverts



mit verchromten Boden

with chrome bottom

con base cromada

avec base chromée

	Ø cm	↑ cm	ltr.	Farbe / Colour
00019	13	15	1,3	White
00020	13	15	1,3	Black



Besteckköcher

cutlery basket
cesta para cubiertos
corbeille à couverts



	Ø cm	↑ cm	
11998	9,7	13,7	Kunststoff weiß / white plastic plástico blanco / plastique blanc
11999	9,7	13,7	matt poliert / satin polished finish acero inoxidable / inox

11998
Köcher weiß

11999
Köcher Edelstahl



Tischreste- / Besteckbehälter

table garbage bin / cutlery bin
papelera de sobremesa / recipiente para cubiertos
poubelle de table / récipients pour couverts



matt poliert, mit abnehmbaren Lochdeckel
satin polished finish, with removeable cover
acabado pulido satinado, con tapa desmontable
poli mat satiné, avec couvercle démontable ouvert au centre

	Ø cm	↑ cm	ltr.
00028	10	12	0,7



Tischrestebehälter

table garbage bin
papelera de sobremesa
poubelle de table



matt poliert, abnehmbarer Schwingdeckel, mit Bajonettverschluss „fester Deckelsitz“
satin polished finish, swing cover, cover removable
acabado satinado, tapa basculante desmontable
poli mat satiné, couvercle basculant démontable

	Ø cm	↑ cm	ltr.
00029	12	17	1,2
00027	10	13	0,7



Tischrestebehälter

table garbage bin
papelera de sobremesa
poubelle de table



Behälter aus weiß lackiertem Metall, Edelstahl-Lochdeckel
metall white, stainless cover with hole
tapa, acero inoxidable, con apertura
couvercle inox, avec ouverture centrale, récipient en acier laqué blanc

	Ø cm	↑ cm	ltr.
00292	12	15	1,2



Tischreste- / Besteckbehälter

table waste bin / cutlery bin
papelera de sobremesa / recipiente para cubiertos
poubelle de table / récipients pour couverts



mit verchromten Rand, inkl. herausnehmbarem Einteiler (4 Fächer)
with chrome plated ring, incl. divider (4 chambers)
con anillo cromado
avec bord chromé

	cm	↑ cm	Farbe / Colour
00016	14 x 14	16	■



Tischrestebehälter „SUNDAY“

table waste bin
papelera de sobremesa
poubelle de table



matt poliert, inkl. Deckel, fester Deckelsitz
satin polished finish, incl. cover, cover removable
acero inoxidable mate, con tapa
inox mat, avec couvercle

	Ø cm	↑ cm	ltr.
00024	10	18	1,1



Tischrestehälter
table garage bin
papelera de sobremesa
poubelle de table



	Ø cm	↑ cm	ltr.	Farbe / Colour
02038	11	14	0,9	weiß
02039	11	14	0,9	schwarz



Tischrestehälter
table garbage bin
papelera de sobremesa
poubelle de table



	Ø cm	↑ cm	ltr.
00311	14	15	1,2



Tischrestehälter
table garbage bin
papelera de sobremesa
poubelle de table



Kunststoff weiß / granit, abnehmbarer Schwingdeckel
white plastic, swing cover, cover removable
plástico blanco/granita, tapa basculante desmontable
plastique blanc/gris chiné, couvercle basculant démontable

	Ø cm	↑ cm	ltr.
00031	12	18	1,4



Tischrestehälter „INTERNATIONAL“
table waste bin
papelera de sobremesa
poubelle de table



Deckel-Ring mit Dichtung, internationale Beschriftung
cover with sealing ring, internationale Beschriftung
tapa con junta, texto multi-idiomas
couvercle avec joint, texte multilingue

	Ø cm	↑ cm	ltr.
83847	10	17,5	1



Tischrestehälter
table garbage bin
papelera de sobremesa
poubelle de table



Behälter aus weiß lackiertem Metall, abnehmbarer Schwingdeckel
cover stainless steel bin metal, white, swing cover
tapa de acero inoxidable, recipiente chapa lacada blanca
couvercle inox basculant, récipient en acier laqué blanc

	Ø cm	↑ cm	ltr.
00291	12	17	1,2

Tableware . Table Presentation



Besteckbehälter „TIN“

cutlery bin
recipiente
récipient

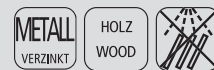

Behälter aus Metall mit Tragegriff aus Holz
container made of metal with wooden handle
contenedor de metal con asa de madera
conteneur métallique avec poignée en bois

	cm	↑ cm
00014	24,5 x 12	18,5



Tischrestebehälter

table garbage bin
papelera de sobremesa
poubelle de table



	Ø cm	↑ cm	ltr
83999	13 / 9	14	1,2



Besteckköcher

cutlery basket
cesta para cubiertos
corbeille à couverts



	cm	↑ cm	Farbe / Colour
84535	12 x 12	16	
84536	12 x 12	16	



Besteckständer

cutlery basket
cesta para cubiertos
égouttoir à couverts



	Ø cm	↑ cm
11921	10	10,0
11922	12	13,5



Mini Staffelei, 2 tlg.
easel mini, 2 pcs. set
caballete mini, set de 2
chevale mini, set de 2

HOLZ
WOOD

1 Ständer aus Akazienholz, 1 Schild kann senkrecht oder waagrecht verwendet werden
1 acacia wood stand, 1 sign can be used vertically or horizontally
1 soporte de madera de acacia, 1 el cartel se puede utilizar vertical u horizontalmente
1 support en bois d'acacia, 1 le panneau peut être utilisé verticalement ou horizontalement

	cm	↑ cm
71520	13,5 x 10,0	19



waagrecht / horizontal



senkrecht / vertical



71490 Kreide-Marker / chalk marker

Inhalt ohne Stift
content without pen
contenido sin bolígrafo
contenu sans stylo



Kartenhalter, 2 tlg.
menu holder, 2 pcs. set
soporte de tarjeta de menú, set de 2
porte-cartes de menu, set de 2

BETON
CONCRETE

ACRYL
ACRYLIC

1 Fuß aus Beton, 1 Menühalter aus Acryl
1 concrete base, 1 acrylic menu sign / holder
1 base de hormigón, 1 letrero de menú acrílico
1 socle en béton, 1 plaque de menu en acrylique

	cm	↑ cm
71496	11,5 x 4,5	10



Kartenhalter, 2 tlg.
menu holder, 2 pcs. set
soporte de tarjeta de menú, set de 2
porte-cartes de menu, set de 2

BETON
CONCRETE

ACRYL
ACRYLIC

1 Fuß aus Beton, 1 Menühalter aus Acryl
1 concrete base, 1 acrylic menu sign / holder
1 base de hormigón, 1 letrero de menú acrílico
1 socle en béton, 1 plaque de menu en acrylique

	cm	↑ cm
71497	15,5 x 6,5	26



Tischstation „RAIL“, 4 tlg.
table station, 4 pcs. set
estación de mesa, set de 4
station de table, set de 4

MF
MELAMINE

GLAS
GLASS

EDELSTAHL
STAINLESS
INOX

Set: 1 Ständer, 1 Salz-, 1 Pfefferstreuer, 1 Zuckerdosierer
set: 1 stand, 1 salt and 1 pepper mills, 1 sugar dispenser
set: 1 soporte, 1 salero y 1 pimentero, 1 azucarero
set: 1 support, 1 salière et 1 poivrière, 1 distributeur de sucre

	cm	↑ cm	Ersatzgläser / replacement lenses
40475	23 x 9	7,5	40509, 40438, 40439



inkl. Kartenhalter
incl. card holder

Seite / page 323, 332

Tableware . Table Presentation



Kartenhalter, 4er Set

table stands, 4 pcs. set
portatarjetas, set de 4
porte-cartes, set de 4



hochglanzpoliert, inkl. 20 schwarze Beschriftungskarten aus Polypropylen
mirror polished finish, incl. 20 black cards made of polypropylene
pulido brillante, incl. 20 tarjetas negras de polipropileno
poli miroir, incl. 20 étiquettes noires en polypropylène

	Ø cm	↑ cm	pcs.	Farbe / Colour
71510	5	10,5	4	stainless steel
71511	5	10,5	4	copper
71512	5	10,5	4	gunmetal



Kartenhalter, 4er Set

table stands, 4 pcs. set
portatarjetas, set de 4
porte-cartes, set de 4



hochglanzpoliert, inkl. 20 schwarze Beschriftungskarten aus Polypropylen
mirror polished finish, incl. 20 black cards made of polypropylene
pulido brillante, incl. 20 tarjetas negras de polipropileno
poli miroir, incl. 20 étiquettes noires en polypropylène

	Ø cm	↑ cm	pcs.	Farbe / Colour
71513	5	15,5	4	stainless steel
71514	5	15,5	4	copper
71515	5	15,5	4	gunmetal



Kartenhalter, 4er Set

table stands, 4 pcs. set
portatarjetas, set de 4
porte-cartes, set de 4



hochglanzpoliert, inkl. 20 schwarze Beschriftungskarten aus Polypropylen
mirror polished finish, incl. 20 black cards made of polypropylene
pulido brillante, incl. 20 tarjetas negras de polipropileno
poli miroir, incl. 20 étiquettes noires en polypropylène

	Ø cm	↑ cm	pcs.	Farbe / Colour
71516	5	20,5	4	stainless steel
71517	5	20,5	4	copper
71518	5	20,5	4	gunmetal



Kartenhalter-Set

card holder set
portatarjetas, set
porte-cartes, set



18-teilig: 6 Kartenhalter 4 x 2,5 cm + 12 Kunststoff-Beschriftungskarten 10 x 6 cm
18 pcs. set: 6 card holder 4 x 2,5 cm + 12 plastic cards of inscription 10 x 6 cm
set de 18: 6 soportes 4 x 2,5 cm + 12 tarjetas de plástico 10 x 6 cm
set de 18: 6 supports 4 x 2,5 cm + 12 étiquettes en plastique 10 x 6 cm

	cm
00022	4 x 2,5



Beschriftungskarten, 10er Set

designation cards, 10 pcs. set
tarjetas, set de 10
étiquettes, set de 10



	cm	✱ mm
00037	7,5 x 5	0,4



Bankettkartenständer

menu stand / table number
 porta-etiqueta o carta de sobremesa
 porte-étiquette de table, porte-menu, ou n° de table



hochglanzpoliert, schwere Qualität
 mirror polished finish, heavy gauge
 acero inoxidable de alta calidad
 inox, belle qualité

	Ø cm	↑ cm
71460	7,5	18,5
71461	7,5	29
71462	7,5	46



Tischkartenhalter, 4er Set

table stands, 4 pcs. set
 pinzas porta-etiquetas, set de 4
 porte-étiquettes à pince, set de 4



hochglanzpoliert, schwerer Fuß, inkl. 20 weiße Beschriftungskarten
 mirror polished finish, heavy food, incl. 20 white labels
 acabado brillante, incluye 20 etiquetas en blanco
 poli brillant, inclut 20 étiquettes blanches

	Ø cm	↑ cm	pcs.
00070	4	10	4



Tischaufsteller, 10er Set

table stands, 10 pcs. set
 caballes de mesa, set de 10
 chevalets de table, set de 10



Ecken abgerundet
 corners rounded
 esquinas redondeadas
 coins arrondies

	cm	↑ cm	pcs.
00011	7,5 x 3,5	5	10
00012	10,5 x 6	6,5	10



Kartenhalter, 2er Set

card holder, 2 pcs. set
 soporte de mesa, set de 2
 support de table, set de 2



inkl. 40 Beschriftungskarten, durch Magnete einfach zusammenklappbar
 incl. 40 cards, easily foldable with magnets
 incluye 40 tarjetas, fácil de plegar, con imanes
 inclut 40 étiquettes, fácil à plier, avec aimants

	cm	↑ cm	pcs.
00076	9 x 3	5,5	2

Tableware . Table Presentation



Buffetschilder, 3er Set

buffet signs, 3 pcs. set
indicadores buffet, set de 3
petits chevalets de buffet, set de 3

EDELSTAHL
STAINLESS
INOX



können mit einem wasserfesten Filzschreiber beschrieben werden
can be marked with water-based felt markers
pueden marcarse con rotuladores de agua
écriture facile avec un feutre lavable à l'eau

	cm	↑ cm	pcs.
03610	12 x 6	6	3

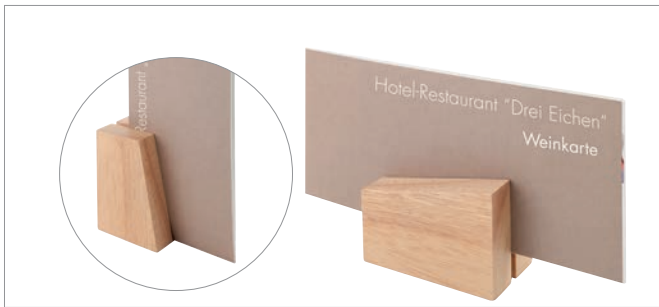

Kartenhalter, 2er Set

menu holder, 2 pcs. set
porta cartas de mesa, set de 2
supports pour menu de table, set de 2

HOLZ
WOOD



	cm	↑ cm	pcs.
00023	8,5 x 6	4,5 / 8,5	2



Kartenhalter, 2er Set

menu holder, 2 pcs. set
porta cartas de mesa, set de 2
porte-menus de table, set de 2

EDELSTAHL
STAINLESS
INOX



matt poliert
satin polished finish
pulido satinado
poli mat satiné

	cm	↑ cm	pcs.
00021	8,5 x 4	4 / 8,5	2

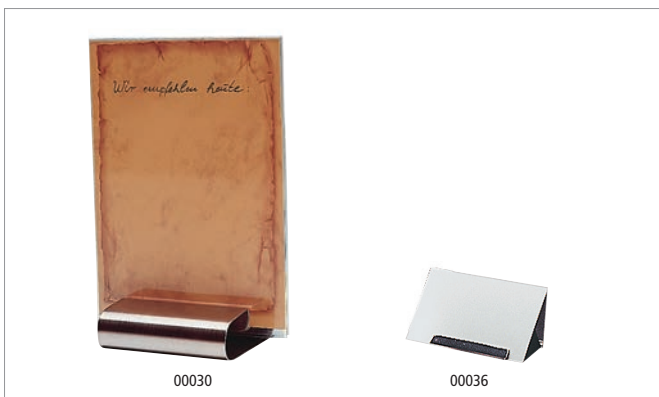

Tischkartenhalter

table stand
soporte-carta para la mesa
support pour menu de table

EDELSTAHL
STAINLESS
INOX



matt poliert
satin polished finish
pulido satinado
poli mat satiné

	cm	↑ cm	pcs.
00030	8 x 7,0	2	1
00036	6 x 4,5	4	1

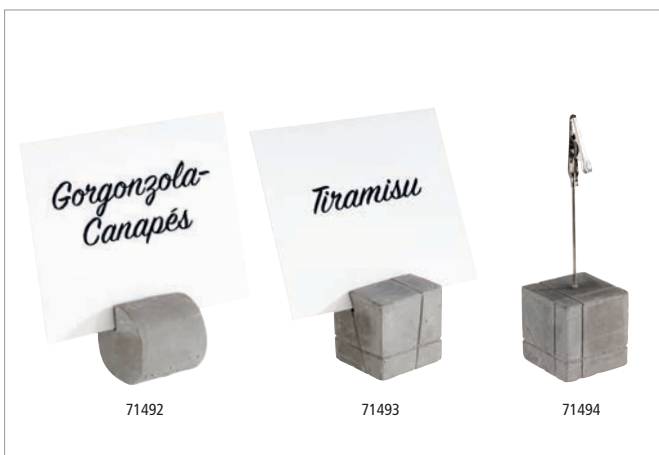

Kartenhalter-Set, 4er Set

table stands, 4 pcs. set
portatarjetas, set de 4
porte-cartes, set de 4

BETON
CONCRETE



inkl. 30 Beschriftungskarten (15 x weiß + 15 x schwarz)
incl. 30 labels (15 x white + 15 x black)
incl. 30 tarjetas (15 x blanco + 15 x negro)
incl. 20 étiquettes (15 x blanc + 15 x noir)

	cm	↑ cm	pcs.
71492	3 x 3	3	4
71493	3 x 3	3	4
71494	3 x 3	12	4



Kartenhalter, 4er Set

table stands, 4 pcs. set
soportes de mesa, set de 4
support de table, set de 4



inkl. 20 weiÙe Beschriftungskarten ca. 10 x 8 cm
incl. 20 white labels 10 x 8 cm
incluye 20 etiquetas blancas 10 x 8 cm
20 étiquettes blanches incluses 10 x 8 cm

	cm	↑ cm	pcs.	Farbe / Colour
00074	3 x 3	12	4	



Kartenhalter, 4er Set

table stands, 4 pcs. set
soportes de mesa, set de 4
support de table, set de 4



inkl. 20 weiÙe Beschriftungskarten ca. 10 x 8 cm
incl. 20 white labels 10 x 8 cm
incluye 20 etiquetas blancas 10 x 8 cm
20 étiquettes blanches incluses 10 x 8 cm

	cm	↑ cm	pcs.	Farbe / Colour
00700	2,5 x 2,5	12	4	



Kartenhalter „WÜRFEL“, 4er Set

table stands, 4 pcs. set
soporte de mesa, set de 4
porte-étiquettes, set de 4



inkl. 20 weiÙe Beschriftungskarten ca. 10 x 8 cm, mehrfach beschriftbar
incl. 20 white labels 10 x 8 cm
incluye 20 etiquetas blancas 10 x 8 cm
20 étiquettes blanches incluses 10 x 8 cm

	cm	pcs.
00078	3 x 3 x 3	4



Kartenhalter „ZYLINDER“, 4er Set

table stands, 4 pcs. set
soporte de mesa, set de 4
porte-étiquettes, set de 4



inkl. 20 weiÙe Beschriftungskarten ca. 10 x 8 cm, mehrfach beschriftbar
incl. 20 white labels 10 x 8 cm
incluye 20 etiquetas blancas 10 x 8 cm
20 étiquettes blanches incluses 10 x 8 cm

	cm	pcs.
00079	3 x 3 x 3	4



Tafelhalter / Schild

slate sign
caballete de mesa, pizarra
plaque signalétique avec support



	cm	↑ cm
00060	12 x 4	7

Tableware . Table Presentation



Kartenhalter, 2er Set

table stands, 2 pcs. set
portatarjetas, set de 2
porte-cartes, set de 2

BETON
CONCRETE



inkl. 30 Beschriftungskarten ca. 10 x 8 cm (15 x weiß + 15 x schwarz)
incl. 30 labels 10 x 8 cm (15 x white + 15 x black)
incl. 30 tarjetas 10 x 8 cm (15 x blanco + 15 x negro)
incl. 20 étiquettes 10 x 8 cm (15 x blanc + 15 x noir)

	cm	↑ cm	pcs.
71495	8 x 3,5	6	2

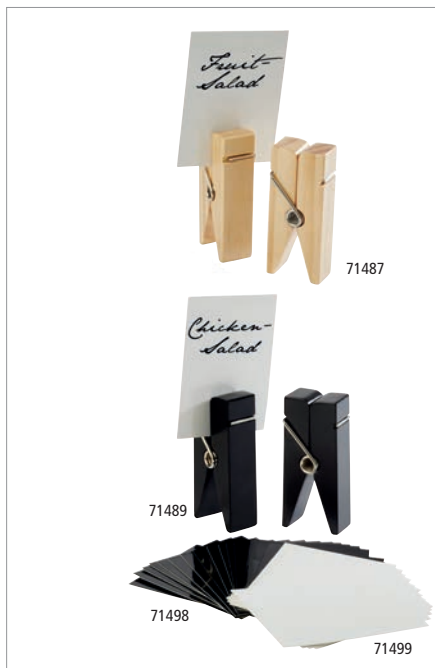

Kartenhalter, 2er Set „KLAMMER“

table stand, 2 pcs. set
soporte de mesa, set de 2
support de table, set de 2

HOLZ
WOOD



inkl. 30 Beschriftungskarten ca. 10 x 8 cm (15 x weiß, 15 x schwarz)
incl. 30 cards 10 x 8 cm (15 x white, 15 x black)
incluye 30 tarjetas 10 x 8 cm (15 x blanco, 15 x negro)
inclut 30 étiquettes 10 x 8 cm (15 x blanc, 15 x noir)

	cm	↑ cm	pcs.	Farbe / Colour
71487	4 x 2,5	10	2	■
71489	4 x 2,5	10	2	■

Beschriftungskarten, 50 Stück / designation cards, 50 pcs. set
cartelitos de designación, 50 piezas / cartes de désignation, 50 pièces

	cm	pcs.	Farbe / Colour	fits to
71498	10 x 8	50	■	71487, 71489
71499	10 x 8	50	■	71487, 71489



Tischkartenhalter „PROFI“

table stand
soporte de mesa
support de table

METALL
VERCHROMT



	cm	↑ cm
40425	9,5 x 7,5	13,5



Tischkartenhalter

table stand
soporte de mesa
support de table

EDELSTAHL
STAINLESS
INOX



möbelschonende Unterseite
non-scratching undersurface
con base antirrayaduras
avec base revêtue antirayures

	cm	↑ cm
00071	14 x 5,5	14



Schilderhalter „FLEXIBEL“

sign holder
soporte para cartelito
support pour menu de table



biegsamer Draht mit zwei Klemmen, extrem flexibel, die Klemmen lassen sich weit öffnen
bedable metal coil adds visual interest, two metal clip open
metal cromado flexible, 2 pinzas con gran apertura
métal chromé, flexible, 2 pinces à grande ouverture

	→ cm	
71470	12	ohne Schilder / without signs sin cartelitos / sans étiquette
71471	23	ohne Schilder / without signs sin cartelitos / sans étiquette
71480	12	inkl. 10 Schilder 11879 / incl. 10 signs 11879 con 10 cartelitos 11879 / avec 10 étiquettes 11879

Schilder, 10er Set / signs, 10 pcs. set / set de 10 cartelitos / set de 10 étiquettes

	cm	
11879	7,7 x 5,2	
12879	5,0 x 3,0	



10 Beschriftungsclips, inkl. 10 Schilder

10 sign holders, with 10 signs
10 soportes + 10 cartelitos
10 supports + 10 étiquettes



	cm	Farbe / Colour
71482	6 x 2,7	White
71483	6 x 2,7	Black

Schilder, 10er Set / signs, 10 pcs. set / set de 10 cartelitos / set de 10 étiquettes

	cm	
11879	7,7 x 5,2	
12879	5,0 x 3,0	



10 Schilderhalter „FLEX CLIP“

10 sign holders
10 clips
10 porte-étiquettes



Durch die bewegliche Verbindung der Klemme und Schilderhalterung ein extrem flexibler Cliphalter!
multi angle ticket clip / inclinable con pinza / inclinable avec pince

	→ cm	Farbe / Colour
71472	9,5	White
71474	9,5	Black

Schilder, 10er Set / signs, 10 pcs. set / set de 10 cartelitos / set de 10 étiquettes

	cm	pcs.
11879	7,7 x 5,2	10
12879	5,0 x 3,0	10



Tischaufsteller 2er Set

table stands, 2 pcs. set
caballetes de mesa, set de 2
chevalets de table, set de 2



	cm	↑ cm	
00017	5,5 x 5	3,5	reserviert
00013	5,5 x 5	3,5	reserved
00572	5,5 x 5	3,5	smoking



Kartenhalter, 4er Set

table stands, 4 pcs.
portatarjetas, set de 4
porte-cartes, set de 4



inkl. 30 Beschriftungskarten ca. 10 x 8 cm (15x weiß, 15x schwarz)
incl. 30 lables 10 x 8 cm (15x white + 15x black)
incl. 30 tarjetas 10 x 8 cm (15x blanco + 15x negro)
incl. 30 étiquettes 10 x 8 cm (15x blanc + 15x noir)

	Ø cm	↑ cm	Farbe / Colour	pcs.
71425	3	10	Marmor weiß / marble white	4
71427	3	10	Marmor grau / marble grey	4



Kartenhalter, 4er Set

table stands, 4 pcs.
portatarjetas, set de 4
porte-cartes, set de 4



inkl. 30 Beschriftungskarten ca. 10 x 8 cm (15x weiß, 15x schwarz)
incl. 30 lables 10 x 8 cm (15x white + 15x black)
incl. 30 tarjetas 10 x 8 cm (15x blanco + 15x negro)
incl. 30 étiquettes 10 x 8 cm (15x blanc + 15x noir)

	cm	↑ cm	Farbe / Colour	pcs.
71426	3,5 x 3,5	10	Marmor weiß / marble white	4
71428	3,5 x 3,5	10	Marmor grau / marble grey	4



Beschriftungsetiketten

labeling labels
etiquetas
étiquettes



12 Bögen mit je 6 Motiven, selbstklebend, mit wasserlöslichem Stift beschreibbar
12 sheets includes 6 self-adhesive and removable labels, use regular chalkboard markers and wipe clean with a clamp cloth
12 hojas, cada una con 6 motivos autoadhesivos, se pueden marcar con un rotulador lavable con agua
12 feuilles chacune avec 6 motifs autoadhésifs, on peut écrire avec un stylo lavable à l'eau

	cm	Farbe / Colour
00069	8,0 x 4,6	■



Kreide-Marker, Stärke 2 mm, 2er Set

chalk marker, 2 pcs. set
rotulador de tiza, set de 2
marqueur a la craie liquide, set de 2



Zum Gestalten und Beschriften von Tafeln, Glas und fast allen geschlossenen Oberflächen, deckende Flüssigkreide auf Wasserbasis, feucht abwischbar

For decorating and writing on boards, glass and almost all non-porous surfaces, opaque water-based liquid chalk, wet-wipeable
Rotuladores para pizarra de tiza líquida para decorar y escribir sobre pizarras, cristales y casi todas las superficies no porosas. Tizi líquida opaca al agua que se pueda borrar con un trapo
Pour décorations et inscriptions sur tableaux, verre et presque toutes les surfaces non poreuses, craie liquide opaque à base d'eau, effaçable avec un chiffon humide

	Ø cm	↑ cm	Farbe / Colour	pcs.
71490	1	13	■	2
71491	1	13	■	2



Rechnungstablett

bill presenter
porta cuenta
porte-addition



mit Klemme für Rechnung
with clip for bill
con clip para la nota
avec clip pour la note

	cm	↑ cm
30108	20 x 12	0,5



Rechnungstablett

bill presenter
porta cuenta
porte-addition



mit Klemme für Rechnung
with clip for bill
con clip para la nota
avec clip pour la note

	cm	↑ cm
30110	17 x 11	1



Rechnungstablett, 2er Set

bill presenter, 2 pcs. set
porta cuenta, set de 2
porte-addition, set de 2



1 Edeltahl-Tablett hochglanzpoliert + 1 klappbare Ledermappe
mit Stiftflasche, mit Magnethalterung

1 stainless tray mirror polished finish + 1 leather presenter, with magnetic system

1 bandeja de acero inoxidable pulido brillante + 1 presentador de cuero con sistema magnético

1 plateau inox poli brillant + 1 pochette cuir aimantée

	cm	↑ cm
30109	20 x 16	2



Tischkrümelentferner

crumber
recogemigas
ramasse-miettes



matt poliert

satin polished finish

acabado mate, fácil de usar, mango hueco

mat satiné, manche creux, simple à utiliser

	Ø cm	↑ cm	
00058	6,5 x 2,5	22	Hohlgriff / hollow handles
00581	19,5 x 4,5	1	geschliffene Edeltahlkante flat grinded stainless steel edge



Pfeffermühle „COPPER“

pepper mill
molinillo de pimienta
moulin à poivre



Mahlwerk aus Carbonstahl, Mahlgrad stufenlos einstellbar

mill in carbon steel, the grinding degree can be adjusted infinitely
molinillo de acero al carbono, el grado de molino se puede ajustar de modo continuo
moulin en acier de carbone, la finesse de mouture se peut régler de façon continue

	∅ cm	↑ cm
40551	6	15



Salzmühle „COPPER“

salt mill
molinillo de sal
moulin à sel



Mahlwerk aus Edelstahl, Mahlgrad stufenlos einstellbar

mill in stainless steel, the grinding degree can be adjusted infinitely
molinillo de acero inoxidable, el grado de molino se puede ajustar de modo continuo
moulin en acier inox, la finesse de mouture se peut régler de façon continue

	∅ cm	↑ cm
40552	6	15



Pfeffermühle „FRIDA“

pepper mill
molinillo de pimienta
moulin à poivre

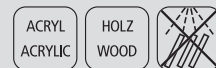

Mahlwerk aus Carbonstahl, Mahlgrad stufenlos einstellbar

mill in carbon steel, the grinding degree can be adjusted infinitely
molinillo de acero al carbono, el grado de molino se puede ajustar de modo continuo
moulin en acier de carbone, la finesse de mouture se peut régler de façon continue

	∅ cm	↑ cm
40549	6	15,5



Salzmühle „FRIDA“

salt mill
molinillo de sal
moulin à sel

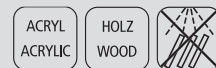

Mahlwerk aus Edelstahl, Mahlgrad stufenlos einstellbar

mill in stainless steel, the grinding degree can be adjusted infinitely
molinillo de acero inoxidable, el grado de molino se puede ajustar de modo continuo
moulin en acier inox, la finesse de mouture se peut régler de façon continue

	∅ cm	↑ cm
40550	6	15,5





Pfeffermühle „DIAMOND“

pepper mill
molinillo de pimienta
moulin à poivre



Mahlwerk aus Carbonstahl, Mahlgrad stufenlos einstellbar

mill in carbon steel, the grinding degree can be adjusted infinitely
molinillo de acero al carbono, el grado de molino se puede ajustar de modo continuo
moulin en acier de carbone, la finesse de mouture se peut réglée de façon continue

	Ø cm	↑ cm
40553	6	18



Salzmühle „DIAMOND“

salt mill
molinillo de sal
moulin à sel



Mahlwerk aus Edelstahl, Mahlgrad stufenlos einstellbar

mill in stainless steel, the grinding degree can be adjusted infinitely
molinillo de acero inoxidable, el grado de molino se puede ajustar de modo continuo
moulin en acier inox, la finesse de mouture se peut réglée de façon continue

	Ø cm	↑ cm
40554	6	18

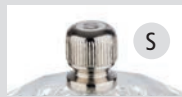

Pfeffermühle „GUNMETAL“

pepper mill
molinillo de pimienta
moulin à poivre



Mahlwerk aus Carbonstahl, Mahlgrad stufenlos einstellbar

mill in carbon steel, the grinding degree can be adjusted infinitely
molinillo de acero al carbono, el grado de molino se puede ajustar de modo continuo
moulin en acier de carbone, la finesse de mouture se peut réglée de façon continue

	Ø cm	↑ cm
40555	6	15,5

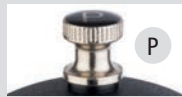

Salzmühle „GUNMETAL“

salt mill
molinillo de sal
moulin à sel



Mahlwerk aus Edelstahl, Mahlgrad stufenlos einstellbar

mill in stainless steel, the grinding degree can be adjusted infinitely
molinillo de acero inoxidable, el grado de molino se puede ajustar de modo continuo
moulin en acier inox, la finesse de mouture se peut réglée de façon continue

	Ø cm	↑ cm
40556	6	15,5





Pfeffermühle „ELEMENT“

pepper mill
molinillo de pimienta
moulin à poivre

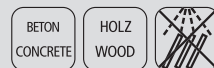

Mahlwerk aus Carbonstahl, Mahlgrad stufenlos einstellbar

mill in carbon steel, the grinding degree can be adjusted infinitely
molinillo de acero al carbono, el grado de molino se puede ajustar de modo continuo
moulin en acier de carbone, la finesse de mouture se peut réglée de façon continue

	Ø cm	↑ cm
40557	7,5	15,5



Salzmühle „ELEMENT“

salt mill
molinillo de sal
moulin à sel

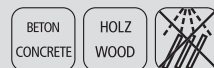

Mahlwerk aus Edelstahl, Mahlgrad stufenlos einstellbar

mill in stainless steel, the grinding degree can be adjusted infinitely
molinillo de acero inoxidable, el grado de molino se puede ajustar de modo continuo
moulin en acier inox, la finesse de mouture se peut réglée de façon continue

	Ø cm	↑ cm
40558	7,5	15,5



Pfeffermühle „ELEMENT“

pepper mill
molinillo de pimienta
moulin à poivre

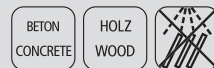

Mahlwerk aus Carbonstahl, Mahlgrad stufenlos einstellbar

mill in carbon steel, the grinding degree can be adjusted infinitely
molinillo de acero al carbono, el grado de molino se puede ajustar de modo continuo
moulin en acier de carbone, la finesse de mouture se peut réglée de façon continue

	Ø cm	↑ cm
40538	6	18

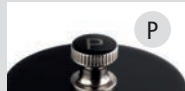

Salzmühle „ELEMENT“

salt mill
molinillo de sal
moulin á sel

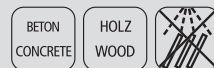

Mahlwerk aus Edelstahl, Mahlgrad stufenlos einstellbar

mill in stainless steel, the grinding degree can be adjusted infinitely
molinillo de acero inoxidable, el grado de molino se puede ajustar de modo continuo
moulin en acier inox, la finesse de mouture se peut réglée de façon continue

	Ø cm	↑ cm
40539	6	18





Pfeffer- u. Salzmühle „PROFESSIONAL“

salt / pepper mill
 molinillo de sal / pimienta
 moulin à sel / poivre



Mahlgrad stufenlos einstellbar

the grinding degree can be adjusted infinitely
 el grado de molino se puede ajustar de modo continuo
 la finesse de mouture se peut réglée de façon continue

	Ø cm	↑ cm	Farbe / Colour	
40540	5,5	15		pepper mill
40541	5,5	15		salt mill



Pfeffermühle „PROFESSIONAL VINTAGE“

pepper mill
 molinillo de pimienta
 moulin à poivre



Deutsches Buchenholz, vintage, Mahlwerk aus Carbonstahl, Mahlgrad stufenlos einstellbar

German beechwood, vintage, mill in carbon steel,
 the grinding degree can be adjusted infinitely
 madera de haya alemana, carácter „vintage“, molinillo de acero al carbono, el grado de molino se puede ajustar de modo continuo
 bois de hêtre d'Allemagne, vintage, moulin en acier de carbone, la finesse de mouture se peut réglée de façon continue

	Ø cm	↑ cm	Farbe / Colour
40535	5,5	15	
40537	6,0	23	
40546	5,5	15	
40548	6,0	23	



Pfeffermühle

pepper mill
 molinillo de pimienta
 moulin à poivre



Mahlwerk aus Carbonstahl, Mahlgrad stufenlos einstellbar

mill in carbon steel, the grinding degree can be adjusted infinitely
 molinillo de acero al carbono, el grado de molino se puede ajustar de modo continuo
 moulin en acier de carbone, la finesse de mouture se peut réglée de façon continue

	Ø cm	↑ cm	Farbe / Colour
40559	5,5	18	



Salzmühle

salt mill
 molinillo de sal
 moulin à sel



Mahlwerk aus Edelstahl, Mahlgrad stufenlos einstellbar

mill in stainless steel, the grinding degree can be adjusted infinitely
 molinillo de acero inoxidable, el grado de molino se puede ajustar de modo continuo
 moulin en acier inox, la finesse de mouture se peut réglée de façon continue

	Ø cm	↑ cm	Farbe / Colour
40560	5,5	18	



Salzmühle „PROFESSIONAL VINTAGE“

salt mill
molinillo de sal
moulin à sel



Deutsches Buchenholz, vintage, Mahlwerk aus Edelstahl, Mahlgrad stufenlos einstellbar

German beechwood, vintage, mill in stainless steel, the grinding degree can be adjusted infinitely

madera de haya alemana, carácter „vintage“, molinillo de acero inoxidable, el grado de molino se puede ajustar de modo continuo

bois de hêtre d'Allemagne, vintage, moulin en acier inox, la finesse de mouture se peut régler de façon continue

	Ø cm	↑ cm	Farbe / Colour
40536	5,5	15	
40547	5,5	15	



Pfeffermühle „PROFESSIONAL“

pepper mill
molinillo de pimienta
moulin à poivre



Mahlwerk aus Carbonstahl, Mahlgrad stufenlos einstellbar

mill in carbon steel, the grinding degree can be adjusted infinitely

molinillo de acero al carbono, el grado de molino se puede ajustar de modo continuo

moulin en acier de carbone, la finesse de mouture se peut régler de façon continue

	Ø cm	↑ cm	Farbe / Colour
40530	5,5	15	Holz / wood
40532	7,0	30	Holz / wood
40534	7,0	40	Holz / wood



Mahlgrad einstellbar
grinder setting

	Ø cm	↑ cm	Farbe / Colour
40520	5,5	15	Holz / wood
40522	7,0	30	Holz / wood
40524	7,0	40	Holz / wood



Mahlgrad einstellbar
grinder setting



Salzmühle „PROFESSIONAL“

salt mill
molinillo de sal
moulin à sel



Mahlwerk aus Edelstahl, Mahlgrad stufenlos einstellbar

mill in stainless steel, the grinding degree can be adjusted infinitely

molinillo de acero inoxidable, el grado de molino se puede ajustar de modo continuo

moulin en acier inox, la finesse de mouture se peut régler de façon continue

	Ø cm	↑ cm	Farbe / Colour
40531	5,5	15	Holz / wood
40521	5,5	15	Holz / wood



Tablett

tray
bandeja
plateau

mit 2 Absätzen Ø 6 cm
with 2 holes Ø 6 cm
con 2 agujeros Ø 6 cm
avec 2 trous Ø 6 cm



	cm	↑ cm
84039	16,5 x 8,5	1,5



Naturschieferplatte / Untersetzer

natural slate tray
bandeja de pizarra natural
plateau ardoise naturelle

mit 2 Absätzen Ø 6 cm
with 2 holes Ø 6 cm
con 2 agujeros Ø 6 cm
avec 2 trous Ø 6 cm



	cm	* mm
00971	15 x 8	6 - 9



2 in 1 Salz- u. Pfeffermühle

2 in 1 salt / pepper mill
2 in 1 molinillo de sal / pimienta
2 in 1 moulin à sel / poivre

Keramik Mahlwerk
ceramic mechanism
molinillo de cerámica
broyeur en céramique



	Ø cm	↑ cm
40545	7,5	18,5



Mahlgrad einstellbar
grinder setting

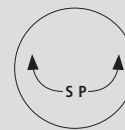

2 in 1 Salz- u. Pfeffermühle

2 in 1 salt / pepper mill
2 in 1 molinillo de sal / pimienta
2 in 1 moulin à poivre / sel

Keramik Mahlwerk
ceramic mechanism
molinillo de cerámica
broyeur en céramique



	cm	↑ cm
40544	6 x 4,5	9,5



Mahlgrad einstellbar
grinder setting

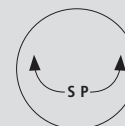



Käse- oder Gewürzstreuer

spice shaker
botes especieros
saupoudreuse à épices

Löcher Ø 5 mm, inkl. Staubdeckel
holes Ø 5 mm, incl. cover
agujeros Ø 5 mm, tapa plástico
trous Ø 5 mm, couvercle plastique



	Ø cm	↑ cm	ltr.
00775	5,5	7,5	0,15



Netzstreuer

mesh top shaker
polvoreador, tapa con malla fina
pot à épices, couvercle toile fine

inkl. Staubdeckel
incl. cover
tapa plástico
couvercle plastique



	Ø cm	↑ cm	ltr.
00776	5,5	7,5	0,15



Streuer fein

small hole shaker
polvoreador, tapa con agujeros pequeños
pot à épices, couvercle à petits trous

Löcher Ø 1 mm, inkl. Staubdeckel
holes Ø 1 mm, incl. cover
agujeros Ø 1 mm + tapa plástico
trous Ø 1 mm + couvercle plastique



	Ø cm	↑ cm	ltr.
00777	5,5	7,5	0,15



Streuer grob

large hole shaker
polvoreador, tapa con agujeros grandes
pot à épices, couvercle à grands trous

Löcher Ø 2,5 mm, inkl. Staubdeckel
holes Ø 2,5 mm, incl. cover
agujeros Ø 2,5 mm + tapa plástico
trous Ø 2,5 mm + couvercle plastique



	Ø cm	↑ cm	ltr.
00778	5,5	7,5	0,15



Multistreuer
multi-functional shaker
salero
saupoudreuse



	Ø cm	↑ cm	ltr.
00774	7	12	0,20



geschlossen Ø 2 mm Ø 4 mm Ø 6 mm



Multistreuer
multi-functional shaker
salero
saupoudreuse



	Ø cm	↑ cm	ltr.
00773	6	8	0,05



geschlossen Ø 2 mm Ø 4 mm Ø 6 mm



Netzstreuer
mesh top shaker
polvoreador, tapa con malla fina
pot à épices, couvercle toile fine



	Ø cm	↑ cm	ltr.
00781	6,5	12	0,20



Multistreuer / Gewürzstreuer
multi-functional shaker
juego dosificador
jeu de salières



	Ø cm	↑ cm	ltr.
00782	6,5	12	0,20

00783	6,5	12	0,20	mit 8 Löchern / with 8 holes con 8 agujeros / avec 8 trous
-------	-----	----	------	---



00782 - Ø 2 mm 00783 - Ø 8 mm

Tableware . Table Presentation



Salz- und Pfefferstreuer, 2er Set

salt - and pepper shaker, 2 pcs. set
piezas de sal y pimienta, set de 2
sel et poivre, set de 2



	Ø cm	↑ cm	pcs.	
40500	5	6,5	2	glatte Ausführung / smooth version versión recta / forme lisse
40501	5	6,5	2	geriffelte Ausführung / fluted version versión ondulada / forme ondulée
40507	6	10,0	2	



Allzweckstreuer, 12er Set

shaker, 12 pcs. set
dosificador, set de 12
salières/poivrières, set de 12



	cm	↑ cm	pcs.	
40504	4 x 4	10	12	13 Löcher / 13 holes 13 agujeros / 13 trous
40505	4 x 4	10	12	3 Löcher / 3 holes 3 agujeros / 3 trous



40504

40505



Ministreuer, 4er Set

smaller shaker, 4 pcs. set
bodegas pequeñas, set de 4
mini-salières, set de 4



	Ø cm	↑ cm	pcs.
40503	3,5	4	4



Salzstreuer

salt shaker
salero
salière



Pommes-Frites Streuer mit Schraubkappe

for french fries, cover to screw
para patatas fritas, tapa de rosca
pour les frites, couvercle à visser

	Ø cm	↑ cm	
00779	8	17	Aluminium / aluminium aluminio / aluminium
00772	8	17	Edelstahl / stainless steel acero inoxidable / inox



Pfeffer- & Salz-Menage „WOOD“

salt- and pepper-menage
salero-pimentero
ménage sel et poivre



matt poliert, Glasbehälter mit Edelstahl-Deckel und Deckelverschluss
satin polished finish, glass with stainless steel cover
pulido acabado efecto satinado, cristal con tapa de acero inoxidable
verre et inox mat satiné

	cm	↑ cm
40435	11,5 x 5,5	17



Essig- & Öl-Menage „WOOD“

oil- and vinegar-menage
aceitera-vinagrera
ménage huile et vinaigre



matt poliert, Glasbehälter mit Edelstahl-Deckel und Deckelverschluss
satin polished finish, glass with stainless steel cover
pulido acabado efecto satinado, cristal con tapa de acero inoxidable
verre et inox mat satiné

	cm	↑ cm
40436	16 x 7,5	24,5



Pfeffer-, Salz-, Essig- und Öl-Menage „WOOD“

salt- and pepper- and oil- and vinegar-menage
salero-pimentero & aceitera-vinagrera
ménage sel et poivre & huile et vinaigre



matt poliert, möbelschonende Unterseite
satin polished finish, glass with stainless steel cover
pulido acabado efecto satinado, con tapa de acero inoxidable
verre et inox mat satiné, avec couvercle inox

	cm	↑ cm
40437	15,5 x 12	24,5

Salz- und Pfefferstreuer / salt - and pepper shaker / juego de sal y pimienta / set sel et poivre

	Ø cm	↑ cm	
40438	4	9	6 Löcher - Ø 1,85 mm
40439	4	9	18 Löcher - Ø 1,35 mm

Ersatzglas Essig / Öl / spare glass vinegar / oil / cristal de recambio con tapa „aceite & vinagre“
verre huile ou vinagre

	Ø cm	↑ cm	litr.
40442	6	18,5	0,2



praktischer Ausgießer
no drips pourer

Tableware . Table Presentation



Pfeffer- und Salz-Menage „ELEMENT“

salt- and pepper-menage
salero-pimentero
ménage sel et poivre



Beton-Ständer, Glasbehälter mit Edelstahl-Deckel, möbelschonende Unterseite

stand made of concrete, glass with stainless steel cover, furniture-friendly underside

soporte de hormigón, recipiente de vidrio con tapa de acero inoxidable, con base anti rayaduras
support en béton, récipient en verre avec couvercle en acier inox, avec revêtement antirayures

	cm	↑ cm
40410	10 x 6	17



Essig- und Öl-Menage „ELEMENT“

oil- and vinegar-menage
aceitera-vinagrera
ménage huile et vinaigre



Beton-Ständer, Glasbehälter mit Edelstahl-Deckel und tropffreiem Kunststoff-Ausgießer, möbelschonende Unterseite

stand made of concrete, glass with stainless steel cover and non-drip nozzle-spout, furniture-friendly underside

soporte de hormigón, recipiente de vidrio con tapa de acero inoxidable y sistema antigoteo, con base anti rayaduras
support en béton, récipient en verre avec couvercle en acier inox et verseur antigoutte, avec revêtement antirayures

	cm	↑ cm
40411	14 x 8	25



Pfeffer-, Salz-, Essig- und Öl-Menage „ELEMENT“

salt- and pepper- and oil- and vinegar-menage
salero-pimentero & aceitera-vinagrera
ménage sel et poivre & huile et vinaigre



Beton-Ständer, Glasbehälter mit Edelstahl-Deckel und Drehverschluss, möbelschonende Unterseite

stand made of concrete, glass with stainless steel cover and screw cap, furniture-friendly underside

soporte de hormigón, recipiente de vidrio con tapa de acero inoxidable y tapón de rosca, con base anti rayaduras
support en béton, récipient en verre avec couvercle en acier inox et bouchon à vis, avec revêtement antirayures

	cm	↑ cm
40412	12,5 x 12,5	25



Pfeffer-, Salz-, Essig- und Öl-Menage „ELEMENT“

salt- and pepper- and oil- and vinegar-menage
salero-pimentero & aceitera-vinagrera
ménage sel et poivre & huile et vinaigre



Beton-Ständer mit Kartenhalterung, Glasbehälter mit Edelstahl-Deckel und Drehverschluss, möbelschonende Unterseite

stand made of concrete with card holder, glass with stainless steel cover and screw cap, furniture-friendly underside

soporte de hormigón con tarjetero, recipiente de vidrio con tapa de acero inoxidable y tapón de rosca, con base anti rayaduras
support en béton avec porte-cartes, récipient en verre avec couvercle en acier inox et bouchon à vis, avec revêtement antirayures

	cm	↑ cm
40413	14 x 13,5	20



mit Kartenhalterung an der Rückseite
with card holder at the back



Pfeffer- & Salz-Menage „CLASSIC“

salt- and pepper-menage
salero-pimentero
ménage sel et poivre



Glasbehälter mit Edelstahl-Deckel und Drehverschluss

glass with stainless steel cover
vidrio con tapa de acero inoxidable con rosca
en verre avec couvercle inox à visser

	cm	↑ cm
40310	10,5 x 6,5	16



Pfeffer- & Salz-Menage „CLASSIC“

salt- and pepper-menage
salero-pimentero
ménage sel et poivre



Glasbehälter mit Edelstahl-Deckel und Drehverschluss

glass with stainless steel cover
vidrio con tapa de acero inoxidable con rosca
en verre avec couvercle inox à visser

	Ø cm	↑ cm
40320	10,5	16



Menage „CLASSIC“

menage
menage
ménage



Glasbehälter mit Edelstahl-Deckel und tropffreiem Kunststoff-Ausgießer

with stainless steel cover and non-drip nozzle-spout
vidrio con tapa inox y sistema antigoteo
verre avec couvercle inox et verseur antigoutte

	cm	↑ cm	ltr.
40440	14,5 x 8,5	23	0,2
40450	17,5 x 10,5	23	

Ersatzglas mit Deckel / spare glass with cover / vidrio con tapa / verre + couvercle

	Ø cm	↑ cm	
40312	4	9	18 Löcher - Ø 1,35 mm
40311	4	9	6 Löcher - Ø 1,85 mm

Ersatzglas mit Deckel „Essig & Öl“ / spare glass with cover „vinegar & oil“ / cristal de recambio con tapa „vinegar & oil“ / verre huile ou vinaige avec couvercle inox et verseur antigoutte

	Ø cm	↑ cm	ltr.
40441	6	18,5	0,2

Ersatzglas mit Deckel „Zahnstocher“ / spare glass with cover „toothpick“ / porta-palillos vidrio con tapa / verre à cure-dents + couvercle

	Ø cm	↑ cm
40313	4	9



Senftöpfchen, 2er Set

mustard glass, 2 pcs. set
piezas vasos mostaza, set de 2
verres à moutarde, set de 2



inkl. Löffel und Edelstahl-Deckel

incl. spoons and covers
incluye cucharas y tapas
cuillères et couvercles inclus

	Ø cm	↑ cm	pcs.
40415	5	6	2



Menage „ECONOMIC“

menage
menage
ménage



Glasbehälter mit Edelstahl-Deckel und Drehverschluss

glass with stainless steel cover
cristal con tapa inox a rosca
en verre avec couvercle inox à visser

	cm	↑ cm
40455	8 x 4	13



Menage „ECONOMIC“

menage
menage
ménage



Glasbehälter mit Edelstahl-Deckel und Drehverschluss

glass with stainless steel cover
cristal con tapa inox a rosca
en verre avec couvercle inox à visser

	cm	↑ cm
40457	8 x 8	12

Glas für Senf / glass for mustard / vaso de cristal para mostaza / pot verre seul pour la moutarde

40464



Menage „ECONOMIC“

menage
menage
ménage



Glasbehälter mit Edelstahl-Deckel und tropffreiem Kunststoff-Ausgießer

glasses with stainless steel cover and non-drip nozzle-spout
cristales con tapa de acero inoxidable y sistema antigoteo
en verre avec couvercle inox et insert plastique antigoutte

	cm	↑ cm
40458	11,5 x 5,5	22
40460	11,0 x 10,5	22

40458

Pfeffer- oder Salz-Glasstreuer / pepper- or salt-glass with cover salero o pimentero de cristal con tapa / salière ou poivrière seule en verre avec couvercle inox

	Ø cm	↑ cm
40461	3	9

Essig- oder Öl-Glasbehälter / oil- or vinegar-glass with cover / aceitera-vinagrera con tapa bouteille huile ou vinaigre seule en verre et couv. inox

	Ø cm	↑ cm
40462	4,5	16

Glas für Zahnstocher / glass for tooth picks / vaso de cristal para palillos de dientes porte-cure-dents env erre

	Ø cm	↑ cm
40463	3	6

40460



Menage „PRO“

menage
menage
ménage



matt poliert, Glasbehälter mit Edelstahl-Deckel und tropffreiem Kunststoff-Ausgießer

satin polished finish, glass with stainless steel cover and non-drip nozzle-spout

inox satinado, vidrio, sistema antigoteo

inox poli mat satiné et verre, insert plastique antigoutte

	cm	↑ cm
40476	12,0 x 8,0	19
40478	12,5 x 11,0	19
40480	13,0 x 11,0	19

Pfeffer- oder Salz-Glasstreuer / pepper- or salt-glass with cover / salero o pimentero de cristal con tapa
salière ou poivrière seule en verre avec couvercle inox

	Ø cm	↑ cm
40461	3	9

Essig- oder Öl-Glasbehälter / oil- or vinegar-glass with cover / aceitera-vinagrera con tapa
bouteille huile ou vinaigre seule en verre et couv. inox

	Ø cm	↑ cm
40462	4,5	16



Menage „PRO“

menage
menage
ménage



matt poliert, Glasbehälter mit Edelstahl-Deckel und Drehverschluss

satin polished finish, glass with stainless steel cover

inox satinado, vidrio y tapas con rosca

inox poli mat satiné et verre, couvercle à visser

	cm	↑ cm
40470	8,5 x 5,7	11,5
40472	9,2 x 8,5	11,5
40474	10,0 x 10,0	11,5



Parmesan-Menage „CLASSIC“

cheese dish
quesera parmesano
service à parmesan

hochglanzpoliert, inkl. Löffel
mirror polished finish, with spoon
pulido efecto espejo, con bol cristal y cuchara
brillant, avec bol verre et cuillère



	Ø cm	↑ cm
40330	10,5	7

Ersatzbehälter / sparecontainer / bol de recambio / bol de rechange

	Ø cm
40331	10,5



Parmesan-Menage „PROFI“

cheese dish
quesera parmesano
service à parmesan



	Ø cm	↑ cm
40424	9	5,5

Ersatzbehälter / sparecontainer / bol de recambio / bol de rechange

	Ø cm
40331	10,5



Parmesan-Menage „PRO“

cheese dish
quesera parmesano
service à parmesan

matt poliert, inkl. Löffel
satin polished finish, with spoon
pulido mate satinado, con bol cristal y cuchara
mat satiné, avec bol verre et cuillère



	Ø cm	↑ cm
40482	10,5	13

Ersatzbehälter / sparecontainer / bol de recambio / bol de rechange

	Ø cm
40331	10,5



Parmesan-Menage „ECONOMIC“

cheese dish
quesera parmesano
service à parmesan

inkl. Kunststofflöffel
with spoon
con cuchara
avec cuillère



	Ø cm	↑ cm
40453	10,5	7

Ersatzbehälter / sparecontainer / bol de recambio / bol de rechange

	Ø cm
40454	10,5



Essig- & Öl-Menage
oil- and vinegar-menage
aceitera-vinagrera
ménage huile et vinaigre



Glasbehälter mit Deckel und tropffreiem PE-Ausgießer

glass with lid and non-drip nozzle-spout

recipiente de cristal con tapa y sistema antigoteo

pot en verre avec couvercle et système plastique antigoutte

	cm	↑ cm	litr.
40445	10,5 x 5,5	24	0,12
40446	13,0 x 7,0	34	0,50



tropffreier Ausgießer
non-drip spout



250 ml

Ständer
serving stand
soporte 2 botellas
support 2 bouteilles



matt poliert, passend für handelsübliche 500 ml Flaschen, Lieferung ohne Flaschen

satin polished finish, for standard bottles with 500 ml content, delivery without bottles

inox satinado, para botellas estándar de 500 ml, se entrega sin botellas

inox mat satiné, pour bouteilles standard de 500 ml, livré sans bouteilles

	cm	↑ cm
40443	13 x 7	30



Gewürzständer
condiment stand
soporte salsas y condimentos
porte condiments et sauces



matt poliert, Lieferung ohne Deko

satin polished finish

acabado pulido efecto satinado

poli mat satiné

	Ø cm	↑ cm
40300	19	20



Menage
menage
menage
ménage



drehbares Gestell, Glasbehälter mit Edelstahl-Deckel und Drehverschluss

rotating stand, glass with stainless steel cover

soporte giratorio con piezas de vidrio y tapas inox

tournant, avec pièces en verre et couvercle inox

	Ø cm	↑ cm
40485	16	20

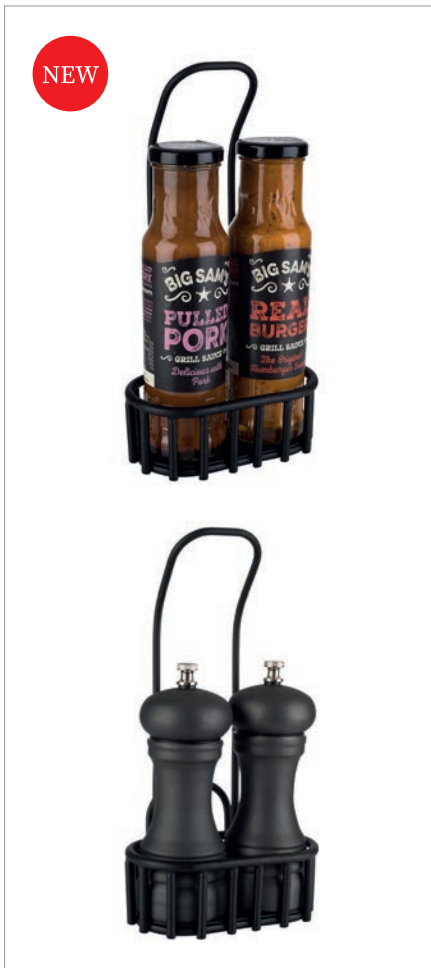

NEW

Ständer „URBAN“

serving stand
soporte 2 botellas
support 2 bouteilles

Metall schwarz, mit Kartenhalterung
metal black, with card holder
metal negro, con tarjetero
métal noir, avec porte-cartes



	cm	↑ cm
40414	13 x 8,5	25



mit Kartenhalterung an der Rückseite
with card holder at the back



NEW

350 ml

Essig- & Öl-Flasche „OLD FASHIONED“

oil- and vinegar bottle
botella de aceite y vinagre
bouteille d'huile et vinaigre

Glasflasche, Edelstahl - Ausgießer mit Deckel
glass bottle, stainless steel spout with lid
botella de vidrio, pico verteder de acero inoxidable con tapa
bouteille en verre, bec verseur en acier inox avec couvercle



	Ø cm	↑ cm	ltr.
40511	7	22	0,35



93308
200 ml

93309

Spritzflasche inklusive Ausgießer

squeeze bottle with nozzle
botella exprimible con dosificador
flacon pulvérisateur avec bec verseur

ideal für Bitter-Liköre, Essig, Öl
perfect for bitter liqueur, vinegar, oil
perfecto para licores amargos, vinagre, aceite
idéal pour liqueur amère, vinaigre, huile



	cm	↑ cm	ltr.
93308	6 x 5	20	0,2

Ausgießer passend für Spritzflasche / nozzle suitable for squeeze bottle / dosificador apto para botella exprimible / bec verseur approprié pour flacon pulvérisateur

	Ø cm	↑ cm
93309	2,5	5,5

NEW



350 ml

Zuckerdosierer „OLD FASHIONED“

sugar dispenser
azucarero
sucrier



Schraubdeckel aus Edelstahl, mit Dosierklappe
cover stainless steel with dosing flap
tapa de acero inoxidable, con cierre dosificador
couvrecl en acier inox, avec couvercle de dosage

	Ø cm	↑ cm	ltr.
40510	7,5	14	0,35



mit Dosierklappe
with dosing flap



300 ml

Zuckerdosierer

sugar dispenser
azucarero
sucrier



Schraubdeckel aus Edelstahl
cover stainless steel
tapa de acero inoxidable
couvrecl en acier inox

	Ø cm	↑ cm	ltr.
00766	8,5	15	0,3

Ersatzglasbehälter / spare glass-container / contenedor de repuesto / récipient verre de rechange

00768



40490
150 ml

Zuckerdosierer

sugar dispenser
azucarero
sucrier



Schraubdeckel aus Edelstahl, mit Dosierrohr
cover stainless steel with dosingtube
tapa de acero inoxidable y tubo dosificador
couvrecl en acier inox et tube doseur

	Ø cm	↑ cm	ltr.
40490	8,5	12	0,15
40494	8,5	15	0,25

Ersatzglasbehälter / spare glass-container / contenedor de repuesto / récipient verre de rechange

fits to

40498	40490
40499	40494



40494
250 ml



Zuckerdosierer

sugar dispenser
azucarero
sucrier



Schraubdeckel aus Edelstahl mattiert, mit Dosierrohr
cover stainless steel matt polished, with dosing tube
tapa de rosca de acero inoxidable mate y tubo dosificador
couvrerle à vis en acier inox mat et tube doseur

	Ø cm	↑ cm	ltr.
40509	6	14,5	0,20



Zuckerdosierer

sugar dispenser
azucarero
sucrier



Schraubdeckel aus Edelstahl, mit Dosierrohr
cover stainless steel, with dosing tube
tapa de acero inoxidable y tubo dosificador
couvrerle en acier inox et tube doseur

	Ø cm	↑ cm	ltr.
40486	8,0	15	0,25
40506	7,5	17	0,32



Allzweckgießer

pourer
dosificador
doseur



Schraubdeckel aus Edelstahl und Kunststoff, mit Dosierklappe
cover stainless steel and plastic, with dosing flap
tapa de acero inoxidable y plástico, con cierre dosificador
couvrerle en acier inox et plastique, avec couvercle de dosage

	Ø cm	↑ cm	ltr.
40488	8	12,5	0,25



Allzweckgießer

pourer
bote vertedor universal
pot verseur universel



für Honig, Kaffeesahne, etc., Schraubdeckel aus Edelstahl
for honey, cream, etc., cover stainless steel
para miel, crema, etc., tapa de acero inoxidable
pour le miel, le lait, la crème, etc., couvercle en acier inox

	Ø cm	↑ cm	ltr.
00765	8,5	13,5	0,3

Ersatzglasbehälter / spare glas-container / contenedor de repuesto / récipient verre de rechange

00768



320 ml

Zuckerdosierer

sugar dispenser
azucarero
sucrier



Schraubdeckel mit Klappe aus Edelstahl, mit Dosierklappe

cover stainless steel, with dosing flap
tapa acero inoxidable, con cierre dosificador
couvreclé inox, avec couvercle doseur

	Ø cm	↑ cm	ltr.
40487	7,5	13,5	0,32



200 ml

Zuckerdosierer

sugar dispenser
azucarero
sucrier

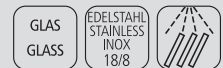

mit Schraubverschluss, Dosier-Rohr Ø 15 mm

cover and dosingtube Ø 15 mm
con tapa y tubo dosificador Ø 15 mm
couvreclé avec tube doseur Ø 15 mm

	Ø cm	↑ cm	ltr.
40508	6,5	14,5	0,20



170 ml

Zuckerspender / Milchkännchen

sugar pourer / milk jug
dispensador de azúcar
sucrier doseur



matt poliert

satín polished finish
pulido efecto satinado
intérieur et extérieur poli mat

	Ø cm	↑ cm	ltr.
10316	5	15	0,17



Zuckerkuigel

sugar pot
azucarero
sucrier



hochglanzpoliert, mit Rolldecke

mirror polished finish, rolltop cover
pulido acabado brillante, tapa abatible
brillant, couvercle abattant

	Ø cm	↑ cm
00033	13,5	15

Tableware . Table Presentation



Butterservierer

butter dish
mantequillera
beurrier



	Ø cm	↑ cm
15925	9	9



Butterservierer

butter dish
mantequillera
beurrier



	cm	↑ cm
15926	9 x 9	9



Butterservierer

butter dish
mantequillera
beurrier



hochglanzpoliert
mirror polished finish
acabado brillante
poli brillant

	Ø cm	↑ cm
15921	9	7



Schale „ENAMELWARE“

bowl
cuenco
bol



	cm	↑ cm
40667	16 x 12,0	3,5
40668	18 x 13,5	4,0



hot price

Kühlschrank-Butterdose

refrigerator butter dish
mantequillera para nevera
boîte à beurre pour le frigo



	cm	↑ cm
00063	16 x 9,5	5,5



Eierbecher

egg holder
huevera
coquetier



	Ø cm	↑ cm
00032	8,5	2

VINTAGE

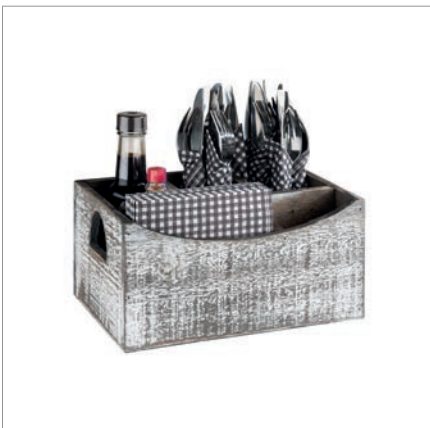

Table Caddy „VINTAGE“
table caddy
caddy de mesa
caddy de table



unterteilt in 5 Fächer
divided into 5 compartments
dividido en 5 compartimentos
divisé en 5 compartiments

	cm	↑ cm
11608	22 x 15,5	11,5



Table Caddy „VINTAGE“
table caddy
caddy de mesa
caddy de table



unterteilt in 7 Fächer
divided into 7 compartments
dividido en 7 compartimentos
divisé en 7 compartiments

	cm	↑ cm
11609	25,5 x 15,5	11,5



Table Caddy „VINTAGE“
table caddy
caddy de mesa
caddy de table



unterteilt in 4 Fächer, mit Tragegriff
divided into 4 compartments, with handle
dividido en 4 compartimentos, con asa
divisé en 4 compartiments, avec poignée

	cm	↑ cm
11610	22 x 15,5	22



Table Caddy „VINTAGE“

table caddy
caddy de mesa
caddy de table



	cm	↑ cm
11612	15 x 15	10
11613	15 x 15	15

	cm	↑ cm
11614	30 x 15	15

GN 1/1 Tablett / GN tray / GN bandeja / GN plateau



	cm	↑ cm	GN
11615	53 x 32,5	5	1/1



Buffettisch „MINI VINTAGE“

buffet stand
soporte para buffet
présentoir buffet



	cm	↑ cm	fits to
11634	40 x 21,5	15	GN 1/3 trays



VINTAGE



Tableware
Table Presentation



Holzbox „VINTAGE“

woodbox
caja madera
base bois



Schubladenoptik, mit Knopf

drawer look, with knob
look cajón, con pomo
look tiroir, avec bouton

	cm	↑ cm	inner size cm
11631	18,5 x 18,5	11	17 x 17, mit Beschriftungsfach
11630	11,5 x 7,5	5	10 x 6



Holzbox „VINTAGE“

woodbox
caja madera
base bois



Schubladenoptik, mit Knopf

drawer look, with knob
look cajón, con pomo
look tiroir, avec bouton

	cm	↑ cm	inner size cm
11633	18,5 x 18,5	11	17 x 17, mit Beschriftungsfach
11632	11,5 x 7,5	5	10 x 6

Tableware . Table Presentation



Table Caddy „VINTAGE“

table caddy
caddy de mesa
caddy de table



herausnehmbare Aufteilung, 4-Fächer (7 x 7 cm)
separation removable, 4 compartments (7 x 7 cm)
separadores amovibles, 4 compartimentos (7 x 7 cm)
séparateurs amovibles, 4 compartiments (7 x 7 cm)

	cm	↑ cm	Farbe / Colour
11635	17 x 17	10	White
11636	17 x 17	10	Blue
11637	17 x 17	10	Yellow



Table Caddy „VINTAGE“

table caddy
caddy de mesa
caddy de table



herausnehmbare Aufteilung, 4-Fächer (7 x 7 cm)
separation removable, 4 compartments (7 x 7 cm)
separadores amovibles, 4 compartimentos (7 x 7 cm)
séparateurs amovibles, 4 compartiments (7 x 7 cm)

	cm	↑ cm	Farbe / Colour
11600	17 x 17	16	White
11601	17 x 17	16	Blue
11602	17 x 17	16	Yellow



Table Caddy „VINTAGE“

table caddy
caddy de mesa
caddy de table



herausnehmbare Aufteilung, 6 Fächer (7,5 x 7,5 cm)
separation removable, 6 compartments (7,5 x 7,5 cm)
separadores amovibles, 6 compartimentos (7,5 x 7,5 cm)
séparateurs amovibles, 6 compartiments (7,5 x 7,5 cm)

	cm	↑ cm	Farbe / Colour
11638	27 x 17	10	White
11639	27 x 17	10	Blue
11640	27 x 17	10	Yellow



Table Caddy „VINTAGE“

table caddy
caddy de mesa
caddy de table



herausnehmbare Aufteilung, 6 Fächer (7,5 x 7,5 cm)
separation removable, 6 compartments (7,5 x 7,5 cm)
separadores amovibles, 6 compartimentos (7,5 x 7,5 cm)
séparateurs amovibles, 6 compartiments (7,5 x 7,5 cm)

	cm	↑ cm	Farbe / Colour
11603	27 x 17	16	White
11604	27 x 17	16	Blue
11605	27 x 17	16	Yellow

NEW



40403



30355



30356

Table Caddy „ACACIA“

table caddy
caddy de mesa
caddy de table

HOLZ
WOOD



Akazienholz, 3-Fächer

Fach 1+3: 11,5 x 5,5 cm / Fach 2: 12,0 x 11,5 cm

acacia wood, 3 compartments

compartment 1+3: 11,5 x 5,5 cm / compartment 2: 12,0 x 11,5 cm

madera de acacia, 3 compartimentos

compartimento 1+3: 11,5 x 5,5 cm / compartimento 2: 12,0 x 11,5 cm

bois d'acacia, 3 compartiments

compartiments 1+3: 11,5 x 5,5 cm / compartiment 2: 12,0 x 11,5 cm

	cm	↑ cm
40403	27,5 x 13,5	24

passende Brottasche / suitable bread basket / panera a juego / corbeille assortie

	cm	↑ cm	Farbe / Colour
30355	12 x 11,5	11,5	
30356	12 x 11,5	11,5	



Table Caddy

table caddy
caddy de mesa
caddy de table

HOLZ
WOOD



Akazienholz, 2-Fächer

acacia wood, 2 compartements

madera de acacia, 2 compartimentos

bois d'acacia, 2 compartiments

	cm	↑ cm	inner size cm
40405	25 x 15	18	21,5 x 8



Table Caddy „VINTAGE“

table caddy
caddy de mesa
caddy de table

HOLZ
WOOD



Holz, 2-Fächer (13,5 x 6 cm)

2 compartments (13,5 x 6 cm)

2 compartimentos (13,5 x 6 cm)

2 compartiments (13,5 x 6 cm)

	cm	↑ cm	inner size cm
40404	15,5 x 15,5	15	13,5 x 6



Holzbox „WOODY“

woodbox
caja madera
base bois

HOLZ
WOOD



Akazienholz, 4-Fächer

acacia wood, 4 compartements

madera de acacia, 4 compartimentos

bois d'acacia, 4 compartiments

	cm	↑ cm	inner size cm
11649	36 x 14	12,5	12,5 x 8

Tableware . Table Presentation



Holzbox „TABLE“

woodbox
caja madera
base bois



Akazienholz, 3 Fächer (6,5 x 6,5 cm)

acacia wood, 3 compartments (6,5 x 6,5 cm)
madera de acacia, 3 compartimentos (6,5 x 6,5 cm)
bois d'acacia, 3 compartiments (6,5 x 6,5 cm)

	cm	↑ cm	inner size cm	€
11727	23,5 x 8,5	4,5	6,5 x 6,5 je Fach / each compartment	12,00



Holzbox „VINTAGE“

woodbox
caja madera
base bois



Akazienholz, vintage weiß

acacia wood, vintage white
madera de acacia, blanca vintage
bois d'acacia, blanc vintage

	cm	↑ cm	inner size cm
11725	15,0 x 9,5	5	12 x 6,5



Holzbox „TABLE“

woodbox
caja madera
base bois



Akazienholz natur

acacia wood nature
madera de acacia natural
bois d'acacia naturel

	cm	↑ cm	inner size cm
11726	15,0 x 9,5	5	12 x 6,5



Table Caddy

table caddy
caddy de mesa
caddy de table



Akazienholz

acacia wood
madera de acacia
bois d'acacia

	cm	↑ cm	inner size cm
11625	23 x 10	10	22,5 x 6



Holzbox „WOODY“

woodbox
caja madera
base bois



Akazienholz

acacia wood
madera de acacia
bois d'acacia

	cm	↑ cm	inner size cm
11650	15,0 x 15	5,5	13 x 13
11651	22,5 x 15	5,5	13,5 x 13 / 6,5 x 13



Servierbrett „NARROW“

serving board
tabla de servir
planche de service



Akazienholz, mit 3 Vertiefungen Ø 6 cm
acacia wood, with 3 notches Ø 6 cm
madera de acacia, con 3 ranuras Ø 6 cm
bois d'acacia, avec 3 encoches Ø 6 cm

	cm	↑ cm
00878	31 x 11	2



passende Schälchen / fitting bowls / cuencos adecuados / bols apropiés

	Ø cm	↑ cm	ltr.	
40685	6	3	0,05	stainless steel
82316	7	8	0,22	glas



Besteckbehälter „TIN“

cutlery bin
recipiente
réipient



Behälter aus Metall mit Tragegriff aus Holz
container made of metal with wooden handle
contenedor de metal con asa de madera
conteneur métallique avec poignée en bois

	cm	↑ cm
00014	24,5 x 12	18,5



Table Caddy „ELEMENT“

table caddy
caddy de mesa
caddy de table



Beton, mit möbelschonender Unterseite
concrete, furniture-friendly underside
hormigón, con base anti rayaduras
béton, avec revêtement antirayures

	cm	↑ cm	inner size cm
11647	16,5 x 16	6,5	14,5 x 14



Table Caddy „ELEMENT“

table caddy
caddy de mesa
caddy de table



Beton, mit möbelschonender Unterseite, 2 Löcher je 6,5 cm
concrete, furniture-friendly underside, 2 holes each 6.5 cm
hormigón, con base anti rayaduras, 2 agujeros cada uno 6,5 cm
béton, avec revêtement antirayures, 2 trous de 6,5 cm chacun

	cm	↑ cm	inner size cm
11648	23,5 x 16	6,5	14,5 x 14

Tableware . Table Presentation



Kerzenleuchter „XXL“

candle holder
candelabro
chandelier



5-flammig, Zinkdruckguss, vernickelt, schwere Ausführung, einfache Montage
5 branches, zinc alloy nickel-plated, heavy model, easy to assemble
5 ramas, fundición de aleación de zinc niquelada, alta calidad y fácil montaje
5 branches, fonte d'alliage de zinc nickelée, haute qualité, facile à monter

	cm	↑ cm	
04000	46 x 46	56	5-flammig / 5-lids / 5 ramas / 5 branches
04012	46 x 46	78	5-flammig / 5-lids / 5 ramas / 5 branches



Kerzenleuchter

candle holder
candelabro
chandelier



hochwertige Gastro Ausführung, möbelschonende Unterseite
heavy quality, with non-scratching undersurface
alta calidad, con base anti raya duras
haute qualité, avec revêtement antirayures

	cm	↑ cm	
04001	27,5 x 27,5	25	5-flammig / 5-lids / 5 ramas / 5 branches
04002	27,5 x 11,0	25	3-flammig / 3-lids / 3 ramas / 3 branches
	Ø cm	↑ cm	
04003	11	22	1-flammig / 1 lid / 1 rama / 1 branche
04004	11	10	1-flammig / 1 lid / 1 rama / 1 branche



Kerzenleuchter „CLASSIC“, 2er Set

candle holder, 2 pcs. set
candelabros, set de 2
chandeliers, set de 2



möbelschonende Unterseite
with non-scratching undersurface
con base anti rayaduras
avec revêtement antirayures

	Ø cm	↑ cm	pcs.
04035	10	20,5	2



Kerzenleuchter „CLASSIC“

candle holder
candelabro
chandelier



möbelschonende Unterseite
with non-scratching undersurface
con base anti rayaduras
avec revêtement antirayures

	cm	↑ cm	
04036	22 x 10	22,5	3-flammig / 3-lids / 3 ramas / 3 branches



Kerzenleuchter „CLASSIC“

candle holder
candelabros
chandelier



möbelschonende Unterseite
with non-scratching undersurface
con base anti rayaduras
avec revêtement antirayures

	cm	↑ cm	
04037	22 x 22	24	5-flammig / 5-lids / 5 ramas / 5 branches



Kerzenleuchter „XL“

candle holder
candelabro
grand chandelier



extra hoch und schwer, möbelschonende Unterseite
extra high and heavy, with non-scratching undersurface
pesado y de alta calidad, con base anti rayaduras
lourd et de haute qualité, avec revêtement antirayures

	cm	↑ cm	
04005	35 x 13	39	3-flammig / 3-lids / 3 ramas / 3 branches



Kerzenleuchter „XL“

candle holder
candelabro
grand chandelier



extra hoch und schwer, möbelschonende Unterseite
extra high and heavy, with non-scratching undersurface
pesado y de alta calidad, con base anti rayaduras
lourd et de haute qualité, avec revêtement antirayures

	cm	↑ cm	
04006	35 x 35	39	5-flammig / 5-lids / 5 ramas / 5 branches



Kerzenleuchter, 2er Set

candle holder, 2 pcs. set
candelabros, set de 2
chandeliers, set de 2



möbelschonende Unterseite
with non-scratching undersurface
con base anti rayaduras
avec revêtement antirayures

	Ø cm	↑ cm	pcs.
04008	6	7	2



Kerzenleuchter

candle holder
candelabro
chandelier



extra schwerer Fuß, verchromt, möbelschonende Unterseite
heavy foot, chrome plated, with non-scratching undersurface
pie pesado, asa cromado, con base anti rayaduras
pied lourd, chromé, avec revêtement antirayures

	Ø cm	↑ cm	Farbe / Colour
04020	10	11	
04021	10	16	



Kerzenleuchter

candle holder
candelabro
chandelier



Metall hartverchromt, 1-flammig, standsichere Ausführung
hard chrome plated metal, 1 lid, heavy stable quality
metal duro cromado, 1 brazo, construcción estable
metal chromé dur, 1 flamme, stable

	Ø cm	↑ cm
04030	9,5	10
04031	9,5	16



Kerzenleuchter „ELEMENT“

candle holder
candelabro
chandelier



Beton, mit möbelschonender Unterseite
concrete, furniture-friendly underside
hormigón, con base anti rayaduras
béton, avec revêtement antirayures

	Ø cm	↑ cm
04027	10	14,5



Windlichter, 2er Set

wind lights, 2 pcs. set
portavelas antiviento, set de 2
porte-bougies anti-vent, set de 2



matt poliert, Gläser satiniert, möbelschonende Unterseite
satin polished finish, glasses satin, with non-scratching undersurface
pulido acabado efecto satinado, cristales satinados, con base anti rayaduras
inox mat satiné et verre mat, avec revêtement antirayures

	Ø cm	↑ cm	pcs.
03020	5	15	2

Ersatzglas / spare glass / cristal de recambio / verre de rechange

03025



Windlichter „ELEMENT“, 2er Set

wind lights, 2 pcs. set
portavelas antiviento, set de 2
porte-bougies anti-vent, set de 2



Beton, Gläser klar, mit möbelschonender Unterseite
concrete, glass clear, with non-scratching undersurface
hormigón, vidrio transparente, con base anti rayaduras
bèton, verre transparente, avec revêtement antirayures

	Ø cm	↑ cm	pcs.
03038	6	8	2

Ersatzglas / spare glass / vidrio de recambio solo / verre de rechange transparent, seul

	Ø cm	↑ cm
03098	6	5



Windlicht „ELEMENT“

wind light
porta vela
porte-bougie



Beton, Glas klar, mit möbelschonender Unterseite
concrete, glass clear, with non-scratching undersurface
hormigón, vidrio transparente, con base anti rayaduras
bèton, verre transparente, avec revêtement antirayures

	Ø cm	↑ cm
03039	7,5	13

Ersatzglas / spare glass / vidrio de recambio solo / verre de rechange transparent, seul

	Ø cm	↑ cm
03099	7,5	9



Windlicht / Tischleuchte

wind light
porta velas
porte-bougie de table, anti-vent



möbelschonende Unterseite
with non-scratching undersurface
con base anti rayaduras
avec revêtement antirayures

	Ø cm	↑ cm
03013	11	22

Ersatzglas / spare glass / vidrio de recambio solo / verre de rechange transparent, seul

03015



Vase mit Glaseinsatz „ELEMENT“

flower vase with glass insert
 florero con tubo de cristal
 vase soliflor avec verre



Beton, Glas klar, mit möbelschonender Unterseite, inkl. 2 Ersatzgläsern
 concrete, clear glass, furniture-friendly underside, incl. 2 spare glasses
 hormigón, cristal incoloro, con base anti rayaduras, incl. 2 tubos de repuesto
 béton, verre transparente avec revêtement antirayures y compris 2 verres de rechange

	cm	↑ cm	ml
04010	10 x 4,5	12,5	25

Ersatzglas / spare glass / tubo de recambio / verre de rechange

	Ø cm	↑ cm	ml
04011	2,5	11	25



Vase

flower vase
 florero
 vase soliflor



Edelstahl-Look, Zinkdruckguss, vernickelt, lackiert, anlaufgeschützt, schwere Ausführung
 stainless steel look, heavy zink alloy, nickel plated, laquered
 aspecto acero, acabado satinado, alta calidad
 aspect inox, fini mat satiné, bonne qualité

	Ø cm	↑ cm	kg
04015	4,0	16,5	0,17
04016	4,5	20,0	0,20



Vase

flower vase
 florero
 vase soliflor



Edelstahl-Look, Zinkdruckguss, vernickelt, lackiert, anlaufgeschützt, schwere Ausführung
 stainless steel look, heavy zink alloy, nickel plated, laquered
 aspecto acero, acabado satinado, alta calidad
 aspect inox, fini mat satiné, bonne qualité

	Ø cm	↑ cm	kg
04017	6,5	18	0,36

Tischsets



Die umgelegten und angenähten Kanten machen diese Tischsets besonders robust. Geliefert in einer 6er Einheit.

The folded and sewn edges make these table sets particularly robust. Delivered in a packing unit of 6 pieces.

Los bordes doblados y cosidos des los mantelitos los hacen especialmente resistentes. Se entregan en una unidad de embalaje de 6 piezas.

Les bords repliés et cousus rendent ces sets de table en particulièrement robustes. Livré dans un emballage de 6 pièces.



Warenträger - Tischsets

display for table sets
expositor para mantelinas de mesa
présentoir pour sets de table

12 Einschubfächer, komplett auf Rollen, 2 Feststellrollen, Lieferung demontiert

12 shelves, on rolls, 2 rolls to fix, delivery unassembled
12 niveles, 4 ruedas, desmontado (montaje fácil)
12 niveaux, 4 roues, livré démonté

	cm	↑ cm
00401	39,5 x 45	165



60037 - gold

Tischset Feinband

placemat fine band
mantelín cinta fina
set de table, tressage fin



	cm		VE / unit
60037	45 x 33	gold / gold	6
60038	45 x 33	beige braun / beige brown	6
60040	45 x 33	blau / blue	6

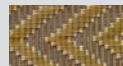

60037 - gold

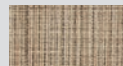

60038 - beige brown



60040 - blue



60502 - grey, beige

Tischset Feinband „TAO“

placemat fine band
mantelín cinta fina
set de table, tressage fin



	cm		VE / unit
60502	45 x 33	grau, beige / grey, beige	6
60503	45 x 33	beige / beige	6
60505	45 x 33	braun / brown	6



60502 - grey, beige



60503 - beige



60505 - brown

Tableware . Table Presentation



Tischset „KUNSTLEDER“

placemat
mantelín
set de table



Kunstleder
imitation leather
imitación de cuero
similicuir

	cm		VE / unit
60044	45 x 32,5	grau / grey	6
60045	45 x 32,5	braun / brown	6
60046	45 x 32,5	schwarz / black	6



60044 - grey 60045 - brown 60046 - black mit Naht rundherum

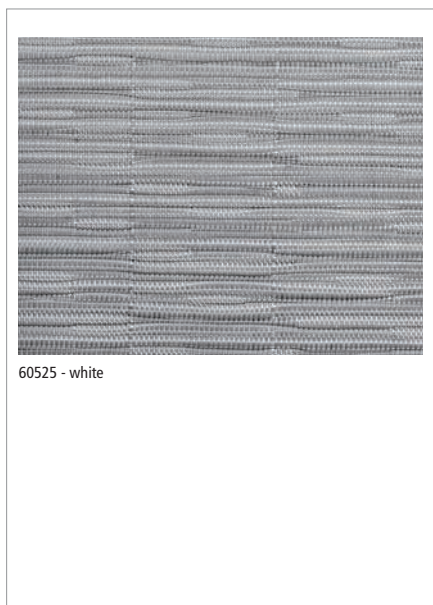

Tischset Schmalband

placemat smallband
mantelín cinta estrecha
set de table tressage étroit



	cm		VE / unit
60525	45 x 33	weiß / white /	6
60526	45 x 33	gold / gold /	6
60527	45 x 33	silber / silver /	6
60528	45 x 33	grün / green /	6

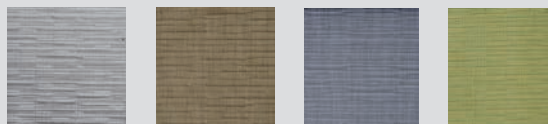

60525 - white 60526 - gold 60527 - silver 60528 - green

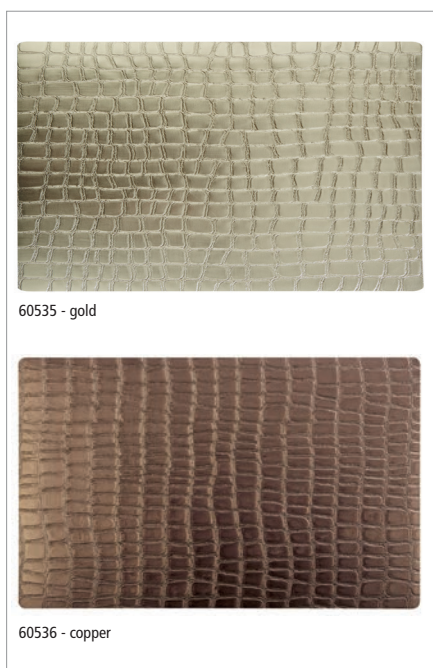

Tischset „CROCO“

placemat
mantelín
set de table



rutschhemmende Unterseite
slip resistant underside
antideslizante por debajo
dessous antiglisse

	cm		VE / unit
60535	45 x 30	gold / gold	6
60536	45 x 30	kupfer / copper	6
60537	45 x 30	braun / brown	6

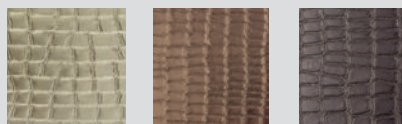

60535 - gold 60536 - copper 60537 - brown

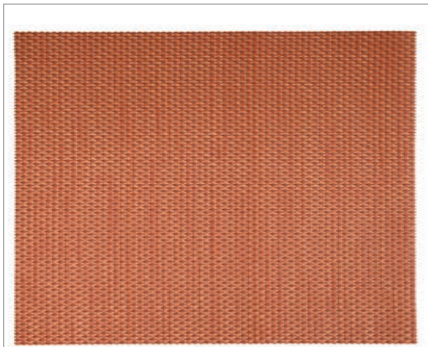

60018 - candyred

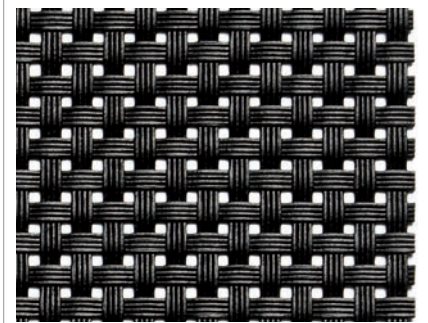

60012 - black

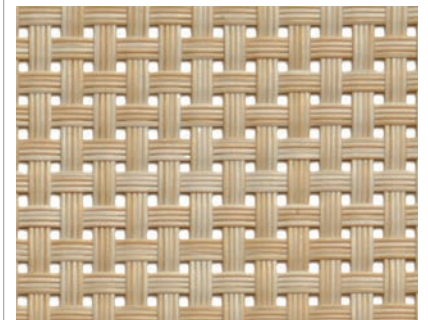

60014 - beige

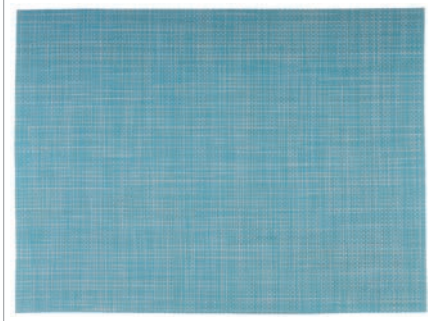

60041 - light blue, white



60042 - turquoise, green, white

Tischset Schmalband
placemat smallband
mantelín cinta estrecha
set de table tressage étroit



	cm		VE / unit
60002	45 x 33	hellblau / light blue	6
60018	45 x 33	candyrot / candyred	6
60012	45 x 33	schwarz / black	6
60014	45 x 33	beige / beige	6
60015	45 x 33	silbergrau / silvergrey	6
60016	45 x 33	grün / green	6
60019	45 x 33	beige braun / beige brown	6
60522	45 x 33	hellorange / light orange	6
60520	45 x 33	schwarz weiß / black white	6
60521	45 x 33	apfelgrün / apple green	6
60523	45 x 33	violett / purple	6
60524	45 x 33	platin / platinum	6
60041	45 x 33	hellblau, weiß / light blue, white	6



60041 - light blue, white

Tischset Feinband
placemat fine band
mantelín cinta fina
set de table, tressage fin



	cm		VE / unit
60042	45 x 33	türkis, grün, weiß / turquoise, green, white	6
60509	45 x 33	Mosaik schwarz, grau / black, grey	6
60512	45 x 33	schwarz, grau / black, grey	6
60542	45 x 33	rot / red	6

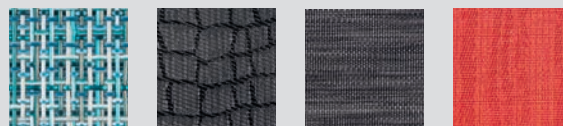

60042 - turquoise, green, white

Tableware . Table Presentation

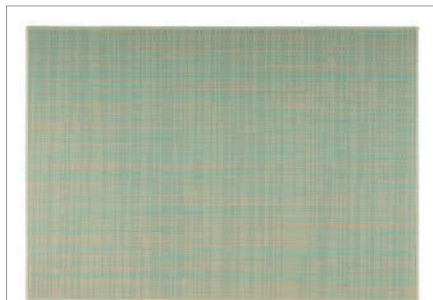

60506 - beige, turquoise



60507 - yellow, light blue

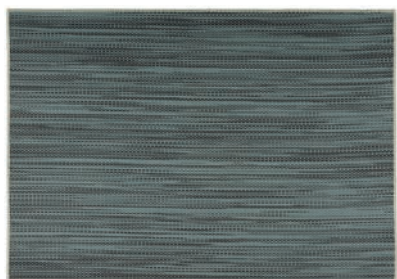

60508 - light blue, dark blue

Tischset Feinband „TAO“

placemat fine band
mantelín cinta fina
set de table, tressage fin



	cm		VE / unit
60506	45 x 33	beige, türkis / beige, turquoise	6
60507	45 x 33	gelb, hellblau / yellow, light blue	6
60508	45 x 33	hellblau, dunkelblau / light blue, dark blue	6



60506 - beige, turquoise



60507 - yellow, light blue

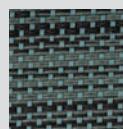

60508 - light blue, dark blue

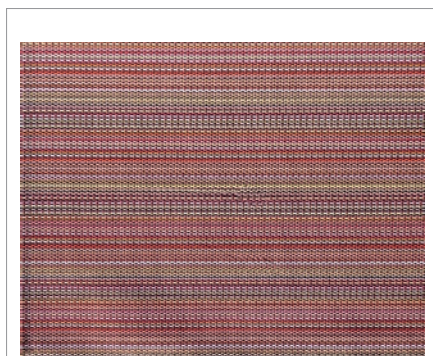

60510 - LINES orange red



60511 - LINES orange, yellow

Tischset Feinband

placemat fine band
mantelín cinta fina
set de table, tressage fin



	cm		VE / unit
60510	45 x 33	LINES orange, rot / LINES orange red	6
60511	45 x 33	LINES orange, gelb / LINES orange yellow	6
60531	45 x 33	LINES schwarz / LINES black	6
60532	45 x 33	LINES pastell / LINES pastell	6
60533	45 x 33	LINES bordeaux / LINES bordeaux	6
60534	45 x 33	LINES rot / LINES red	6
60530	45 x 33	STRIPES grau / STRIPES grey	6
60540	45 x 33	FRAMES grau / FRAMES grey	6
60541	45 x 33	FRAMES schwarz / FRAMES black	6



60510 - LINES orange red



60511 - LINES orange, yellow

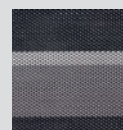

60531 - LINES black

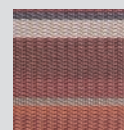

60532 - LINES pastell

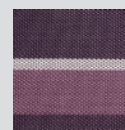

60533 - LINES bordeaux

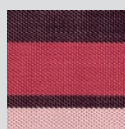

60534 - LINES red

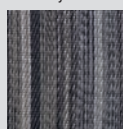

60530 - LINES grey

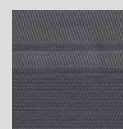

60540 - FRAMES grey

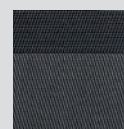

60541 - FRAMES black

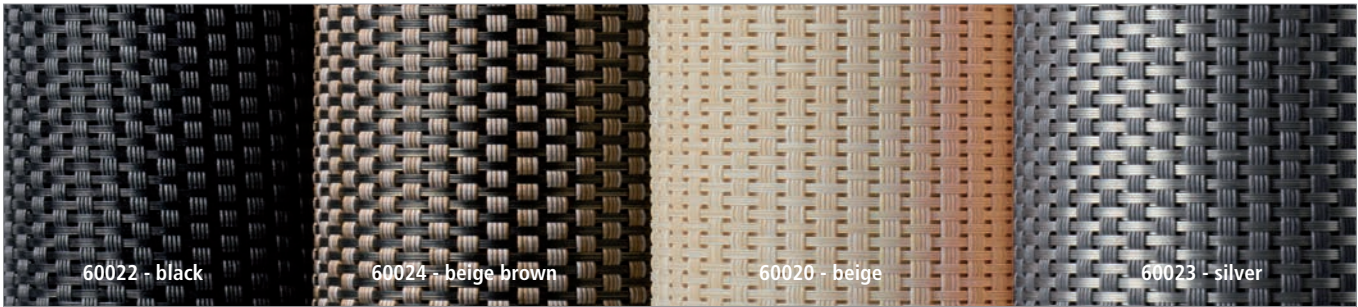

Schmalband Tischläufer

table runner fine fabric
camino de mesa
chemin de table

pflegeleichtes Kunststoffgeflecht
easy to clean
fácil de limpiar
nettoyage aisé



	cm	
60022	45 x 150	schwarz / black
60024	45 x 150	beige, braun / beige, brown
60020	45 x 150	beige / beige
60023	45 x 150	silbergrau / silver grey



Servietten- und Bestecktaschen, 6er Set

cutlery bag, 6 pcs. set
bolsa cubiertos, set de 6
pochette couverts, set de 6



	cm		pcs.
60551	24 x 9	silbergrau / silvergrey	6
60550	24 x 9	beige / beige	6
60552	24 x 9	beige braun / beige brown	6
60554	24 x 9	platin / platinum	6



60550 - beige

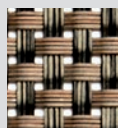

60552 - beige/braun

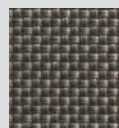

60554 - platin





Körbe

baskets
cestas
corbeilles

SUPERSTRONG



GN 1/1 Korb „SUPERSTRONG“

GN 1/1 basket
GN 1/1 cesta
GN 1/1 corbeille



	cm	↑ cm	GN	Farbe / Colour
50640	53 x 32,5	6,5	1/1	
50641	53 x 32,5	10,0	1/1	
50642	53 x 32,5	15,0	1/1	
50643	53 x 32,5	6,5	1/1	
50644	53 x 32,5	10,0	1/1	
50645	53 x 32,5	15,0	1/1	

GN Kuppelhaube / GN cover / GN cúpula / GN cloche bombée

	cm	↑ cm	GN
11027	54 x 33	20	1/1

GN Abdeckhaube / GN cover / GN cubierta / GN cloche

	cm	↑ cm	GN
11042	53 x 32,5	9,5	1/1

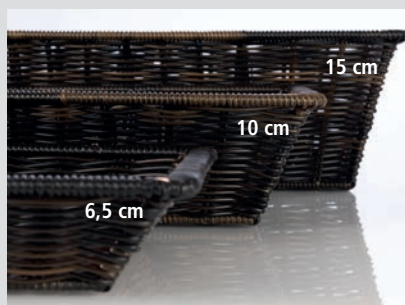

PROFI LINE



Korb "PROFI LINE"
basket baker size
cesta tamaño panaderia
corbeille dimensions „boul-pâte“



	cm	↑ cm	Farbe / Colour
50714	30 x 20	5	
50900	40 x 20	5	
50901	40 x 20	5	
50902	40 x 20	5	
50903	40 x 20	5	



Korb "PROFI LINE"
basket baker size
cesta tamaño panaderia
corbeille dimensions „boul-pâte“



	cm	↑ cm	Farbe / Colour
50905	40 x 30	5	
50906	40 x 30	5	
50907	40 x 30	5	
50908	40 x 30	5	
	cm	↑ cm	Farbe / Colour
50710	40 x 30	10	
50711	40 x 30	10	
50713	40 x 30	10	
50712	40 x 30	10	



Korb "PROFI LINE"
basket baker size
cesta tamaño panaderia
corbeille dimensions „boul-pâte“



	cm	↑ cm	Farbe / Colour
50910	60 x 20	5	
50911	60 x 20	5	
50912	60 x 20	5	
50913	60 x 20	5	

Körbe

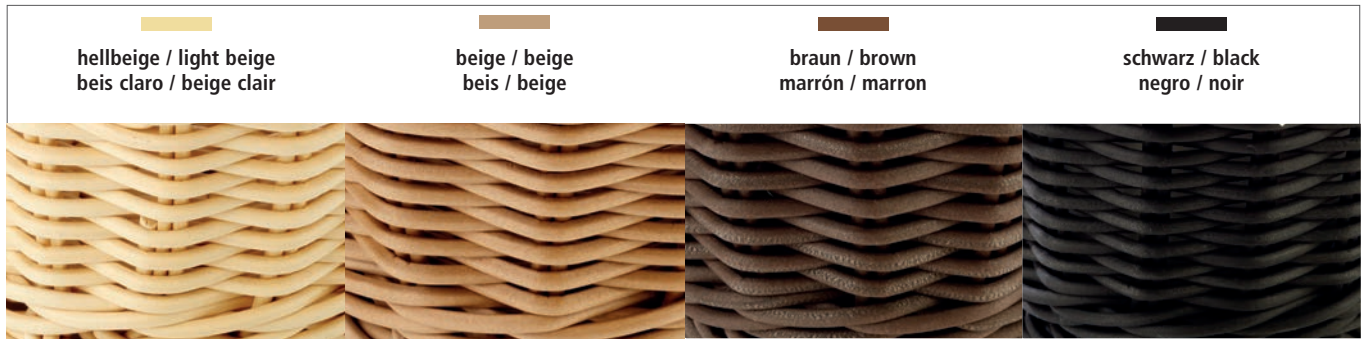

hellbeige / light beige
beis claro / beige clair

beige / beige
beis / beige

braun / brown
marrón / marron

schwarz / black
negro / noir



Korb "PROFI LINE"

basket baker size
cesta tamaño panaderia
corbeille dimensions „boul-pâte“



	cm	↑ cm	Farbe / Colour
50915	60 x 40	5	hellbeige
50916	60 x 40	5	beige
50917	60 x 40	5	braun
50918	60 x 40	5	schwarz



GN 1/1 Korb „PROFI LINE“

GN 1/1 basket
GN 1/1 cesta
GN 1/1 corbeille



	cm	↑ cm	Farbe / Colour
50720	53 x 32,5	10	hellbeige
50721	53 x 32,5	10	beige
50723	53 x 32,5	10	braun
50722	53 x 32,5	10	schwarz



Korb, rechteckig „PROFI LINE“

basket, rectangular
cesta, rectangular
corbeille, rectangulaire



	cm	↑ cm	Farbe / Colour
50700	26,5 x 19	7	hellbeige
50701	26,5 x 19	7	beige
50703	26,5 x 19	7	braun
50702	26,5 x 19	7	schwarz

	cm	↑ cm	Farbe / Colour
50705	31 x 21	9	hellbeige
50706	31 x 21	9	beige
50708	31 x 21	9	braun
50707	31 x 21	9	schwarz



Brötchenschütte „PROFI LINE“

roll / bun basket
cesta para bollos
corbeille à petits pains



	cm	↑ cm
50510	60 x 40	60



Stangenbrotkorb „PROFI LINE“

baguette basket
cesta de baguette
corbeille à baguettes



	Ø cm	↑ cm	Farbe / Colour
50500	28 / 30	38	Yellow
50501	28 / 30	38	Brown



Auslage Tablett flach „PROFI LINE“

display tray flat, baker size
bandeja de presentación, tamaño panadería
plateau de présentation, dimensions „boul-pâte“



	cm	↑ cm
40296	40 x 30	1
40297	60 x 40	1

Körbe



Korb, rund „PROFI LINE“

basket, round
cesta redonda
corbeille ronde



	∅ cm	↑ cm
50210	37	9
50215	42	12



Korb, rund „PROFI LINE“

basket, round
cesta redonda
corbeille ronde



	∅ cm	↑ cm
50205	31 / 37	12 / 6



Korbschütte, rund „PROFI LINE“

basket, round
cesta redonda
corbeille ronde



	∅ cm	↑ cm
50100	36,5	12,0
50105	42,0	18,5
50110	46,0	18,5



Systemkorb, gestäbt „PROFI LINE“

basket
cesta
corbeille



	cm	↑ cm
50300	30 x 40	27 / 16
50305	45 x 40	27 / 16
50310	60 x 40	27 / 16



Systemkorb „PROFI LINE“

basket
cesta
corbeille



	cm	↑ cm
50400	40 x 50	25 / 14



Trenner „PROFI LINE“

divider
divisor
paroi de séparation



	↑ cm	→ cm
50315	26 / 15	38



Baguette Korb, oval „PROFI LINE“

baguette basket, oval
cesta de baguette, oval
corbeille à baguettes, ovale



	cm	↑ cm	Farbe / Colour
50805	28 x 16	8	
50806	28 x 16	8	
50808	28 x 16	8	
50807	28 x 16	8	

	cm	↑ cm	Farbe / Colour
50823	40 x 16	8	



Korb, oval „PROFI LINE“

basket, oval
cesta oval
corbeille ovale



	cm	↑ cm	Farbe / Colour
50800	25 x 19	6,5	
50801	25 x 19	6,5	
50803	25 x 19	6,5	
50802	25 x 19	6,5	

	cm	↑ cm	Farbe / Colour
50815	32 x 23	7	
50816	32 x 23	7	
50818	32 x 23	7	
50817	32 x 23	7	



Korb, rund „PROFI LINE“

basket, round
cesta redonda
corbeille ronde



	Ø cm	↑ cm	Farbe / Colour
50600	16	8	
50601	16	8	
50603	16	8	
50602	16	8	

	Ø cm	↑ cm	Farbe / Colour
50605	20	8	
50606	20	8	
50608	20	8	
50607	20	8	

	Ø cm	↑ cm	Farbe / Colour
50610	29	7	
50611	29	7	
50613	29	7	
50612	29	7	

Körbe



50624

Korb, oval „PROFI LINE“

basket, oval
cesta, oval
corbeille, ovale



	cm	↑ cm	Farbe / Colour
50624	19 x 12	6	
50625	19 x 12	6	
50627	19 x 12	6	
50626	19 x 12	6	



50633



50629

Korb, rechteckig „PROFI LINE“

basket, rectangular
cesta rectangular
corbeille rectangulaire



	cm	↑ cm	Farbe / Colour
50632	17 x 11	9	
50633	17 x 11	9	
50635	17 x 11	9	
50634	17 x 11	9	

	cm	↑ cm	Farbe / Colour
50628	19 x 13	6	
50629	19 x 13	6	
50631	19 x 13	6	
50630	19 x 13	6	



50620

50621

50623

50622

Korb, rund „PROFI LINE“

basket, round
cesta, redonda
corbeille, ronde



	Ø cm	↑ cm	Farbe / Colour
50620	13	10	
50621	13	10	
50623	13	10	
50622	13	10	

GN LINE



2 Höhen - 6,5 und 10 cm
2 heights - 6,5 and 10 cm



40293
GN 1/1 - 10 cm



40292
GN 1/2 - 10 cm

40225
GN 1/4 - 6,5 cm

Korb „GN LINE“

GN basket
GN cesta
GN corbeille



stabile Ausführung mit Edelstahldraht im Rand zur Stabilisierung
very solid with stainless steel wire frame to stabilize the basket
muy resistente con refuerzo de alambre inox
très résistante avec son fil de renfort inox

	cm	↑ cm	GN	Farbe / Colour
40291	53,0 x 32,5	6,5	1/1	
40290	32,5 x 26,5	6,5	1/2	
40223	32,5 x 17,6	6,5	1/3	
40225	26,5 x 16,2	6,5	1/4	
40227	17,6 x 16,2	6,5	1/6	
40229	32,5 x 35,4	6,5	2/3	

	cm	↑ cm	GN	Farbe / Colour
40293	53,0 x 32,5	10,0	1/1	
40292	32,5 x 26,5	10,0	1/2	
40243	32,5 x 17,6	10,0	1/3	
40245	26,5 x 16,2	10,0	1/4	
40247	17,6 x 16,2	10,0	1/6	
40249	32,5 x 35,4	10,0	2/3	



GN 1/1

GN 1/1 Besteckbehälter

GN 1/1 dispenser GN
GN 1/1 dispensador de cubiertos
GN 1/1 bac à couverts



in Handarbeit geflochten, 4 Mulden, Kunststoff-Geflecht, Drahtgestell, braun-schwarz
wickerwork, 4 compartments, with reinforced chromed wire structure, brown-black
cesta trensada a mano, 4 compartimentos, de plástico, con bastidor cromado reforzado, marrón oscuro
corbeille tressée à main, 4 compartiments, en plastique, cadre acier chromé renforcé, couleur marron foncé

	cm	↑ cm	GN	Farbe / Colour
11966	53 x 32,5	9	1/1	

GN LINE

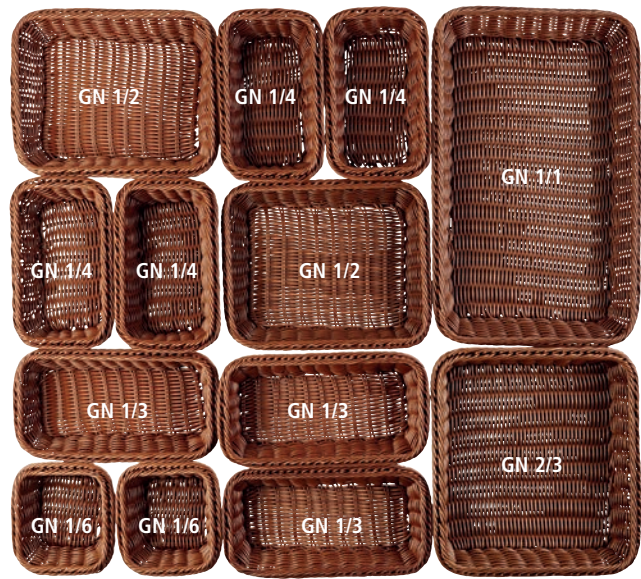
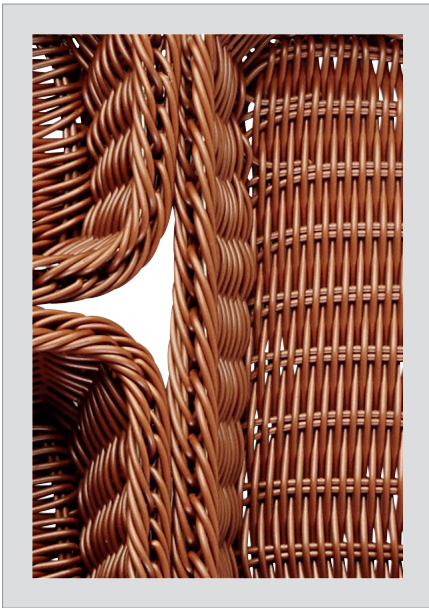

Korb „GN LINE“

GN basket
GN cesta
GN corbeille



stabile Ausführung mit Edelstahldraht im Rand zur Stabilisierung
very solid with stainless steel wire frame to stabilize the basket
muy resistente con refuerzo de alambre inox
très résistante avec son fil de renfort inox

	cm	↑ cm	GN	Farbe / Colour
40220	53,0 x 32,5	6,5	1/1	■
40222	32,5 x 26,5	6,5	1/2	■
40224	32,5 x 17,6	6,5	1/3	■
40226	26,5 x 16,2	6,5	1/4	■
40228	17,6 x 16,2	6,5	1/6	■
40230	32,5 x 35,4	6,5	2/3	■

	cm	↑ cm	GN	Farbe / Colour
40240	53,0 x 32,5	10	1/1	■
40242	32,5 x 26,5	10	1/2	■
40244	32,5 x 17,6	10	1/3	■
40246	26,5 x 16,2	10	1/4	■
40248	17,6 x 16,2	10	1/6	■
40250	32,5 x 35,4	10	2/3	■

	cm	↑ cm	GN	Farbe / Colour
40260	53,0 x 32,5	6,5	1/1	■
40262	32,5 x 26,5	6,5	1/2	■
40263	32,5 x 17,6	6,5	1/3	■
40264	26,5 x 16,2	6,5	1/4	■
40266	17,6 x 16,2	6,5	1/6	■
40268	32,5 x 35,4	6,5	2/3	■

	cm	↑ cm	GN	Farbe / Colour
40270	53,0 x 32,5	10	1/1	■
40272	32,5 x 26,5	10	1/2	■
40274	32,5 x 17,6	10	1/3	■
40276	26,5 x 16,2	10	1/4	■
40278	17,6 x 16,2	10	1/6	■
40280	32,5 x 35,4	10	2/3	■

ECONOMIC



Tisch- und Buffetkorb, rund „ECONOMIC“

buffet basket, round
cesta de buffet, redonda
corbeille de buffet, ronde



	Ø cm	↑ cm	Farbe / Colour
40132	19,0	9,5	
40135	25,5	8,5	
40144	39,0	10,0	
40191	19,0	9,5	
40192	25,5	8,5	



Tisch- und Buffetkorb, oval „ECONOMIC“

buffet basket, oval
cesta de buffet, oval
corbeille de buffet, ovale



	cm	↑ cm	Farbe / Colour
40137	23,0 x 17	8,0	
40139	28,5 x 17	8,5	
40193	23,0 x 17	8,0	
40194	28,5 x 17	8,5	



Tisch- und Buffetkorb, eckig „ECONOMIC“

buffet basket, rectangular
cesta de buffet, rectangular
corbeille de buffet, rectangulaire



	cm	↑ cm	Farbe / Colour
40140	23,0 x 17	8	
40159	31,5 x 22	8,5	
40195	23,0 x 17	8	
40196	31,5 x 22	8,5	



GN Buffetkorb „ECONOMIC“

GN basket
GN cesta
GN corbeille



	cm	↑ cm	GN	Farbe / Colour
40148	53 x 32,5	8	1/1	



GN Buffetkorb „ECONOMIC“

GN basket
GN cesta
GN corbeille



	cm	↑ cm	GN	Farbe / Colour
40152	32,5 x 26,5	8	1/2	

Körbe



Buffetkorb „ECONOMIC“

buffet basket
cesta de buffet
corbeille de buffet



stabile Ausführung mit Edelstahldraht im Rand zur Stabilisierung

very solid with stainless steel wire frame to stabilize the basket

muy resistente con refuerzo de alambre inox

très résistante avec son fil de renfort inox

	cm	↑ cm	GN
40129	53 x 32,5	15,5	1/1

GN Kuppelhaube / GN cover / GN cúpula / GN cloche bombée

	cm	↑ cm
11027	54 x 33	20



Buffetkorb „ECONOMIC“

buffet basket
cesta de buffet
corbeille de buffet



stabile Ausführung mit Edelstahldraht im Rand zur Stabilisierung

very solid with stainless steel wire frame to stabilize the basket

muy resistente con refuerzo de alambre inox

très résistante avec son fil de renfort inox

	cm	↑ cm
40153	45 x 42	17 / 24



Buffetkorb, rund „ECONOMIC“

buffet basket, round
cesta de buffet, redonda
corbeille de buffet ronde



stabile Ausführung mit Edelstahldraht im Rand zur Stabilisierung

very solid with stainless steel wire frame to stabilize the basket

muy resistente con refuerzo de alambre inox

très résistante avec son fil de renfort inox

	Ø cm	↑ cm	Farbe / Colour
40149	40	12,5	
40295	40	12,5	

Rolltophaube / rolltop cover / campana abatible / cloche basculante

	Ø cm	↑ cm	
18388	38	20	mit verchromtem Kugelgriff with chrome plated handle con pomo cromado / avec bouton chromé
18387	38	20	mit vergoldetem Kugelgriff / gold plated handle pomo dorado / bouton doré
18389	38	20	mit verchromtem Designergriff / with chrome plated designer handle



Buffetkorb „ECONOMIC“

buffet basket
cesta de buffet
corbeille buffet



in Handarbeit geflochten, stabile Ausführung, Edelstahl Fixierungsrahmen, zur Rutschsicherung, ohne Haube

wickerwork, stainless steel fix the cover, without cover

cesta trensada a mano, con marco cromado patentado para fijar y encajar la campana (se entrega sin la campana)

corbeille tressée main, cadre fil acier inoxydable pour fixer la cloche (livré sans la cloche)

	cm	↑ cm	Farbe / Colour
40150	56,5 x 36	10	
40294	56,5 x 36	10	

GN 1/1 Rolltop-Haube / GN 1/1 rolltop cover / GN 1/1 campana abatible
GN 1/1 cloche basculante

	cm	↑ cm	GN	
11008	53 x 32,5	19	1/1	vergoldeter Griff / gold plated handle pomo dorado / bouton doré
11010	53 x 32,5	19	1/1	verchromter Griff / chrome plated handle pomo cromado / bouton chromé
11018	53 x 32,5	17	1/1	mit verchromtem Designergriff with chrome plated designer handle



GN Kuppelhaube

GN cover
GN cúpula
GN cloche bombée



glasklarer Kunststoff, Griff verchromt

clear, chrome knob

transparente, asa cromada

transparente, anse chromée

	cm	↑ cm	GN	
11021	33 x 28	17	1/2	geschlossen / totally closed cerrada / tolement fermée
11022	33 x 28	17	1/2	mit Front-Ausschnitt / one long side cut out gran apertura frontal / grande ouverture frontale
11026	54 x 33	20	1/1	geschlossen / totally closed cerrada / tolement fermée
11027	54 x 33	20	1/1	mit Front-Ausschnitt / one long side cut out gran apertura frontal / grande ouverture frontale
11028	54 x 33	20	1/1	mit seitlichem Ausschnitt one small side cut out pequeña apertura lateral / petite ouverture latérale



GN Abdeckhaube

GN cover
GN cubierta
GN cloche



passend für GN Tablets, glasklarer Kunststoff, nahezu unzerbrechlich
suitable for GN trays, clear plastic, nearly unbreakable
apto para bandejas GN, plástico transparente, muy resistente a la rotura
pour bacs et plateaux GN, plastique transparent, très résistant à la casse



	cm	↑ cm	mm	GN
11043	32,5 x 17,6	10,5	3	1/3
11044	53,0 x 16,2	10,5	3	2/4

	cm	↑ cm	mm	GN
11041	32,5 x 26,5	9,5	3	1/2
11042	53,0 x 32,5	9,5	3	1/1

Körbe



Buffetgestell für Körbe

buffet stand for baskets
expositor para cestas
support pour corbeilles



2-stufig, für 2 rechteckige Körbe, platzsparend zusammenklappbar, Lieferung ohne Körbe

2-tier, for 2 rectangular baskets, can be folded, place saving, delivery without baskets

2 alturas, para 2 cestas rectangulares, totalmente plegable para ahorrar espacio, se entrega sin cestas

2 hauteurs, pour 2 corbeilles rectangulaires, pliable pour son rangement, livré sans corbeilles

	cm	↑ cm
33221	46 x 24	18 - 21

Tisch- und Buffetkorb rechteckig „BASIC“ / buffet basket, square / cesta de buffet, cuadrada / corbeille de buffet, carré

	cm	↑ cm	Farbe / Colour
30286	30 x 22	7	
30288	40 x 29	7	

Tisch- und Buffetkorb, eckig „ECONOMIC“ / buffet basket rectangular / cesta de buffet, rectangular / corbeille de buffet rectangulaire

	cm	↑ cm	Farbe / Colour
40159	31,5 x 22	8,5	

Korb „GN LINE“ / GN basket / GN cesta / GN corbeille

	cm	↑ cm	Farbe / Colour
40222	32,5 x 26,5	6,5	
40242	32,5 x 26,5	10,0	
40262	32,5 x 26,5	6,5	
40272	32,5 x 26,5	10,0	



Buffetgestell „DOPPELDECKER“ für GN

buffet frame for GN
estructura para buffet para GN
support buffet pour GN



2-teilig, einfach zusammensetzbar, Etagen-Abstand ca. 26 cm, platzsparend, stabile Ausführung

2 pcs., easy to assemble, distance between the tiers approx. 26 cm, space-saving, robust

2 pzas, fácil de montar, distancia entre pisos aprox. 26 cm, robusto

2 pcs, assemblage facile, distance entre niveaux approx. 26 cm, robuste

	cm	↑ cm	fits to GN
11555	50 x 34	37,5	1/1
11553	29 x 27	35,0	1/2





Buffetgestell

buffet stand
soporte para buffet
présentoir buffet



3-stufig, geeignet für runde und rechteckige Körbe, platzsparend zusammenklappbar
3-tier, usable for round and rectangular baskets, can be pushed together for place saving
3 alturas, apto para cestas redondas y rectangulares, se puede plegar para ahorrar espacio
3 hauteurs, pour corbeilles rondes ou rectang, la structure s'ouvre ou se ferme pour réduire l'encombrement

	cm	↑ cm
33232	59 x 30,5	59

Tisch- und Buffetkorb, rund „ECONOMIC“ / buffet basket, round / cesta de bufé redonda / corbeille de buffet ronde

	Ø cm	↑ cm	Farbe / Colour
40144	39	10	



Baguettekorb „ECONOMIC“

baguette basket
cesta para baguette
corbeille pour baguettes



stabile Ausführung mit Edelstahldraht im Rand zur Stabilisierung
very solid with stainless steel wire frame to stabilize the basket
muy resistente con refuerzo de alambre inox
très résistante avec son fil de renfort inox

	Ø cm	↑ cm	Farbe / Colour
40198	35	24 / 42	

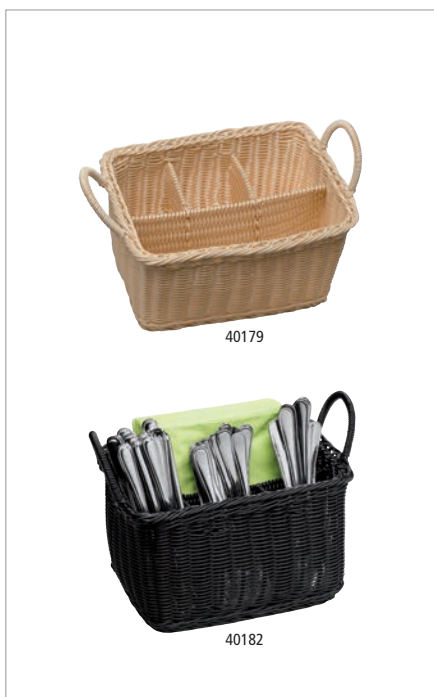

Besteckkorb „ECONOMIC“

cutlery dispenser
dispensador de cubiertos
corbeille à couverts



4 Fächer, 3 kleine Fächer, 1 großes Fach
4 troughs
4 huecos
4 classements

	cm	↑ cm	Farbe / Colour
40179	26 x 18	15	
40182	26 x 18	15	

Körbe



Brot- und Obstkorb „WICKER LOOK“

basket for bread or fruits
cesta para pan o fruta
corbeille à pain ou à fruits



	Ø cm	↑ cm	Farbe / Colour
40214	20	6,5	■
40216	23 x 17	6,5	■

	cm	↑ cm	Farbe / Colour
40211	39,5 x 29,5	10	■
40212	39,5 x 29,5	10	■
40210	39,5 x 29,5	10	■



Besteckkorb „ECONOMIC“

cutlery dispenser
dispensador de cubiertos
corbeille à couverts



in Handarbeit geflochten
wickerwork
trensado a mano
tressage à main

	Ø cm	↑ cm	Farbe / Colour
40130	12	15	■
40007	12	15	■
40012	12	15	■
40013	12	15	■



Besteckkorb „ECONOMIC“

cutlery dispenser
dispensador de cubiertos
corbeille à couverts



in Handarbeit geflochten
wickerwork
trensado a mano
tressage à main

	cm	↑ cm	Farbe / Colour
40131	27 x 10	4,5	■
40009	27 x 10	4,5	■
40010	27 x 10	4,5	■
40011	27 x 10	4,5	■



- in Handarbeit geflochten, einfache und leichte Ausführung
- wickerwork, simple and light version
- ligera, trensada a mano
- tressé à main, version légère



Brot- und Obstkorb oval „BASIC“
 basket for bread or fruits
 cesta para pan o fruta
 corbeille à pain ou à fruits



	cm	↑ cm
30279	18 x 12	7
30280	23 x 15	6



Brot- und Obstkorb oval „BASIC“
 basket for bread or fruits
 cesta para pan o fruta
 corbeille à pain ou à fruits



	cm	↑ cm
30282	21 x 10	6
30284	36 x 15	7



Brot- und Obstkorb rund „BASIC“
 basket for bread or fruits
 cesta para pan o fruta
 corbeille à pain ou à fruits



	Ø cm	↑ cm
30281	20	7
30285	25	7



Tisch- und Buffetkorb rechteckig „BASIC“
 buffet basket
 cesta de buffet
 corbeille de buffet



	cm	↑ cm
30286	30 x 22	7
30288	41 x 29	7
30283	22 x 15	6



Brot- und Obstkorb quadratisch „BASIC“
 basket for bread or fruits
 cesta para pan o fruta
 corbeille à pain ou à fruits



	cm	↑ cm
30287	24 x 24	6

Brottasche

Umgekrempelt kann die Höhe individuell gestaltet werden!



Brottasche bread basket panera corbeille



70% Naturfaser und 30% Kunstharz
70% natural fibre and 30% synthetic resin
70% fibra natural y 30% resina sintética
70% de fibres naturelles et 30% de résine synthétique

	Ø cm	↑ cm	Farbe / Colour
30440	17	11	■
30450	20	13	■
30442	24	24	■
30443	30	22	■
30441	17	11	■
30451	20	13	■
30445	24	24	■
30446	30	22	■



Brottasche bread basket panera corbeille



70% Naturfaser und 30% Kunstharz
70% natural fibre and 30% synthetic resin
70% fibra natural y 30% resina sintética
70% de fibres naturelles et 30% de résine synthétique

	cm	↑ cm	Farbe / Colour
30444	30 x 20	18	■
30447	30 x 20	18	■

umgekrempelt kann die Höhe individuell gestaltet werden
adjustable height by turning the edge upside down
altura ajustable girando el borde al revés
hauteur ajustable en tournant le bord à l'envers

NEW



30355



30356

Brottasche

bread basket
panera
corbeille



70% Naturfaser und 30% Kunstharz

70% natural fibre and 30% synthetic resin

70% fibra natural y 30% resina sintética

70% de fibres naturelles et 30% de résine synthétique

	cm	↑ cm	Farbe / Colour
30355	12 x 11,5	11,5	■ ■ ■ ■ ■
30356	12 x 11,5	13,5	■ ■ ■ ■ ■



30355

umgekrempelt kann die Höhe individuell gestaltet werden
adjustable height by turning the edge upside down
altura ajustable girando el borde al revés
hauteur ajustable en tournant le bord à l'envers

NEW



30345

rund



30346

rund

Brottasche

bread basket
panera
corbeille



	Ø cm	↑ cm	Farbe / Colour
30345	17	11,5	■ ■ ■ ■ ■
30346	20	13,5	■ ■ ■ ■ ■



30346

schmutzabweisende Kunstfaser, 30°C waschbar
dirt-repellent synthetic fibre, washable 30°C
fibra sintética repelente a la suciedad, lavable a 30°C
fibre synthétique anti-salissante, lavable à 30°C

NEW



30347



30348

Brottasche

bread basket
panera
corbeille



	cm	↑ cm	Farbe / Colour
30347	19 x 11	10,5	■ ■ ■ ■ ■
30348	24 x 16	10,5	■ ■ ■ ■ ■



30347

schmutzabweisende Kunstfaser, 30°C waschbar
dirt-repellent synthetic fibre, washable 30°C
fibra sintética repelente a la suciedad, lavable a 30°C
fibre synthétique anti-salissante, lavable à 30°C

Körbe



Brottasche bread basket panera corbeille à pain en toile

BAUM-
WOLLE
COTTON

Baumwolle, umgekrempelt kann die Höhe individuell gestaltet werden, maschinenwaschbar bis 30°C, rund oder oval

cotton, adjustable height, mashine-washable 30°C, round or oval

algodón, altura ajustable, lavable a máquina 30°C, redondo u oval

coton, hauteur ajustable, lavable en machine maxi 30°C, rond ou ovale

	Ø cm	↑ cm	Farbe / Colour
30340	17	11	Yellow
30350	20	12	Yellow
30341	17	11	Black & Yellow
30351	20	12	Black & Yellow
30360	20 x 15	10	Yellow
30370	25 x 18	12	Yellow
30361	20 x 15	10	Black & Yellow
30371	25 x 18	12	Black & Yellow



Brottasche mit Wärmekissen bread basket with stones pillow panera con cojín corbeille à pain en toile avec coussin chauffant

BAUM-
WOLLE
COTTON

Baumwolle, Keramik-Kugeln, maschinenwaschbar bis 30°C

cotton, ceramic stones, mashine-washable 30°C

algodón, bolas de cerámica, lavable a máquina 30°C

coton, billes de céramiques, lavable en machine maxi 30°C

	Ø cm	↑ cm	Farbe / Colour
30380	19	23	Yellow
30390	19	23	Yellow & Brown

Wärmekissen / stones pillow / cojín de piedrecillas a calentar / coussin de petites pierres, à chauffer

	Ø cm	↑ cm
30385	19	1,5



Eierkorb „PROFI LINE“

egg basket
cesta de huevos
panier à oeufs

PP POLYPROPYLEN
EDELSTAHL STAINLESS INOX

mit Edelstahldraht im Rand, für ca. 20 Eier, hält den Inhalt durch das Stoff-Futter lange warm

willow, stable, for around 20 eggs, keeps eggs warm

ratán, calidad fuerte, para unos 20 huevos, mantiene los huevos calientes

rotin, résistant, belle qualité, pour environ 20 oeufs, pour maintenir les oeufs bien chauds

	Ø cm	↑ cm	Farbe / Colour
40299	26	17	Black & Brown



Eierkorb

egg basket
cesta de huevos
panier à oeufs

RATTAN NATUR

stabile Vollweide, für ca. 20 Eier, hält den Inhalt durch das Stoff-Futter lange warm

willow, stable, for around 20 eggs, keeps eggs warm

ratán, calidad fuerte, para unos 20 huevos, mantiene los huevos calientes

rotin, résistant, belle qualité, pour environ 20 oeufs, pour maintenir les oeufs bien chauds

	Ø cm	↑ cm	Farbe / Colour
30299	26	17	Yellow



Schale

bowl
cuenco
bol



gehämmerte Oberfläche

hammered (surface)
superficie martillada
surface martelée

	cm	↑ cm	ltr.	Farbe / Colour
40690	15,5 x 12,0	5,5	0,7	gold look
40693	23,0 x 15,5	6,0	1,4	gold look



Schale

bowl
cuenco
bol



gehämmerte Oberfläche

hammered (surface)
superficie martillada
surface martelée

	cm	↑ cm	ltr.	Farbe / Colour
40691	15,5 x 12,0	5,5	0,7	copper look
40694	23,0 x 15,5	6,0	1,4	copper look



Schale

bowl
cuenco
bol



gehämmerte Oberfläche

hammered (surface)
superficie martillada
surface martelée

	cm	↑ cm	ltr.	Farbe / Colour
40692	15,5 x 12,0	5,5	0,7	gunmetal-look
40695	23,0 x 15,5	6,0	1,4	gunmetal-look



Servierkorb „BURGER & FRIES“

serving basket
cesta para servir
corbeille de service



Servierkorb aus Metall mit 2 Halter für Dipschälchen

metal serving basket with 2 holders for dip bowls
cesta de metal para servir con 2 soportes para cuencos para dip
corbeille de service en métal avec 2 supports pour ramequins

	cm	↑ cm
40604	39,5 x 20	11

passende Schälchen / fitting bowls / cuencos adecuados / bols apropiés





	Ø cm	↑ cm	ltr.
83781	7	3,7	0,05

Servierbeispiel - Lieferung ohne Schälchen
delivery without bowls

Körbe





Korb „URBAN“
basket
cesta
corbeille

METALL  

	∅ cm	↑ cm	Farbe / Colour
30410	17	7,0	■
30411	20	8,5	■





Korb „URBAN“
basket
cesta
corbeille

METALL  

	cm	↑ cm	Farbe / Colour
30412	21 x 10	7	■
30413	30 x 14	12	■



GN Korb „URBAN“
GN basket
GN cesta
GN corbeille

METALL  GN  

	cm	↑ cm	GN	Farbe / Colour
30414	53,0 x 32,5	7,5	1/1	■
30415	32,5 x 26,5	7,5	1/2	■
30416	53,0 x 16,2	7,5	2/4	■

GN Abdeckhaube / GN cover / GN cubierta / GN cloche

	cm	↑ cm	GN	
11044	53 x 16,2	10,5	2/4	
11042	53 x 32,5	9,5	1/1	ohne Abbildung
11022	33 x 28,0	17,0	1/2	ohne Abbildung
11027	54 x 33,0	20,0	1/1	



Brot- und Obstkorb „WIRE“

wire basket
cesta para pan o fruta
corbeille pour pain ou fruits



	Ø cm	↑ cm	Farbe / Colour
30205	31	14	metal chrome



	Ø cm	↑ cm	Farbe / Colour
30206	31	14	metal black

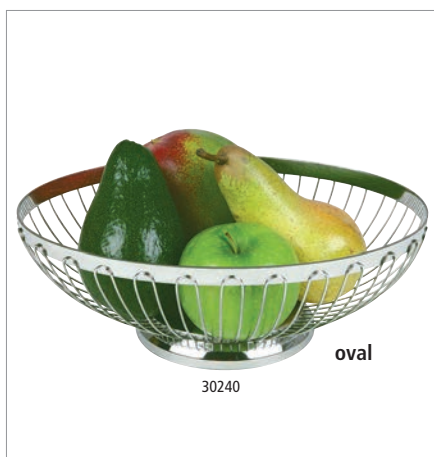

Brot- und Obstkorb

basket for bread or fruits
cesta para pan o fruta
corbeille à pain ou à fruits



hochglanzpoliert
mirror polished finish
acabado pulido brillante
brillant

	Ø cm	↑ cm
30200	17,5	7,0
30220	20,5	8,5
30230	25,5	9,5



Brot- und Obstkorb

basket for bread or fruits
cesta para pan o fruta
corbeille à pain ou à fruits



hochglanzpoliert
mirror polished finish
acabado pulido brillante
brillant

	cm	↑ cm
30210	20 x 15	7,0
30240	24 x 19	8,5
30250	28 x 21	9,5

Obstkorb

basket for fruits
cesta para fruta
corbeille à fruits



hochglanzpoliert
mirror polished finish
acabado pulido brillante
brillant

	Ø cm	↑ cm
30270	21,5	20,5

Körbe baskets

Körbe



Brot- und Obstkorb

basket for bread or fruits
cesta para pan o fruta
corbeille à pain ou fruits



	Ø cm	↑ cm		
30207	21	16,5	black	copper-look handle
30208	30	19,0	black	copper-look handle



Schale

bowl
cuenco
bol



gehämmerte Oberfläche
hammered (surface)
superficie martillada
surface martelée

	cm	↑ cm	ltr.
40189	20 x 13,5	5,5	0,30
40190	24 x 16,5	7,0	0,45



Brot- und Obstschale

bowl for bread or fruits
bol para pan o frutas
bol à pain ou à fruits



hochglanzpoliert, Hammerschlag Optik
mirror polished finish, hammered look
acabado pulido efecto espejo, aspecto repujado
brillant, aspect martelé

	Ø cm	↑ cm
30276	16	5,0
30277	20	5,5



Edelstahl-Schale

bowl
bandeja ovalada inox
corbeille ovale inox



ingerollter Rand / rolled edge / borde redondeado / bord roulé

	cm	↑ cm
40110	26,5 x 18,5	4,0
40115	31,0 x 21,0	4,5



Brot- und Obstkorb

basket for bread or fruits
cesta para pan o fruta
corbeille à pain ou fruits



	Ø cm	↑ cm
30310	18	7,5
30320	23	9,0



Buffetständer / -korb „ASIA PLUS“

buffet stand / basket
soporte para buffet / cesta
présentoir buffet / corbeille



	Ø cm	↑ cm	Farbe / Colour
15507	15	10,5	—
15510	15	10,5	—



Buffetständer / -korb „ASIA PLUS“

buffet stand / basket
soporte para buffet / cesta
présentoir buffet / corbeille



	Ø cm	↑ cm	Farbe / Colour
15508	21	10,5	—
15511	21	10,5	—



Buffetständer / -korb „ASIA PLUS“

buffet stand / basket
soporte para buffet / cesta
présentoir buffet / corbeille



	Ø cm	↑ cm	Farbe / Colour
15509	21	20	—
15512	21	20	—

Körbe



Korb / Ständer „BASKET“

basket / riser
cesta / soporte
corbeille / support



	Ø cm	↑ cm	Farbe / Colour
15321	21 / 15	11	
15325	21 / 15	11	
15323	21 / 15	11	



Korb / Ständer „BASKET“

basket / riser
cesta / soporte
corbeille / support



	Ø cm	↑ cm	Farbe / Colour
15320	10,5 / 8	8	
15324	10,5 / 8	8	
15322	10,5 / 8	8	



Korb / Ständer „BASKET“

basket / riser
cesta / soporte
corbeille / support



Chrom poliert
polished chrome
color plata brillante
chrome poli

	Ø cm	↑ cm	Farbe / Colour
15331	15	10,5	
15332	21	20,0	



Korb / Ständer „BASKET“

basket / riser
cesta / soporte
corbeille / support



Gold, gebürstet
brushed gold
dorado cepillado
doré brossé

	Ø cm	↑ cm	Farbe / Colour
15334	15	10,5	
15335	21	20,0	



Korb / Ständer „BASKET“

basket / riser
cesta / soporte
corbeille / support



	Ø cm	↑ cm	Farbe / Colour
15326	21 / 15	21	■



Box „BROTSTATION“

box
caja de pan para buffet
boîte à pain pour le buffet



Buchen-Holz

beech
haya
hêtre

	cm	↑ cm
00959	34 x 26	12,5
00954	34 x 26	20,0

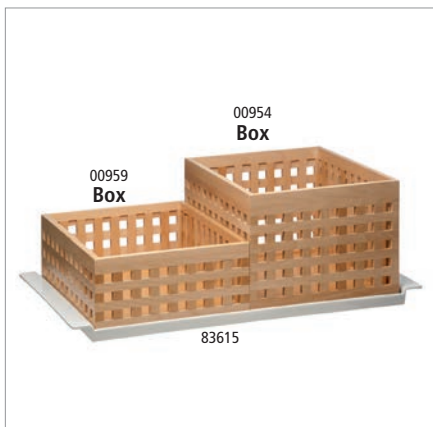

Tablett „BROTSTATION“

tray
bandeja
plateau



Antirutsch-Füßchen

non-slip feet
pies antideslizantes
pieds antidérapants

	cm	↑ cm
83615	59,5 x 35,5	3,5



Brot Schneidebrett „BROTSTATION“

cutting board
tabla de corte
planche à découper



Buchen-Holz

beech
haya
hêtre

	cm	↑ cm
00953	52 x 34	2

	cm	↑ cm
83615	59,5 x 35,5	3,5